



Bid Number/बोली क्रमांक (बिड संख्या):  
GEM/2024/B/5278726  
Dated/दिनांक : 20-08-2024

### Bid Document/ बिड दस्तावेज़

Bid Details/बिड विवरण	
Bid End Date/Time/बिड बंद होने की तारीख/समय	10-09-2024 14:00:00
Bid Opening Date/Time/बिड खुलने की तारीख/समय	10-09-2024 14:30:00
Bid Offer Validity (From End Date)/बिड पेशकश वैधता (बंद होने की तारीख से)	120 (Days)
Ministry/State Name/मंत्रालय/राज्य का नाम	Ministry Of Defence
Department Name/विभाग का नाम	Department Of Defence Production
Organisation Name/संगठन का नाम	Mazagon Dock Shipbuilders Limited
Office Name/कार्यालय का नाम	*****
Total Quantity/कुल मात्रा	9209600
Item Category/मद केटेगरी	Item No 1 Material Code 18700023 , Item No 2 Material Code 18700024 , Item No 3 Material Code 18700030 , Item No 4 Material Code 18701579 , Item No 5 Material Code 18701580 , Item No 6 Material Code 18701581 , Item No 7 Material Code 18703716 , Item No 8 Material Code 18701961 , Item No 9 Material Code 18701991 , Item No 10 Material Code 18701992 , Item No 11 Material Code 18701993 , Item No 12 Material Code 18701994 , Item No 13 Material Code 18701995 , Item No 14 Material Code 18701996 , Item No 15 Material Code 18701997 , Item No 16 Material Code 18701998 , Item No 17 Material Code 18701999 , Item No 18 Material Code 18701589 , Item No 19 Material Code 18703225 , Item No 20 Material Code 18703226 , Item No 21 Material Code 18703227 , Item No 22 Material Code 18703228 , Item No 23 Material Code 18703229 , Item No 24 Material Code 18703230 , Item No 25 Material Code 18703231 , Item No 26 Material Code 18701962 , Item No 27 Material Code 18701578 , Item No 28 Material Code 18703111 , Item No 29 Material Code 18703221 , Item No 30 Material Code 18707426 , Item No 31 Material Code 18703041 , Item No 32 Material Code 18701576 , Item No 33 Material Code 18703211
BOQ Title/बीओक्यू शीर्षक	BOLT NUT SCREW AND WASHER
MSE Exemption for Years Of Experience/अनुभव के वर्षों से एमएसई छूट/ and Turnover/टर्नओवर के लिए एमएसई को छूट प्राप्त है	Yes

<b>Bid Details/बिड विवरण</b>	
<b>Startup Exemption for Years Of Experience/अनुभव के वर्षों से स्टार्टअप छूट/ and Turnover/ टर्नओवर के लिए स्टार्टअप को छूट प्राप्त है</b>	Yes
<b>Document required from seller/विक्रेता से मांगे गए दस्तावेज़</b>	Additional Doc 1 (Requested in ATC),Additional Doc 2 (Requested in ATC),Additional Doc 3 (Requested in ATC) *In case any bidder is seeking exemption from Experience / Turnover Criteria, the supporting documents to prove his eligibility for exemption must be uploaded for evaluation by the buyer
<b>Bid to RA enabled/बिड से रिवर्स नीलामी सक्रिय किया</b>	No
<b>ITC available to buyer/क्रिता के लिए उपलब्ध आईटीसी</b>	Yes
<b>Type of Bid/बिड का प्रकार</b>	Two Packet Bid
<b>Primary product category</b>	Item No 1 Material Code 18700023
<b>Time allowed for Technical Clarifications during technical evaluation/तकनीकी मूल्यांकन के दौरान तकनीकी स्पष्टीकरण हेतु अनुमत समय</b>	2 Days
<b>Inspection Required (By Empanelled Inspection Authority / Agencies pre-registered with GeM)</b>	No
<b>Payment Timelines</b>	Payments shall be made to the Seller within <b>15</b> days of issue of consignee receipt-cum-acceptance certificate (CRAC) and on-line submission of bills (This is in supersession of 10 days time as provided in clause 12 of GeM GTC)
<b>Evaluation Method/मूल्यांकन पद्धति</b>	Item wise evaluation/

#### **EMD Detail/ईएमडी विवरण**

Advisory Bank/एडवाइजरी बैंक	State Bank of India
Schedule 1 EMD Amount/ईएमडी राशि (In INR)	13695
Schedule 2 EMD Amount/ईएमडी राशि (In INR)	4122
Schedule 3 EMD Amount/ईएमडी राशि (In INR)	108790
Schedule 4 EMD Amount/ईएमडी राशि (In INR)	2783
Schedule 5 EMD Amount/ईएमडी राशि (In INR)	117600
Schedule 6 EMD Amount/ईएमडी राशि (In INR)	67904
Schedule 7 EMD Amount/ईएमडी राशि (In INR)	853
Schedule 8 EMD Amount/ईएमडी राशि (In INR)	1165
Schedule 9 EMD Amount/ईएमडी राशि (In INR)	453600

Schedule 10 EMD Amount/ईएमडी राशि (In INR)	152880
Schedule 11 EMD Amount/ईएमडी राशि (In INR)	67940
Schedule 12 EMD Amount/ईएमडी राशि (In INR)	98700
Schedule 13 EMD Amount/ईएमडी राशि (In INR)	32130
Schedule 14 EMD Amount/ईएमडी राशि (In INR)	56700
Schedule 15 EMD Amount/ईएमडी राशि (In INR)	24960
Schedule 16 EMD Amount/ईएमडी राशि (In INR)	27520
Schedule 17 EMD Amount/ईएमडी राशि (In INR)	30720
Schedule 18 EMD Amount/ईएमडी राशि (In INR)	10920
Schedule 19 EMD Amount/ईएमडी राशि (In INR)	43365
Schedule 20 EMD Amount/ईएमडी राशि (In INR)	10500
Schedule 21 EMD Amount/ईएमडी राशि (In INR)	2944
Schedule 22 EMD Amount/ईएमडी राशि (In INR)	1058
Schedule 23 EMD Amount/ईएमडी राशि (In INR)	39102
Schedule 24 EMD Amount/ईएमडी राशि (In INR)	10500
Schedule 25 EMD Amount/ईएमडी राशि (In INR)	2944
Schedule 26 EMD Amount/ईएमडी राशि (In INR)	19998
Schedule 27 EMD Amount/ईएमडी राशि (In INR)	4781
Schedule 28 EMD Amount/ईएमडी राशि (In INR)	2185
Schedule 29 EMD Amount/ईएमडी राशि (In INR)	2113
Schedule 30 EMD Amount/ईएमडी राशि (In INR)	4848
Schedule 31 EMD Amount/ईएमडी राशि (In INR)	3096
Schedule 32 EMD Amount/ईएमडी राशि (In INR)	2079
Schedule 33 EMD Amount/ईएमडी राशि (In INR)	1040

#### ePBG Detail/ईपीबीजी विवरण

Advisory Bank/एडवाइजरी बैंक	State Bank of India
ePBG Percentage(%) / ईपीबीजी प्रतिशत (%)	5.00

Duration of ePBG required (Months)/ईपीबीजी की अपेक्षित अवधि (महीने).

14

(a). EMD EXEMPTION: The bidder seeking EMD exemption, must submit the valid supporting document for the relevant category as per GeM GTC with the bid. Under MSE category, only manufacturers for goods and Service Providers for Services are eligible for exemption from EMD. Traders are excluded from the purview of this Policy./जेम की शर्तों के अनुसार ईएमडी छूट के इच्छुक बिडर को संबंधित केटेगरी के लिए बिड के साथ वैध समर्थित दस्तावेज़ प्रस्तुत करने हैं। एमएसई केटेगरी के अंतर्गत केवल वस्तुओं के लिए विनिर्माता तथा सेवाओं के लिए सेवा प्रदाता ईएमडी से छूट के पात्र हैं। व्यापारियों को इस नीति के दायरे से बाहर रखा गया है।

(b). The EMD Amount will be applicable for each schedule/group selected during Bid creation.

(c). EMD & Performance security should be in favour of Beneficiary, wherever it is applicable./ईएमडी और संपादन जमानत राशि, जहां यह लागू होती है, लाभार्थी के पक्ष में होनी चाहिए।

**Beneficiary/लाभार्थी :**

GM(M)

Mumbai, Department of Defence Production, Mazagon Dock Shipbuilders Limited, Ministry of Defence  
(Hare Ram Singh)

**MII Purchase Preference/एमआईआई खरीद वरीयता**

MII Purchase Preference/एमआईआई खरीद वरीयता

Yes

**Reserved for MSE**

Reserved for MSE

Yes

1. If the bidder is a Micro or Small Enterprise as per latest definitions under MSME rules, the bidder shall be exempted from the requirement of "Bidder Turnover" criteria and "Experience Criteria" subject to meeting of quality and technical specifications. If the bidder is OEM of the offered products, it would be exempted from the "OEM Average Turnover" criteria also subject to meeting of quality and technical specifications. In case any bidder is seeking exemption from Turnover / Experience Criteria, the supporting documents to prove his eligibility for exemption must be uploaded for evaluation by the buyer.
2. If the bidder is a Startup, the bidder shall be exempted from the requirement of "Bidder Turnover" criteria and "Experience Criteria" subject to their meeting of quality and technical specifications. If the bidder is OEM of the offered products, it would be exempted from the "OEM Average Turnover" criteria also subject to meeting of quality and technical specifications. In case any bidder is seeking exemption from Turnover / Experience Criteria, the supporting documents to prove his eligibility for exemption must be uploaded for evaluation by the buyer.
3. Preference to Make In India products (For bids < 200 Crore):Preference shall be given to Class 1 local supplier as defined in public procurement (Preference to Make in India), Order 2017 as amended from time to time and its subsequent Orders/Notifications issued by concerned Nodal Ministry for specific Goods/Products. The minimum local content to qualify as a Class 1 local supplier is denoted in the bid document. If the bidder wants to avail the Purchase preference, the bidder must upload a certificate from the OEM regarding the percentage of the local content and the details of locations at which the local value addition is made along with their bid, failing which no purchase preference shall be granted. In case the bid value is more than Rs 10 Crore, the declaration relating to percentage of local content shall be certified by the statutory auditor or cost auditor, if the OEM is a company and by a practicing cost accountant or a chartered accountant for OEMs other than companies as per the Public Procurement (preference to Make-in -India) order 2017 dated 04.06.2020. Only Class-I and Class-II Local suppliers as per MII order dated 4.6.2020 will be eligible to bid. Non - Local suppliers as per MII order dated 04.06.2020 are not eligible to participate. However, eligible micro and small enterprises will be allowed to participate .The

buyers are advised to refer the OM No.F.1/4/2021-PPD dated 18.05.2023.

[OM No.1 4 2021 PPD dated 18.05.2023](#) for compliance of Concurrent application of Public Procurement Policy for Micro and Small Enterprises Order, 2012 and Public Procurement (Preference to Make in India) Order, 2017.

4. Procurement under this bid is reserved for purchase from Micro and Small Enterprises having valid Udyam Registration and whose credentials are validated online through Udyam Registration portal. If the bidder wants to avail themselves of the reservation benefit, the bidder must be the manufacturer / OEM of the offered product on GeM. Traders are excluded from the purview of Public Procurement Policy for Micro and Small Enterprises and hence resellers offering products manufactured by some other OEM are not eligible to participate in this bid. In respect of bid for Services, the bidder must be the Service provider of the offered Service. Relevant documentary evidence in this regard shall be uploaded along with the bid in respect of the offered product or service, and Buyer will decide eligibility based on documentary evidence submitted, while evaluating the bid. Benefits of MSE will be allowed only if seller is validated on-line in GeM profile as well as validated and approved by Buyer after evaluation of documents submitted.

5. Estimated Bid Value indicated above is being declared solely for the purpose of guidance on EMD amount and for determining the Eligibility Criteria related to Turn Over, Past Performance and Project / Past Experience etc. This has no relevance or bearing on the price to be quoted by the bidders and is also not going to have any impact on bid participation. Also this is not going to be used as a criteria in determining reasonableness of quoted prices which would be determined by the buyer based on its own assessment of reasonableness and based on competitive prices received in Bid / RA process.

#### **Evaluation Method ( Item Wise Evaluation Method )**

Contract will be awarded schedulewise and the determination of L1 will be done separately for each schedule. The details of item-consignee combination covered under each schedule are as under:

<b>Evaluation Schedules</b>	<b>Item/Category</b>	<b>Quantity</b>
Schedule 1	Item No 1 Material Code 18700023	52500
Schedule 2	Item No 2 Material Code 18700024	21000
Schedule 3	Item No 3 Material Code 18700030	236500
Schedule 4	Item No 4 Material Code 18701579	74000
Schedule 5	Item No 5 Material Code 18701580	1470000
Schedule 6	Item No 6 Material Code 18701581	263000
Schedule 7	Item No 7 Material Code 18703716	73500
Schedule 8	Item No 8 Material Code 18701961	10000
Schedule 9	Item No 9 Material Code 18701991	945000
Schedule 10	Item No 10 Material Code 18701992	294000
Schedule 11	Item No 11 Material Code 18701993	79000
Schedule 12	Item No 12 Material Code 18701994	105000
Schedule 13	Item No 13 Material Code 18701995	31500
Schedule 14	Item No 14 Material Code 18701996	52500
Schedule 15	Item No 15 Material Code 18701997	16000
Schedule 16	Item No 16 Material Code 18701998	16000
Schedule 17	Item No 17 Material Code 18701999	16000
Schedule 18	Item No 18 Material Code 18701589	42000
Schedule 19	Item No 19 Material Code 18703225	1470000

Schedule 20	Item No 20 Material Code 18703226	262500
Schedule 21	Item No 21 Material Code 18703227	36800
Schedule 22	Item No 22 Material Code 18703228	73500
Schedule 23	Item No 23 Material Code 18703229	1470000
Schedule 24	Item No 24 Material Code 18703230	262500
Schedule 25	Item No 25 Material Code 18703231	36800
Schedule 26	Item No 26 Material Code 18701962	560000
Schedule 27	Item No 27 Material Code 18701578	160000
Schedule 28	Item No 28 Material Code 18703111	160000
Schedule 29	Item No 29 Material Code 18703221	160000
Schedule 30	Item No 30 Material Code 18707426	100000
Schedule 31	Item No 31 Material Code 18703041	280000
Schedule 32	Item No 32 Material Code 18701576	280000
Schedule 33	Item No 33 Material Code 18703211	100000

### Item No 1 Material Code 18700023

**(Minimum 50% and 20% Local Content required for qualifying as Class 1 and Class 2 Local Supplier respectively/क्रमशः श्रेणी 1 और श्रेणी 2 के स्थानीय आपूर्तिकर्ता के रूप में अर्हता प्राप्त करने के लिए आवश्यक)**

### Technical Specifications/तकनीकी विशिष्टियाँ

<b>Specification Document</b>	<a href="#">View File</a>
<b>BOQ Detail Document</b>	<a href="#">View File</a>

Advisory-Please refer attached BOQ document for detailed consignee list and delivery period.

### Input Tax Credit(ITC)/इनपुट कर क्रेडिट(आईटीसी) and/ तथा Reverse Charge(RCM)/रिवर्स प्रभार (आरसीएम) Details

ITC on GST/जीएसटी पर इनपुट कर क्रेडिट	ITC on GST Cess/जीएसटी उपकर कर क्रेडिट
100%	NA

### Consignees/Reporting Officer/परेषिती/रिपोर्टिंग अधिकारी and/ तथा Quantity/मात्रा

S.No./क्र. सं.	Consignee Reporting/Officer/ परेषिती/रिपोर्टिंग अधिकारी	Address/पता	Quantity/मात्रा	Delivery Days/डिलीवरी के दिन
1	*****	*****Mumbai	52500	45

### Item No 2 Material Code 18700024

(Minimum 50% and 20% Local Content required for qualifying as Class 1 and Class 2 Local Supplier respectively/क्रमशः श्रेणी 1 और श्रेणी 2 के स्थानीय आपूर्तिकर्ता के रूप में अर्हता प्राप्त करने के लिए आवश्यक)

#### Technical Specifications/तकनीकी विशिष्टियाँ

Specification Document	<a href="#">View File</a>
BOQ Detail Document	<a href="#">View File</a>

Advisory-Please refer attached BOQ document for detailed consignee list and delivery period.

#### Input Tax Credit(ITC)/इनपुट कर क्रेडिट(आईटीसी) and/ तथा Reverse Charge(RCM)/रिवर्स प्रभार (आरसीएम) Details

ITC on GST/जीएसटी पर इनपुट कर क्रेडिट	ITC on GST Cess/जीएसटी उपकर कर क्रेडिट
100%	NA

#### Consignees/Reporting Officer/परेषिती/रिपोर्टिंग अधिकारी and/ तथा Quantity/मात्रा

S.No./क्र. सं.	Consignee Reporting/Officer/ परेषिती/रिपोर्टिंग अधिकारी	Address/पता	Quantity/मात्रा	Delivery Days/डिलीवरी के दिन
1	*****	*****Mumbai	21000	45

### Item No 3 Material Code 18700030

(Minimum 50% and 20% Local Content required for qualifying as Class 1 and Class 2 Local Supplier respectively/क्रमशः श्रेणी 1 और श्रेणी 2 के स्थानीय आपूर्तिकर्ता के रूप में अर्हता प्राप्त करने के लिए आवश्यक)

#### Technical Specifications/तकनीकी विशिष्टियाँ

Specification Document	<a href="#">View File</a>
BOQ Detail Document	<a href="#">View File</a>

Advisory-Please refer attached BOQ document for detailed consignee list and delivery period.

**Input Tax Credit(ITC)/इनपुट कर क्रेडिट(आईटीसी) and/ तथा Reverse Charge(RCM)/रिवर्स प्रभार (आरसीएम) Details**

ITC on GST/जीएसटी पर इनपुट कर क्रेडिट	ITC on GST Cess/जीएसटी उपकर कर क्रेडिट
100%	NA

**Consignees/Reporting Officer/परेषिती/रिपोर्टिंग अधिकारी and/ तथा Quantity/मात्रा**

S.No./क्र. सं.	Consignee Reporting/Officer/ परेषिती/रिपोर्टिंग अधिकारी	Address/पता	Quantity/मात्रा	Delivery Days/डिलीवरी के दिन
1	*****	*****Mumbai	236500	45

**Item No 4 Material Code 18701579**

**(Minimum 50% and 20% Local Content required for qualifying as Class 1 and Class 2 Local Supplier respectively/क्रमशः श्रेणी 1 और श्रेणी 2 के स्थानीय आपूर्तिकर्ता के रूप में अर्हता प्राप्त करने के लिए आवश्यक)**

**Technical Specifications/तकनीकी विशिष्टियाँ**

Specification Document	<a href="#">View File</a>
BOQ Detail Document	<a href="#">View File</a>

Advisory-Please refer attached BOQ document for detailed consignee list and delivery period.

**Input Tax Credit(ITC)/इनपुट कर क्रेडिट(आईटीसी) and/ तथा Reverse Charge(RCM)/रिवर्स प्रभार (आरसीएम) Details**

ITC on GST/जीएसटी पर इनपुट कर क्रेडिट	ITC on GST Cess/जीएसटी उपकर कर क्रेडिट
100%	NA

**Consignees/Reporting Officer/परेषिती/रिपोर्टिंग अधिकारी and/ तथा Quantity/मात्र**

S.No./क्र. सं.	Consignee Reporting/Officer/ परेषिती/रिपोर्टिंग अधिकारी	Address/पता	Quantity/मात्र	Delivery Days/डिलीवरी के दिन
1	*****	*****Mumbai	74000	45

**Item No 5 Material Code 18701580**

(Minimum 50% and 20% Local Content required for qualifying as Class 1 and Class 2 Local Supplier respectively/क्रमशः श्रेणी 1 और श्रेणी 2 के स्थानीय आपूर्तिकर्ता के रूप में अर्हता प्राप्त करने के लिए आवश्यक)

**Technical Specifications/तकनीकी विशिष्टियाँ**

Specification Document	<a href="#">View File</a>
BOQ Detail Document	<a href="#">View File</a>

Advisory-Please refer attached BOQ document for detailed consignee list and delivery period.

**Input Tax Credit(ITC)/इनपुट कर क्रेडिट(आईटीसी) and/ तथा Reverse Charge(RCM)/रिवर्स प्रभार (आरसीएम) Details**

ITC on GST/जीएसटी पर इनपुट कर क्रेडिट	ITC on GST Cess/जीएसटी उपकर कर क्रेडिट
100%	NA

**Consignees/Reporting Officer/परेषिती/रिपोर्टिंग अधिकारी and/ तथा Quantity/मात्र**

S.No./क्र. सं.	Consignee Reporting/Officer/ परेषिती/रिपोर्टिंग अधिकारी	Address/पता	Quantity/मात्र	Delivery Days/डिलीवरी के दिन
1	*****	*****Mumbai	1470000	45

**Item No 6 Material Code 18701581**

(Minimum 50% and 20% Local Content required for qualifying as Class 1 and Class 2 Local Supplier respectively/क्रमशः श्रेणी 1 और श्रेणी 2 के स्थानीय आपूर्तिकर्ता के रूप में अर्हता प्राप्त करने के लिए आवश्यक)

**Technical Specifications/तकनीकी विशिष्टियाँ**

<b>Specification Document</b>	<a href="#">View File</a>
<b>BOQ Detail Document</b>	<a href="#">View File</a>

Advisory-Please refer attached BOQ document for detailed consignee list and delivery period.

**Input Tax Credit(ITC)/इनपुट कर क्रेडिट(आईटीसी) and/ तथा Reverse Charge(RCM)/रिवर्स प्रभार (आरसीएम) Details**

<b>ITC on GST/जीएसटी पर इनपुट कर क्रेडिट</b>	<b>ITC on GST Cess/जीएसटी उपकर कर क्रेडिट</b>
100%	NA

**Consignees/Reporting Officer/परेषिती/रिपोर्टिंग अधिकारी and/ तथा Quantity/मात्रा**

<b>S.No./क्र. सं.</b>	<b>Consignee Reporting/Officer/ परेषिती/रिपोर्टिंग अधिकारी</b>	<b>Address/पता</b>	<b>Quantity/मात्रा</b>	<b>Delivery Days/डिलीवरी के दिन</b>
1	*****	*****Mumbai	263000	45

**Item No 7 Material Code 18703716**

**(Minimum 50% and 20% Local Content required for qualifying as Class 1 and Class 2 Local Supplier respectively/क्रमशः श्रेणी 1 और श्रेणी 2 के स्थानीय आपूर्तिकर्ता के रूप में अर्हता प्राप्त करने के लिए आवश्यक)**

**Technical Specifications/तकनीकी विशिष्टियाँ**

<b>Specification Document</b>	<a href="#">View File</a>
<b>BOQ Detail Document</b>	<a href="#">View File</a>

Advisory-Please refer attached BOQ document for detailed consignee list and delivery period.

**Input Tax Credit(ITC)/इनपुट कर क्रेडिट(आईटीसी) and/ तथा Reverse Charge(RCM)/रिवर्स प्रभार (आरसीएम) Details**

<b>ITC on GST/जीएसटी पर इनपुट कर क्रेडिट</b>	<b>ITC on GST Cess/जीएसटी उपकर कर क्रेडिट</b>
100%	NA

**Consignees/Reporting Officer/परेषिती/रिपोर्टिंग अधिकारी and/ तथा Quantity/मात्रा**

<b>S.No./क्र. सं.</b>	<b>Consignee Reporting/Officer/ परेषिती/रिपोर्टिंग अधिकारी</b>	<b>Address/पता</b>	<b>Quantity/मात्रा</b>	<b>Delivery Days/डिलीवरी के दिन</b>
1	*****	*****Mumbai	73500	45

**Item No 8 Material Code 18701961**

**(Minimum 50% and 20% Local Content required for qualifying as Class 1 and Class 2 Local Supplier respectively/क्रमशः श्रेणी 1 और श्रेणी 2 के स्थानीय आपूर्तिकर्ता के रूप में अर्हता प्राप्त करने के लिए आवश्यक)**

**Technical Specifications/तकनीकी विशिष्टियाँ**

<b>Specification Document</b>	<a href="#">View File</a>
<b>BOQ Detail Document</b>	<a href="#">View File</a>

Advisory-Please refer attached BOQ document for detailed consignee list and delivery period.

**Input Tax Credit(ITC)/इनपुट कर क्रेडिट(आईटीसी) and/ तथा Reverse Charge(RCM)/रिवर्स प्रभार (आरसीएम) Details**

<b>ITC on GST/जीएसटी पर इनपुट कर क्रेडिट</b>	<b>ITC on GST Cess/जीएसटी उपकर कर क्रेडिट</b>
100%	NA

**Consignees/Reporting Officer/परेषिती/रिपोर्टिंग अधिकारी and/ तथा Quantity/मात्रा**

<b>S.No./क्र. सं.</b>	<b>Consignee Reporting/Officer/ परेषिती/रिपोर्टिंग अधिकारी</b>	<b>Address/पता</b>	<b>Quantity/मात्रा</b>	<b>Delivery Days/डिलीवरी के दिन</b>
1	*****	*****Mumbai	10000	45

**Item No 9 Material Code 18701991**

**(Minimum 50% and 20% Local Content required for qualifying as Class 1 and Class 2 Local Supplier respectively/क्रमशः श्रेणी 1 और श्रेणी 2 के स्थानीय आपूर्तिकर्ता के रूप में अर्हता प्राप्त करने के लिए आवश्यक)**

**Technical Specifications/तकनीकी विशिष्टियाँ**

<b>Specification Document</b>	<a href="#">View File</a>
<b>BOQ Detail Document</b>	<a href="#">View File</a>

Advisory-Please refer attached BOQ document for detailed consignee list and delivery period.

**Input Tax Credit(ITC)/इनपुट कर क्रेडिट(आईटीसी) and/ तथा Reverse Charge(RCM)/रिवर्स प्रभार (आरसीएम) Details**

<b>ITC on GST/जीएसटी पर इनपुट कर क्रेडिट</b>	<b>ITC on GST Cess/जीएसटी उपकर कर क्रेडिट</b>
100%	NA

**Consignees/Reporting Officer/परेषिती/रिपोर्टिंग अधिकारी and/ तथा Quantity/मात्रा**

<b>S.No./क्र. सं.</b>	<b>Consignee Reporting/Officer/ परेषिती/रिपोर्टिंग अधिकारी</b>	<b>Address/पता</b>	<b>Quantity/मात्रा</b>	<b>Delivery Days/डिलीवरी के दिन</b>
1	*****	*****Mumbai	945000	45

**Item No 10 Material Code 18701992**

**(Minimum 50% and 20% Local Content required for qualifying as Class 1 and Class 2 Local Supplier respectively/क्रमशः श्रेणी 1 और श्रेणी 2 के स्थानीय आपूर्तिकर्ता के रूप में अर्हता प्राप्त करने के लिए आवश्यक)**

**Technical Specifications/तकनीकी विशिष्टियाँ**

<b>Specification Document</b>	<a href="#">View File</a>
<b>BOQ Detail Document</b>	<a href="#">View File</a>

Advisory-Please refer attached BOQ document for detailed consignee list and delivery period.

**Input Tax Credit(ITC)/इनपुट कर क्रेडिट(आईटीसी) and/ तथा Reverse Charge(RCM)/रिवर्स प्रभार (आरसीएम) Details**

ITC on GST/जीएसटी पर इनपुट कर क्रेडिट	ITC on GST Cess/जीएसटी उपकर कर क्रेडिट
100%	NA

**Consignees/Reporting Officer/परेषिती/रिपोर्टिंग अधिकारी and/ तथा Quantity/मात्रा**

S.No./क्र. सं.	Consignee Reporting/Officer/ परेषिती/रिपोर्टिंग अधिकारी	Address/पता	Quantity/मात्रा	Delivery Days/डिलीवरी के दिन
1	*****	*****Mumbai	294000	45

**Item No 11 Material Code 18701993**

(Minimum 50% and 20% Local Content required for qualifying as Class 1 and Class 2 Local Supplier respectively/क्रमशः श्रेणी 1 और श्रेणी 2 के स्थानीय आपूर्तिकर्ता के रूप में अर्हता प्राप्त करने के लिए आवश्यक)

**Technical Specifications/तकनीकी विशिष्टियाँ**

Specification Document	<a href="#">View File</a>
BOQ Detail Document	<a href="#">View File</a>

Advisory-Please refer attached BOQ document for detailed consignee list and delivery period.

**Input Tax Credit(ITC)/इनपुट कर क्रेडिट(आईटीसी) and/ तथा Reverse Charge(RCM)/रिवर्स प्रभार (आरसीएम) Details**

ITC on GST/जीएसटी पर इनपुट कर क्रेडिट	ITC on GST Cess/जीएसटी उपकर कर क्रेडिट
100%	NA

**Consignees/Reporting Officer/परेषिती/रिपोर्टिंग अधिकारी and/ तथा Quantity/मात्रा**

S.No./क्र. सं.	Consignee Reporting/Officer/ परेषिती/रिपोर्टिंग अधिकारी	Address/पता	Quantity/मात्रा	Delivery Days/डिलीवरी के दिन
1	*****	*****Mumbai	79000	45

**Item No 12 Material Code 18701994**

(Minimum 50% and 20% Local Content required for qualifying as Class 1 and Class 2 Local Supplier respectively/क्रमशः श्रेणी 1 और श्रेणी 2 के स्थानीय आपूर्तिकर्ता के रूप में अर्हता प्राप्त करने के लिए आवश्यक)

**Technical Specifications/तकनीकी विशिष्टियाँ**

<b>Specification Document</b>	<a href="#">View File</a>
<b>BOQ Detail Document</b>	<a href="#">View File</a>

Advisory-Please refer attached BOQ document for detailed consignee list and delivery period.

**Input Tax Credit(ITC)/इनपुट कर क्रेडिट(आईटीसी) and/ तथा Reverse Charge(RCM)/रिवर्स प्रभार (आरसीएम) Details**

<b>ITC on GST/जीएसटी पर इनपुट कर क्रेडिट</b>	<b>ITC on GST Cess/जीएसटी उपकर कर क्रेडिट</b>
100%	NA

**Consignees/Reporting Officer/परेषिती/रिपोर्टिंग अधिकारी and/ तथा Quantity/मात्रा**

<b>S.No./क्र. सं.</b>	<b>Consignee Reporting/Officer/ परेषिती/रिपोर्टिंग अधिकारी</b>	<b>Address/पता</b>	<b>Quantity/मात्रा</b>	<b>Delivery Days/डिलीवरी के दिन</b>
1	*****	*****Mumbai	105000	45

**Item No 13 Material Code 18701995**

(Minimum 50% and 20% Local Content required for qualifying as Class 1 and Class 2 Local Supplier respectively/क्रमशः श्रेणी 1 और श्रेणी 2 के स्थानीय आपूर्तिकर्ता के रूप में अर्हता प्राप्त करने के लिए आवश्यक)

**Technical Specifications/तकनीकी विशिष्टियाँ**

<b>Specification Document</b>	<a href="#">View File</a>
<b>BOQ Detail Document</b>	<a href="#">View File</a>

Advisory-Please refer attached BOQ document for detailed consignee list and delivery period.

**Input Tax Credit(ITC)/इनपुट कर क्रेडिट(आईटीसी) and/ तथा Reverse Charge(RCM)/रिवर्स प्रभार (आरसीएम) Details**

ITC on GST/जीएसटी पर इनपुट कर क्रेडिट	ITC on GST Cess/जीएसटी उपकर कर क्रेडिट
100%	NA

**Consignees/Reporting Officer/परेषिती/रिपोर्टिंग अधिकारी and/ तथा Quantity/मात्रा**

S.No./क्र. सं.	Consignee Reporting/Officer/ परेषिती/रिपोर्टिंग अधिकारी	Address/पता	Quantity/मात्रा	Delivery Days/डिलीवरी के दिन
1	*****	*****Mumbai	31500	45

**Item No 14 Material Code18701996**

(Minimum 50% and 20% Local Content required for qualifying as Class 1 and Class 2 Local Supplier respectively/क्रमशः श्रेणी 1 और श्रेणी 2 के स्थानीय आपूर्तिकर्ता के रूप में अर्हता प्राप्त करने के लिए आवश्यक)

**Technical Specifications/तकनीकी विशिष्टियाँ**

Specification Document	<a href="#">View File</a>
BOQ Detail Document	<a href="#">View File</a>

Advisory-Please refer attached BOQ document for detailed consignee list and delivery period.

**Input Tax Credit(ITC)/इनपुट कर क्रेडिट(आईटीसी) and/ तथा Reverse Charge(RCM)/रिवर्स प्रभार (आरसीएम) Details**

ITC on GST/जीएसटी पर इनपुट कर क्रेडिट	ITC on GST Cess/जीएसटी उपकर कर क्रेडिट
100%	NA

**Consignees/Reporting Officer/परेषिती/रिपोर्टिंग अधिकारी and/ तथा Quantity/मात्रा**

S.No./क्र. सं.	Consignee Reporting/Officer/ परेषिती/रिपोर्टिंग अधिकारी	Address/पता	Quantity/मात्रा	Delivery Days/डिलीवरी के दिन
1	*****	*****Mumbai	52500	45

#### Item No 15 Material Code 18701997

(Minimum 50% and 20% Local Content required for qualifying as Class 1 and Class 2 Local Supplier respectively/क्रमशः श्रेणी 1 और श्रेणी 2 के स्थानीय आपूर्तिकर्ता के रूप में अर्हता प्राप्त करने के लिए आवश्यक)

#### Technical Specifications/तकनीकी विशिष्टियाँ

Specification Document	<a href="#">View File</a>
BOQ Detail Document	<a href="#">View File</a>

Advisory-Please refer attached BOQ document for detailed consignee list and delivery period.

#### Input Tax Credit(ITC)/इनपुट कर क्रेडिट(आईटीसी) and/ तथा Reverse Charge(RCM)/रिवर्स प्रभार (आरसीएम) Details

ITC on GST/जीएसटी पर इनपुट कर क्रेडिट	ITC on GST Cess/जीएसटी उपकर कर क्रेडिट
100%	NA

#### Consignees/Reporting Officer/परेषिती/रिपोर्टिंग अधिकारी and/ तथा Quantity/मात्रा

S.No./क्र. सं.	Consignee Reporting/Officer/ परेषिती/रिपोर्टिंग अधिकारी	Address/पता	Quantity/मात्रा	Delivery Days/डिलीवरी के दिन
1	*****	*****Mumbai	16000	45

#### Item No 16 Material Code 18701998

(Minimum 50% and 20% Local Content required for qualifying as Class 1 and Class 2 Local Supplier respectively/क्रमशः श्रेणी 1 और श्रेणी 2 के स्थानीय आपूर्तिकर्ता के रूप में अर्हता प्राप्त करने के लिए आवश्यक)

#### Technical Specifications/तकनीकी विशिष्टियाँ

Specification Document	<a href="#">View File</a>
BOQ Detail Document	<a href="#">View File</a>

Advisory-Please refer attached BOQ document for detailed consignee list and delivery period.

**Input Tax Credit(ITC)/इनपुट कर क्रेडिट(आईटीसी) and/ तथा Reverse Charge(RCM)/रिवर्स प्रभार (आरसीएम) Details**

ITC on GST/जीएसटी पर इनपुट कर क्रेडिट	ITC on GST Cess/जीएसटी उपकर कर क्रेडिट
100%	NA

**Consignees/Reporting Officer/परेषिती/रिपोर्टिंग अधिकारी and/ तथा Quantity/मात्रा**

S.No./क्र. सं.	Consignee Reporting/Officer/ परेषिती/रिपोर्टिंग अधिकारी	Address/पता	Quantity/मात्रा	Delivery Days/डिलीवरी के दिन
1	*****	*****Mumbai	16000	45

**Item No 17 Material Code18701999**

**(Minimum 50% and 20% Local Content required for qualifying as Class 1 and Class 2 Local Supplier respectively/क्रमशः श्रेणी 1 और श्रेणी 2 के स्थानीय आपूर्तिकर्ता के रूप में अर्हता प्राप्त करने के लिए आवश्यक)**

**Technical Specifications/तकनीकी विशिष्टियाँ**

Specification Document	<a href="#">View File</a>
BOQ Detail Document	<a href="#">View File</a>

Advisory-Please refer attached BOQ document for detailed consignee list and delivery period.

**Input Tax Credit(ITC)/इनपुट कर क्रेडिट(आईटीसी) and/ तथा Reverse Charge(RCM)/रिवर्स प्रभार (आरसीएम) Details**

ITC on GST/जीएसटी पर इनपुट कर क्रेडिट	ITC on GST Cess/जीएसटी उपकर कर क्रेडिट
100%	NA

**Consignees/Reporting Officer/परेषिती/रिपोर्टिंग अधिकारी and/ तथा Quantity/मात्र**

S.No./क्र. सं.	Consignee Reporting/Officer/ परेषिती/रिपोर्टिंग अधिकारी	Address/पता	Quantity/मात्र	Delivery Days/डिलीवरी के दिन
1	*****	*****Mumbai	16000	45

**Item No 18 Material Code 18701589**

(Minimum 50% and 20% Local Content required for qualifying as Class 1 and Class 2 Local Supplier respectively/क्रमशः श्रेणी 1 और श्रेणी 2 के स्थानीय आपूर्तिकर्ता के रूप में अर्हता प्राप्त करने के लिए आवश्यक)

**Technical Specifications/तकनीकी विशिष्टियाँ**

Specification Document	<a href="#">View File</a>
BOQ Detail Document	<a href="#">View File</a>

Advisory-Please refer attached BOQ document for detailed consignee list and delivery period.

**Input Tax Credit(ITC)/इनपुट कर क्रेडिट(आईटीसी) and/ तथा Reverse Charge(RCM)/रिवर्स प्रभार (आरसीएम) Details**

ITC on GST/जीएसटी पर इनपुट कर क्रेडिट	ITC on GST Cess/जीएसटी उपकर कर क्रेडिट
100%	NA

**Consignees/Reporting Officer/परेषिती/रिपोर्टिंग अधिकारी and/ तथा Quantity/मात्र**

S.No./क्र. सं.	Consignee Reporting/Officer/ परेषिती/रिपोर्टिंग अधिकारी	Address/पता	Quantity/मात्र	Delivery Days/डिलीवरी के दिन
1	*****	*****Mumbai	42000	45

**Item No 19 Material Code 18703225**

(Minimum 50% and 20% Local Content required for qualifying as Class 1 and Class 2 Local Supplier respectively/क्रमशः श्रेणी 1 और श्रेणी 2 के स्थानीय आपूर्तिकर्ता के रूप में अर्हता प्राप्त करने के लिए आवश्यक)

**Technical Specifications/तकनीकी विशिष्टियाँ**

<b>Specification Document</b>	<a href="#">View File</a>
<b>BOQ Detail Document</b>	<a href="#">View File</a>

Advisory-Please refer attached BOQ document for detailed consignee list and delivery period.

**Input Tax Credit(ITC)/इनपुट कर क्रेडिट(आईटीसी) and/ तथा Reverse Charge(RCM)/रिवर्स प्रभार (आरसीएम) Details**

<b>ITC on GST/जीएसटी पर इनपुट कर क्रेडिट</b>	<b>ITC on GST Cess/जीएसटी उपकर कर क्रेडिट</b>
100%	NA

**Consignees/Reporting Officer/परेषिती/रिपोर्टिंग अधिकारी and/ तथा Quantity/मात्रा**

<b>S.No./क्र. सं.</b>	<b>Consignee Reporting/Officer/ परेषिती/रिपोर्टिंग अधिकारी</b>	<b>Address/पता</b>	<b>Quantity/मात्रा</b>	<b>Delivery Days/डिलीवरी के दिन</b>
1	*****	*****Mumbai	1470000	45

**Item No 20 Material Code 18703226**

**(Minimum 50% and 20% Local Content required for qualifying as Class 1 and Class 2 Local Supplier respectively/क्रमशः श्रेणी 1 और श्रेणी 2 के स्थानीय आपूर्तिकर्ता के रूप में अर्हता प्राप्त करने के लिए आवश्यक)**

**Technical Specifications/तकनीकी विशिष्टियाँ**

<b>Specification Document</b>	<a href="#">View File</a>
<b>BOQ Detail Document</b>	<a href="#">View File</a>

Advisory-Please refer attached BOQ document for detailed consignee list and delivery period.

**Input Tax Credit(ITC)/इनपुट कर क्रेडिट(आईटीसी) and/ तथा Reverse Charge(RCM)/रिवर्स प्रभार (आरसीएम) Details**

<b>ITC on GST/जीएसटी पर इनपुट कर क्रेडिट</b>	<b>ITC on GST Cess/जीएसटी उपकर कर क्रेडिट</b>
100%	NA

**Consignees/Reporting Officer/परेषिती/रिपोर्टिंग अधिकारी and/ तथा Quantity/मात्रा**

<b>S.No./क्र. सं.</b>	<b>Consignee Reporting/Officer/ परेषिती/रिपोर्टिंग अधिकारी</b>	<b>Address/पता</b>	<b>Quantity/मात्रा</b>	<b>Delivery Days/डिलीवरी के दिन</b>
1	*****	*****Mumbai	262500	45

**Item No 21 Material Code 18703227**

**(Minimum 50% and 20% Local Content required for qualifying as Class 1 and Class 2 Local Supplier respectively/क्रमशः श्रेणी 1 और श्रेणी 2 के स्थानीय आपूर्तिकर्ता के रूप में अर्हता प्राप्त करने के लिए आवश्यक)**

**Technical Specifications/तकनीकी विशिष्टियाँ**

<b>Specification Document</b>	<a href="#">View File</a>
<b>BOQ Detail Document</b>	<a href="#">View File</a>

Advisory-Please refer attached BOQ document for detailed consignee list and delivery period.

**Input Tax Credit(ITC)/इनपुट कर क्रेडिट(आईटीसी) and/ तथा Reverse Charge(RCM)/रिवर्स प्रभार (आरसीएम) Details**

<b>ITC on GST/जीएसटी पर इनपुट कर क्रेडिट</b>	<b>ITC on GST Cess/जीएसटी उपकर कर क्रेडिट</b>
100%	NA

**Consignees/Reporting Officer/परेषिती/रिपोर्टिंग अधिकारी and/ तथा Quantity/मात्रा**

<b>S.No./क्र. सं.</b>	<b>Consignee Reporting/Officer/ परेषिती/रिपोर्टिंग अधिकारी</b>	<b>Address/पता</b>	<b>Quantity/मात्रा</b>	<b>Delivery Days/डिलीवरी के दिन</b>
1	*****	*****Mumbai	36800	45

**Item No 22 Material Code 18703228**

**(Minimum 50% and 20% Local Content required for qualifying as Class 1 and Class 2 Local Supplier respectively/क्रमशः श्रेणी 1 और श्रेणी 2 के स्थानीय आपूर्तिकर्ता के रूप में अर्हता प्राप्त करने के लिए आवश्यक)**

**Technical Specifications/तकनीकी विशिष्टियाँ**

<b>Specification Document</b>	<a href="#">View File</a>
<b>BOQ Detail Document</b>	<a href="#">View File</a>

Advisory-Please refer attached BOQ document for detailed consignee list and delivery period.

**Input Tax Credit(ITC)/इनपुट कर क्रेडिट(आईटीसी) and/ तथा Reverse Charge(RCM)/रिवर्स प्रभार (आरसीएम) Details**

<b>ITC on GST/जीएसटी पर इनपुट कर क्रेडिट</b>	<b>ITC on GST Cess/जीएसटी उपकर कर क्रेडिट</b>
100%	NA

**Consignees/Reporting Officer/परेषिती/रिपोर्टिंग अधिकारी and/ तथा Quantity/मात्रा**

<b>S.No./क्र. सं.</b>	<b>Consignee Reporting/Officer/ परेषिती/रिपोर्टिंग अधिकारी</b>	<b>Address/पता</b>	<b>Quantity/मात्रा</b>	<b>Delivery Days/डिलीवरी के दिन</b>
1	*****	*****Mumbai	73500	45

**Item No 23 Material Code 18703229**

**(Minimum 50% and 20% Local Content required for qualifying as Class 1 and Class 2 Local Supplier respectively/क्रमशः श्रेणी 1 और श्रेणी 2 के स्थानीय आपूर्तिकर्ता के रूप में अर्हता प्राप्त करने के लिए आवश्यक)**

**Technical Specifications/तकनीकी विशिष्टियाँ**

<b>Specification Document</b>	<a href="#">View File</a>
<b>BOQ Detail Document</b>	<a href="#">View File</a>

Advisory-Please refer attached BOQ document for detailed consignee list and delivery period.

**Input Tax Credit(ITC)/इनपुट कर क्रेडिट(आईटीसी) and/ तथा Reverse Charge(RCM)/रिवर्स प्रभार (आरसीएम) Details**

ITC on GST/जीएसटी पर इनपुट कर क्रेडिट	ITC on GST Cess/जीएसटी उपकर कर क्रेडिट
100%	NA

**Consignees/Reporting Officer/परेषिती/रिपोर्टिंग अधिकारी and/ तथा Quantity/मात्रा**

S.No./क्र. सं.	Consignee Reporting/Officer/ परेषिती/रिपोर्टिंग अधिकारी	Address/पता	Quantity/मात्रा	Delivery Days/डिलीवरी के दिन
1	*****	*****Mumbai	1470000	45

**Item No 24 Material Code 18703230**

(Minimum 50% and 20% Local Content required for qualifying as Class 1 and Class 2 Local Supplier respectively/क्रमशः श्रेणी 1 और श्रेणी 2 के स्थानीय आपूर्तिकर्ता के रूप में अर्हता प्राप्त करने के लिए आवश्यक)

**Technical Specifications/तकनीकी विशिष्टियाँ**

Specification Document	<a href="#">View File</a>
BOQ Detail Document	<a href="#">View File</a>

Advisory-Please refer attached BOQ document for detailed consignee list and delivery period.

**Input Tax Credit(ITC)/इनपुट कर क्रेडिट(आईटीसी) and/ तथा Reverse Charge(RCM)/रिवर्स प्रभार (आरसीएम) Details**

ITC on GST/जीएसटी पर इनपुट कर क्रेडिट	ITC on GST Cess/जीएसटी उपकर कर क्रेडिट
100%	NA

**Consignees/Reporting Officer/परेषिती/रिपोर्टिंग अधिकारी and/ तथा Quantity/मात्रा**

S.No./क्र. सं.	Consignee Reporting/Officer/ परेषिती/रिपोर्टिंग अधिकारी	Address/पता	Quantity/मात्रा	Delivery Days/डिलीवरी के दिन
1	*****	*****Mumbai	262500	45

**Item No 25 Material Code 18703231**

(Minimum 50% and 20% Local Content required for qualifying as Class 1 and Class 2 Local Supplier respectively/क्रमशः श्रेणी 1 और श्रेणी 2 के स्थानीय आपूर्तिकर्ता के रूप में अर्हता प्राप्त करने के लिए आवश्यक)

**Technical Specifications/तकनीकी विशिष्टियाँ**

<b>Specification Document</b>	<a href="#">View File</a>
<b>BOQ Detail Document</b>	<a href="#">View File</a>

Advisory-Please refer attached BOQ document for detailed consignee list and delivery period.

**Input Tax Credit(ITC)/इनपुट कर क्रेडिट(आईटीसी) and/ तथा Reverse Charge(RCM)/रिवर्स प्रभार (आरसीएम) Details**

<b>ITC on GST/जीएसटी पर इनपुट कर क्रेडिट</b>	<b>ITC on GST Cess/जीएसटी उपकर कर क्रेडिट</b>
100%	NA

**Consignees/Reporting Officer/परेषिती/रिपोर्टिंग अधिकारी and/ तथा Quantity/मात्रा**

<b>S.No./क्र. सं.</b>	<b>Consignee Reporting/Officer/ परेषिती/रिपोर्टिंग अधिकारी</b>	<b>Address/पता</b>	<b>Quantity/मात्रा</b>	<b>Delivery Days/डिलीवरी के दिन</b>
1	*****	*****Mumbai	36800	45

**Item No 26 Material Code 18701962**

(Minimum 50% and 20% Local Content required for qualifying as Class 1 and Class 2 Local Supplier respectively/क्रमशः श्रेणी 1 और श्रेणी 2 के स्थानीय आपूर्तिकर्ता के रूप में अर्हता प्राप्त करने के लिए आवश्यक)

**Technical Specifications/तकनीकी विशिष्टियाँ**

<b>Specification Document</b>	<a href="#">View File</a>
<b>BOQ Detail Document</b>	<a href="#">View File</a>

Advisory-Please refer attached BOQ document for detailed consignee list and delivery period.

**Input Tax Credit(ITC)/इनपुट कर क्रेडिट(आईटीसी) and/ तथा Reverse Charge(RCM)/रिवर्स प्रभार (आरसीएम) Details**

ITC on GST/जीएसटी पर इनपुट कर क्रेडिट	ITC on GST Cess/जीएसटी उपकर कर क्रेडिट
100%	NA

**Consignees/Reporting Officer/परेषिती/रिपोर्टिंग अधिकारी and/ तथा Quantity/मात्रा**

S.No./क्र. सं.	Consignee Reporting/Officer/ परेषिती/रिपोर्टिंग अधिकारी	Address/पता	Quantity/मात्रा	Delivery Days/डिलीवरी के दिन
1	*****	*****Mumbai	560000	45

**Item No 27 Material Code 18701578**

(Minimum 50% and 20% Local Content required for qualifying as Class 1 and Class 2 Local Supplier respectively/क्रमशः श्रेणी 1 और श्रेणी 2 के स्थानीय आपूर्तिकर्ता के रूप में अर्हता प्राप्त करने के लिए आवश्यक)

**Technical Specifications/तकनीकी विशिष्टियाँ**

Specification Document	<a href="#">View File</a>
BOQ Detail Document	<a href="#">View File</a>

Advisory-Please refer attached BOQ document for detailed consignee list and delivery period.

**Input Tax Credit(ITC)/इनपुट कर क्रेडिट(आईटीसी) and/ तथा Reverse Charge(RCM)/रिवर्स प्रभार (आरसीएम) Details**

ITC on GST/जीएसटी पर इनपुट कर क्रेडिट	ITC on GST Cess/जीएसटी उपकर कर क्रेडिट
100%	NA

**Consignees/Reporting Officer/परेषिती/रिपोर्टिंग अधिकारी and/ तथा Quantity/मात्रा**

S.No./क्र. सं.	Consignee Reporting/Officer/ परेषिती/रिपोर्टिंग अधिकारी	Address/पता	Quantity/मात्रा	Delivery Days/डिलीवरी के दिन
1	*****	*****Mumbai	160000	45

### Item No 28 Material Code 18703111

(Minimum 50% and 20% Local Content required for qualifying as Class 1 and Class 2 Local Supplier respectively/क्रमशः श्रेणी 1 और श्रेणी 2 के स्थानीय आपूर्तिकर्ता के रूप में अर्हता प्राप्त करने के लिए आवश्यक)

#### Technical Specifications/तकनीकी विशिष्टियाँ

Specification Document	<a href="#">View File</a>
BOQ Detail Document	<a href="#">View File</a>

Advisory-Please refer attached BOQ document for detailed consignee list and delivery period.

#### Input Tax Credit(ITC)/इनपुट कर क्रेडिट(आईटीसी) and/ तथा Reverse Charge(RCM)/रिवर्स प्रभार (आरसीएम) Details

ITC on GST/जीएसटी पर इनपुट कर क्रेडिट	ITC on GST Cess/जीएसटी उपकर कर क्रेडिट
100%	NA

#### Consignees/Reporting Officer/परेषिती/रिपोर्टिंग अधिकारी and/ तथा Quantity/मात्रा

S.No./क्र. सं.	Consignee Reporting/Officer/ परेषिती/रिपोर्टिंग अधिकारी	Address/पता	Quantity/मात्रा	Delivery Days/डिलीवरी के दिन
1	*****	*****Mumbai	160000	45

### Item No 29 Material Code 18703221

(Minimum 50% and 20% Local Content required for qualifying as Class 1 and Class 2 Local Supplier respectively/क्रमशः श्रेणी 1 और श्रेणी 2 के स्थानीय आपूर्तिकर्ता के रूप में अर्हता प्राप्त करने के लिए आवश्यक)

#### Technical Specifications/तकनीकी विशिष्टियाँ

Specification Document	<a href="#">View File</a>
BOQ Detail Document	<a href="#">View File</a>

Advisory-Please refer attached BOQ document for detailed consignee list and delivery period.

**Input Tax Credit(ITC)/इनपुट कर क्रेडिट(आईटीसी) and/ तथा Reverse Charge(RCM)/रिवर्स प्रभार (आरसीएम) Details**

ITC on GST/जीएसटी पर इनपुट कर क्रेडिट	ITC on GST Cess/जीएसटी उपकर कर क्रेडिट
100%	NA

**Consignees/Reporting Officer/परेषिती/रिपोर्टिंग अधिकारी and/ तथा Quantity/मात्रा**

S.No./क्र. सं.	Consignee Reporting/Officer/ परेषिती/रिपोर्टिंग अधिकारी	Address/पता	Quantity/मात्रा	Delivery Days/डिलीवरी के दिन
1	*****	*****Mumbai	160000	45

**Item No 30 Material Code 18707426**

**(Minimum 50% and 20% Local Content required for qualifying as Class 1 and Class 2 Local Supplier respectively/क्रमशः श्रेणी 1 और श्रेणी 2 के स्थानीय आपूर्तिकर्ता के रूप में अर्हता प्राप्त करने के लिए आवश्यक)**

**Technical Specifications/तकनीकी विशिष्टियाँ**

Specification Document	<a href="#">View File</a>
BOQ Detail Document	<a href="#">View File</a>

Advisory-Please refer attached BOQ document for detailed consignee list and delivery period.

**Input Tax Credit(ITC)/इनपुट कर क्रेडिट(आईटीसी) and/ तथा Reverse Charge(RCM)/रिवर्स प्रभार (आरसीएम) Details**

ITC on GST/जीएसटी पर इनपुट कर क्रेडिट	ITC on GST Cess/जीएसटी उपकर कर क्रेडिट
100%	NA

**Consignees/Reporting Officer/परेषिती/रिपोर्टिंग अधिकारी and/ तथा Quantity/मात्र**

S.No./क्र. सं.	Consignee Reporting/Officer/ परेषिती/रिपोर्टिंग अधिकारी	Address/पता	Quantity/मात्र	Delivery Days/डिलीवरी के दिन
1	*****	*****Mumbai	100000	45

**Item No 31 Material Code 18703041**

(Minimum 50% and 20% Local Content required for qualifying as Class 1 and Class 2 Local Supplier respectively/क्रमशः श्रेणी 1 और श्रेणी 2 के स्थानीय आपूर्तिकर्ता के रूप में अर्हता प्राप्त करने के लिए आवश्यक)

**Technical Specifications/तकनीकी विशिष्टियाँ**

Specification Document	<a href="#">View File</a>
BOQ Detail Document	<a href="#">View File</a>

Advisory-Please refer attached BOQ document for detailed consignee list and delivery period.

**Input Tax Credit(ITC)/इनपुट कर क्रेडिट(आईटीसी) and/ तथा Reverse Charge(RCM)/रिवर्स प्रभार (आरसीएम) Details**

ITC on GST/जीएसटी पर इनपुट कर क्रेडिट	ITC on GST Cess/जीएसटी उपकर कर क्रेडिट
100%	NA

**Consignees/Reporting Officer/परेषिती/रिपोर्टिंग अधिकारी and/ तथा Quantity/मात्र**

S.No./क्र. सं.	Consignee Reporting/Officer/ परेषिती/रिपोर्टिंग अधिकारी	Address/पता	Quantity/मात्र	Delivery Days/डिलीवरी के दिन
1	*****	*****Mumbai	280000	45

**Item No 32 Material Code 18701576**

(Minimum 50% and 20% Local Content required for qualifying as Class 1 and Class 2 Local Supplier respectively/क्रमशः श्रेणी 1 और श्रेणी 2 के स्थानीय आपूर्तिकर्ता के रूप में अर्हता प्राप्त करने के लिए आवश्यक)

**Technical Specifications/तकनीकी विशिष्टियाँ**

<b>Specification Document</b>	<a href="#">View File</a>
<b>BOQ Detail Document</b>	<a href="#">View File</a>

Advisory-Please refer attached BOQ document for detailed consignee list and delivery period.

**Input Tax Credit(ITC)/इनपुट कर क्रेडिट(आईटीसी) and/ तथा Reverse Charge(RCM)/रिवर्स प्रभार (आरसीएम) Details**

<b>ITC on GST/जीएसटी पर इनपुट कर क्रेडिट</b>	<b>ITC on GST Cess/जीएसटी उपकर कर क्रेडिट</b>
100%	NA

**Consignees/Reporting Officer/परेषिती/रिपोर्टिंग अधिकारी and/ तथा Quantity/मात्रा**

<b>S.No./क्र. सं.</b>	<b>Consignee Reporting/Officer/ परेषिती/रिपोर्टिंग अधिकारी</b>	<b>Address/पता</b>	<b>Quantity/मात्रा</b>	<b>Delivery Days/डिलीवरी के दिन</b>
1	*****	*****Mumbai	280000	45

**Item No 33 Material Code 18703211**

**(Minimum 50% and 20% Local Content required for qualifying as Class 1 and Class 2 Local Supplier respectively/क्रमशः श्रेणी 1 और श्रेणी 2 के स्थानीय आपूर्तिकर्ता के रूप में अर्हता प्राप्त करने के लिए आवश्यक)**

**Technical Specifications/तकनीकी विशिष्टियाँ**

<b>Specification Document</b>	<a href="#">View File</a>
<b>BOQ Detail Document</b>	<a href="#">View File</a>

Advisory-Please refer attached BOQ document for detailed consignee list and delivery period.

**Input Tax Credit(ITC)/इनपुट कर क्रेडिट(आईटीसी) and/ तथा Reverse Charge(RCM)/रिवर्स प्रभार (आरसीएम) Details**

<b>ITC on GST/जीएसटी पर इनपुट कर क्रेडिट</b>	<b>ITC on GST Cess/जीएसटी उपकर कर क्रेडिट</b>
100%	NA

**Consignees/Reporting Officer/परेषिती/रिपोर्टिंग अधिकारी and/ तथा Quantity/मात्रा**

<b>S.No./क्र. सं.</b>	<b>Consignee Reporting/Officer/ परेषिती/रिपोर्टिंग अधिकारी</b>	<b>Address/पता</b>	<b>Quantity/मात्रा</b>	<b>Delivery Days/डिलीवरी के दिन</b>
1	*****	*****Mumbai	100000	45

**Buyer Added Bid Specific Terms and Conditions/क्रेता द्वारा जोड़ी गई बिड की विशेष शर्तें**

**1. Generic**

Bidder shall submit the following documents along with their bid for Vendor Code Creation:

- Copy of PAN Card.
- Copy of GSTIN.
- Copy of Cancelled Cheque.
- Copy of EFT Mandate duly certified by Bank.

**2. Certificates**

Bidder's offer is liable to be rejected if they don't upload any of the certificates / documents sought in the Bid document, ATC and Corrigendum if any.

**3. Generic**

OPTION CLAUSE: The Purchaser reserves the right to increase or decrease the quantity to be ordered up to 50 percent of bid quantity at the time of placement of contract. The purchaser also reserves the right to increase the ordered quantity by up to 50% of the contracted quantity during the currency of the contract at the contracted rates. Bidders are bound to accept the orders accordingly.

**4. Generic**

Supplier shall ensure that the Invoice is raised in the name of Consignee with GSTIN of Consignee only.

**5. Scope of Supply**

Scope of supply (Bid price to include all cost components) : Only supply of Goods

**6. Buyer Added Bid Specific ATC**

Buyer Added text based ATC clauses

**A. Forms of EMD and PBG:**

Bidders can also submit the EMD with Payment online through RTGS / internet banking in Beneficiary name : Mazagon Dock Shipbuilders Limited. Account No: 10005255246 IFSC Code :SBIN0009054 Bank Name: Sta

te Bank of India Address Mazagon Branch, Mazagon, Mumbai - 400010 . Bidder to indicate bid number and name of bidding entity in the transaction details field at the time of online transfer. Bidder has to upload scanned copy / proof of the Online Payment Transfer along with bid.

#### **B: Forms of EMD and PBG**

Successful Bidder can submit the Performance Security in the form of Payment online through RTGS / internet banking also (besides PBG which is allowed as per GeM GTC). Online payment shall be in Beneficiary name: Mazagon Dock Shipbuilders Limited Account No: 10005255246 IFSC Code: SBIN0009054 Bank Name : State Bank Of India Branch address: Mazagon Branch Mazagon, Mumbai - 4 000 10 . Successful Bidder to indicate Contract number . Successful Bidder to indicate Contract number and name of Seller entity in the transaction details field at the time of on-line transfer. Bidder has to upload scanned copy / proof of the Online Payment Transfer in place of PBG within 15 days of award of contract.

#### **C. Generic:**

1. The Seller shall not assign the Contract in whole or part without obtaining the prior written consent of buyer. 2. The Seller shall not sub-contract the Contract in whole or part to any entity without obtaining the prior written consent of buyer. 3. The Seller shall, notwithstanding the consent and assignment/ sub-contract , remain jointly and severally liable and responsible to buyer together with the assignee/ sub-contractor, for and in respect of the due performance of the Contract and the Sellers obligations there under.

#### **D. Generic**

Without prejudice to Buyer's right to price adjustment by way of discount or any other right or remedy available to Buyer, Buyer may terminate the Contract or any part thereof by a written notice to the Seller, if:

- i) The Seller fails to comply with any material term of the Contract.
- ii) The Seller informs Buyer of its inability to deliver the Material(s) or any part thereof within the stipulated Delivery Period or such inability otherwise becomes apparent.
- iii) The Seller fails to deliver the Material(s) or any part thereof within the stipulated Delivery Period and/or to replace/rectify any rejected or defective Material(s) promptly. i
- v) The Seller becomes bankrupt or goes into liquidation.
- v) The Seller makes a general assignment for the benefit of creditors. vi) A receiver is appointed for any substantial property owned by the Seller.
- vii) The Seller has misrepresented to Buyer, acting on which misrepresentation Buyer has placed the Purchase Order on the Seller.

#### **7. Buyer Added Bid Specific ATC**

Buyer uploaded ATC document [Click here to view the file.](#)

### **Disclaimer/अस्वीकरण**

The additional terms and conditions have been incorporated by the Buyer after approval of the Competent Authority in Buyer Organization, whereby Buyer organization is solely responsible for the impact of these clauses on the bidding process, its outcome, and consequences thereof including any eccentricity / restriction arising in the bidding process due to these ATCs and due to modification of technical specifications and / or terms and conditions governing the bid. If any clause(s) is / are incorporated by the Buyer regarding following, the bid and resultant contracts shall be treated as null and void and such bids may be cancelled by GeM at any stage of bidding process without any notice:-

1. Definition of Class I and Class II suppliers in the bid not in line with the extant Order / Office Memorandum issued by DPIIT in this regard.
2. Seeking EMD submission from bidder(s), including via Additional Terms & Conditions, in contravention to exemption provided to such sellers under GeM GTC.
3. Publishing Custom / BOQ bids for items for which regular GeM categories are available without any

Category item bunched with it.

4. Creating BoQ bid for single item.
5. Mentioning specific Brand or Make or Model or Manufacturer or Dealer name.
6. Mandating submission of documents in physical form as a pre-requisite to qualify bidders.
7. Floating / creation of work contracts as Custom Bids in Services.
8. Seeking sample with bid or approval of samples during bid evaluation process. (However, in bids for [attached categories](#), trials are allowed as per approved procurement policy of the buyer nodal Ministries)
9. Mandating foreign / international certifications even in case of existence of Indian Standards without specifying equivalent Indian Certification / standards.
10. Seeking experience from specific organization / department / institute only or from foreign / export experience.
11. Creating bid for items from irrelevant categories.
12. Incorporating any clause against the MSME policy and Preference to Make in India Policy.
13. Reference of conditions published on any external site or reference to external documents/clauses.
14. Asking for any Tender fee / Bid Participation fee / Auction fee in case of Bids / Forward Auction, as the case may be.

Further, if any seller has any objection/grievance against these additional clauses or otherwise on any aspect of this bid, they can raise their representation against the same by using the Representation window provided in the bid details field in Seller dashboard after logging in as a seller within 4 days of bid publication on GeM. Buyer is duty bound to reply to all such representations and would not be allowed to open bids if he fails to reply to such representations.

[This Bid is also governed by the General Terms and Conditions/ यह बिड सामान्य शर्तों के अंतर्गत भी शासित है](#)

In terms of GeM GTC clause 26 regarding Restrictions on procurement from a bidder of a country which shares a land border with India, any bidder from a country which shares a land border with India will be eligible to bid in this tender only if the bidder is registered with the Competent Authority. While participating in bid, Bidder has to undertake compliance of this and any false declaration and non-compliance of this would be a ground for immediate termination of the contract and further legal action in accordance with the laws./जेम की सामान्य शर्तों के खंड 26 के संदर्भ में भारत के साथ भूमि सीमा साझा करने वाले देश के बिडर से खरीद पर प्रतिबंध के संबंध में भारत के साथ भूमि सीमा साझा करने वाले देश का कोई भी बिडर इस निविदा में बिड देने के लिए तभी पात्र होगा जब वह बिड देने वाला सक्षम प्राधिकारी के पास पंजीकृत हो। बिड में भाग लेते समय बिडर को इसका अनुपालन करना होगा और कोई भी गलत घोषणा किए जाने व इसका अनुपालन न करने पर अनुबंध को तत्काल समाप्त करने और कानून के अनुसार आगे की कानूनी कार्रवाई का आधार होगा।

**---Thank You/धन्यवाद---**



**Only MSE manufacturing for the tendered items are eligible to bid in this tender.**

**Procurement of MS Bolt, Nut, Screw, Washer (Cad Plated, Zinc Plated, Hot Dip / Electro Galvanised)**

**Additional Terms & Conditions (ATC)**

**GeM Tender GEM/2024/B/5278726**

1. **Drawing for tender** item no 08 (material code no. 18701961) & item no 30 (material code no. 18707426) are attached as enclosure 5 & enclosure 6 respectively.
2. **Integrity Pact (IP):** The Integrity pact essentially envisages the agreement between prospective vendors / bidders & buyers committing the person/officials of both the parties not to exercise any corrupt influence on any aspects of the contract. Only those vendors/bidders who enter into such an integrity pact with the buyer would be competent to participate in the bid. Therefore, non-acceptance and non-submission of IP by the vendors/bidders along with offer shall be liable for rejection and no further communication in this regard will be entertained by MDL. The format of integrity Pact is enclosed with tender documents. The IP shall be uploaded on plain paper.

The 'Integrity pact' dully filled as per enclosed format to be uploaded along with the offer. Bidders to ensure that each page of Integrity pact shall be duly signed by the bidder. Non-submission of Integrity Pact by the bidders duly filled and signed on each page along with Part-I bid shall be liable for rejection. Bidders shall send original IP within 7 days to MDL post submission of bid;

GM(Material)  
GeM Tender GEM/2024/B/5278726  
kind attention: Mr. Nikesh Parate CM(C-MP)

Mazagon Dock Shipbuilders Ltd.  
Dockyard Road, Mumbai 400010.  
Maharashtra.

3. **Performance Bank Guarantee:**
  - A. In continuation to GeM bid clause no (c) In case bidder opts to submit hard copy of the Performance Bank Guarantee(PBG) then Hard original copy of the PBG is required to be sent by the issuing bank directly to MDL through Registered AD, super scribing the envelope with Tender / GeM order number addressed to General Manager (Material Purchase) and in kind attention of Dealing commercial executive. Details of the concerned dealing commercial executive have been provided at clause 20.
  - B. In cases where the supplier / contractor has not submitted the Performance Bank Guarantee and already commenced supply / services, amount equivalent to the Performance security shall be withhold from supplier's bills. In such case, interest amount shall be recovered for the period starting from 16th day of transmission / notification of order/contract by any mode, at the relevant rate of interest i.e. SBI BPLR plus 2%.
4. **Public Procurement Policy (Preference to Make in India) Order 2017: Minimum local content:**
  - A. Nodal Ministry (Ministry of Steel) has notified an exclusive list for Domestically manufactured products wherein Minimum Local Content requirement is mentioned as 20%  
The minimum local content requirement is 20% as per Ministry of Steel Notification No. S-13026/1/2020-IDD dated 31 December 2020, Revised Appendix A Sl. No. 38.



## Mazagon Dock Shipbuilders Limited, Mumbai

**B.** Once the Local Content declaration / certification is committed at tender submission stage, the same cannot be altered subsequently at technical negotiation stage or after award of contract. Doing so would be treated / considered as false declaration by bidder and necessary action shall be initiated including debarment as deemed fit

### 5. Earnest Money Deposit (EMD) / Bid Security:

- a) Following categories of Sellers shall be exempted from furnishing Bid Security/EMD:
  - i) Micro and Small Enterprises (MSEs) who are holding valid Udyam Registration and are manufacturer of the **offered** Product or Service (Primary Product / Service - in case of bunch bid with total value wise evaluation) and give specific confirmation to this effect at the time of bid submission and claim EMD exemption and whose credentials are validated online through Udyam Registration website of Ministry of MSME and also through supporting document uploaded during bidding process and validated by the Buyer.
  - ii) Start-ups as recognized by Department for Promotion of Industry and Internal Trade (DPIIT), holding valid Startup Recognition Certificate which is to be uploaded while bidding and claiming EMD exemption and to be validated by the Buyer. Bidder to ensure that turnover for any of the financial years has not exceeded beyond limits prescribed in the certificate / Start Up scheme of DPIIT.
  - iii) KVIC, ACASH, WDO, Coir Board, TRIFED and Kendriya Bhandar.
  - iv) Sellers who have got their credentials verified through the process of Vendor Assessment by Vendor Assessment Agencies for the Primary Product / Primary Service for which Bid / RA has been invited and holding valid Vendor Assessment or Vendor Assessment Exemption Report / confirmation (Seller to upload VA report / VAE confirmation to be validated by the Buyer).
  - v) Sellers / Service Provider having annual turnover of INR 500 Crore or more, at least in one of the past three completed financial year(s)
  - vi) Sellers / Service Providers holding valid BIS License for the Primary Product Category whose credentials are validated through BIS database and through uploaded supporting documents to be validated by the buyer.
  - vii) Central / State PSUs
  - viii) Bidders registered (Permanent-MDLP) with Mazagon Dock Shipbuilders Limited (MDL) for the **MDL Material Group – 8700 & F003003 (Eligible for EMD exemption for tender item sr. no. 1, 2, 3, 9 to 18), MDL Material Group – 8701 (Eligible for EMD exemption for tender item sr. no. 4, 5, 6, 8, 26, 27, 32), MDL Material Group – 8703 (Eligible for EMD exemption for tender item sr. no. 7, 28, 29, 31, 33), 1008703 (Eligible for EMD exemption for tender item sr. no. 19 to 25, 28, 29, 31, 33), 1008707 & 8707 (Eligible for EMD exemption for tender item sr. no. 30)** are exempted from submission of EMD. However, to qualify for EMD exemption, bidders should necessarily upload copy of valid registration certificate issued by MDL in Part-I offer/bid. Bidders in process of obtaining MDL registration will not be considered for EMD exemption.
  - ix) Common/Deemed DPSU registered vendors qualify for EMD exemption. Such firms shall submit valid copy of the registration certificate issued by DPSUs (other than MDL) for the items / services for which the offer is being submitted in Part-I offer/bid. Firms in process of obtaining registration in other DPSUs will not be considered for EMD exemption
  - x) Green Channel Status vendors qualify for EMD exemption. Such firms shall submit valid copy of the Green channel certificate issued by MoD for the items for which the offer is being submitted in Part-I offer/bid. Firms in process of obtaining this certificate will not be considered for EMD exemption.
- b) The bidder seeking EMD exemption, must submit the valid supporting document with the bid.
- c) Under MSE category, only manufacturers for goods and Service Providers for Services are eligible for exemption from EMD. **Traders are excluded from the purview of this Policy.**



## Mazagon Dock Shipbuilders Limited, Mumbai

### 6. Bid Rejection Criteria:

#### Liabile rejection criteria:

- (i) Non-compliance/non-acceptance to any of the terms and conditions of the tender other than clause mentioned under loading criteria shall render the bid liable for rejection:
- (ii) Bidders are required to submit the shortfall documents / clarifications within the duration / date stipulated by MDL failing which their bids will be liable for rejection.
- (iii) Bids of 'non-Class I' or 'non- Class –II (i.e. who do not meet the requirement of minimum local content) local suppliers' are liable for rejection.

### 7. Pricing:

- i) Bidders shall quote for delivery of the items to the following destination including charges towards inland transportation, insurance, unloading charges and other local costs incidental to the delivery of the Goods/Services.
- ii) Delivery Address: Mazagon Dock Shipbuilders Limited, Dockyard Road, Mumbai -400010.
- iii) Wherever all-inclusive prices are quoted by the Tenderer(s) without bifurcation of tax elements, no escalation can be considered in respect of any variations in statutory levies arising subsequently because of the absence of the required base figures in the purchase order / contract.

### 8. Alternate MSME vendor payment through TReDS:

- i) In order to address the financial needs of MSME firms, Govt has introduced a platform for facilitating the financing of trade receivables of MSMEs from buyers, through multiple financiers which is termed as Trade Receivables Discounting System (TReDS). At TReDS, auctioning of invoices at competitive & transparent environment is done by financiers based on Buyer's credit profile.
- ii) MDL is registered on the "Invoicemart" TReDS platform, M1xchange of M/s Mynd Solutions Pvt. Ltd. and M/s Receivables Exchange of India Limited (RIXL).
- iii) MSME bidders desirous to receive payments through TReDS platform may avail the facility if they are already registered on
  - a) "Invoicemart" TReDS platform or by registering on it.  
Contact details at "Invoicemart" TReDS platform are as below:  
022 6235 7373 and a new mail id service@invoicemart.com.
  - b) "M1xchange" TReDS platform or by registering on it.  
Contact details at "M1xchange" TReDS platform are as below:  
Shaiwal Sinha, Mob: 9599224594, Mail : shaiwal.sinha@m1xchange.com  
Ankit Singh, Mob : 9800250395, Mail : ankit.singh@m1xchange.com
  - c) "M/s Receivables Exchange of India Limited (RIXL)" TReDS platform or by registering on it.  
Contact details at M/s Receivables Exchange of India Limited (RIXL) are as below:  
Mr. Santosh Yadav, Senior Relationship Manager Business Development  
Mobile: +91 9167708156, Email: santosh.yadav@rxil.in , Website: www.rxil.in

### 9. E Invoice: Bidder, whose aggregate turnover in any preceding financial year from FY 2017-18 onwards, exceeds INR 5 crore as per GST Act or as applicable from time to time, will have to submit an e- Invoice with a Quick Response (QR) code and Invoice Registration No.(IRN).

Wherever GST is applicable, payment will be released against e-Invoice, or Invoice accompanied with Vendor's Self Declaration that " We do not fall under the category of registered persons notified under Rule 48(4) of the Central GST Rules, 2017 and we are not required to comply with e-Invoicing provisions under GST Act, as our aggregate turnover in any preceding financial year from 2017-18 onwards has not exceeded Rs. 5 Crores as per GST act".

### 10. Consignee:

- (a) Material to be delivered at: Mazagon Dock Shipbuilders Limited, Dockyard Road, Mumbai -400010.
- (b) In order to avoid inconvenience during the delivery of material, it is advisable for supplier to depute their representative in their own interest to coordinate the activities between the transporter, and MDL stores.
- (c) Following document should be submitted along with material:



## Mazagon Dock Shipbuilders Limited, Mumbai

- i. PO copy & subsequent amendments issued to it, if any.
- ii. Mill Test Certificate if applicable as per tender.
- iii. Delivery Challans clearly indicating MDL GeM Contract No.
- iv. Packing List co-relating the items in the MDL GeM Contract No.
- v. Copy of Warranty/Guarantee certificate and Preservation Certificate etc. as applicable
- vi. E-Way bill (if applicable)
- vii. GeM Invoice and Commercial Invoice

**Note:** 1. Any discrepancy, shortfall, mismatch, incompleteness in above documents may lead to delay in CRAC/GRN and subsequent payment, for which MDL shall not be held responsible."

**Note:** 2. MDL reserves the right to test the supplied product at Govt. or NABL lab for verifying the compliance of the supplied products to the specification of the PO. If the test result confirms the compliance of the product to the specification of the PO, then the testing charges shall be borne by MDL. However, if the test result confirms non-compliance of the product to the specification of the PO, then the whole lot shall be rejected and the testing charges shall be recovered from the supplier.

11. **Receipt Inspection:** MDL inspection cell shall carry out necessary inspection of the items on receipt of item at MDL stores. Any objection raised by MDL inspection cell against quality of materials or workmanship shall be satisfactorily corrected by the Contractor at his expense including replacement as may be required within shortest possible time within 30 days. Items damaged during transit shall also be rectified/replaced by the Contractor within shortest possible time. Goods accepted by the purchaser at the initial and final inspections, in terms of the contract, shall in no way dilute the purchaser's right to reject them later, if found deficient in terms of the warranty clause of the contract.
12. **Independent External Monitors (IEM):** The following Independent External Monitors (IEMs) will have the power to access the entire project document and examine any complaints received by him. In case of any change in IEMs it will be informed accordingly. For any administrative enquires and clarification on tender, bidders shall contact Commercial Dealing Executive. In case of issues related to Integrity Pact (IP) please contact Independent External Monitor (IEM) whose details are as below:
  - i) Mr. Subhash Chandra  
Email id: subhash59@hotmail.com
  - ii) Mr. P V Rao  
Email id: pasupuletirao@yahoo.co.in
13. **Book Examination Clause:** In case it is found to the satisfaction of the BUYER that the seller has engaged an Agent or paid commission or influenced any person to obtain the contract as described in clauses relating to Agents/Agency commission and penalty for use of undue influence, the seller, on a specific request of the buyer shall provide necessary information/Break-up data/ inspection of the relevant financial documents/information.
14. **Working on MDL Holidays:** Intimation for working on Saturday / Sunday / holidays if required, should be submitted 2 working days prior to the date of holiday indicating names of personnel to Personnel Department and Security through concerned Department.
15. **Conflict of Interest among Bidders/ Agents:** A bidder shall not have conflict of interest with other bidders. Such conflict of interest can lead to anti-competitive practices to the detriment of MDL's interests. The bidder found to have a conflict of interest shall be disqualified. A bidder may be considered to have a conflict of interest with one or more parties in this bidding process, if:
  - (i) they have controlling partner (s) in common; or



## Mazagon Dock Shipbuilders Limited, Mumbai

- (ii) they receive or have received any direct or indirect subsidy/ financial stake from any of them; or
- (iii) they have the same legal representative/agent for purposes of this bid; or
- (iv) they have relationship with each other, directly or through common third parties, that puts them in a position to have access to information about or influence on the bid of another Bidder; or
- (v) Bidder participates in more than one bid in this bidding process. Participation by a Bidder in more than one Bid will result in the disqualification of all bids in which the parties are involved. However, this does not limit the inclusion of the components/ sub-assembly/ Assemblies from one bidding manufacturer in more than one bid.
- (vi) Either Manufacturer or his only 1 authorized dealer/agent fulfilling the governing criteria can quote against this tender. In case offer is received from both Manufacturer and authorized dealer/agent, only bid from Manufacturer shall be considered for further processing and the bid of dealer/agent shall be rejected. One Manufacturer can authorize only 1 dealer in case manufacturer is not quoting/submitting their bid. In case of bids are received from more than 1 authorized dealer/agent of same manufacturer, their bids will be rejected." This is prescribed considering THE STRATEGIC NATURE OF ITEM & with a purpose for having the attributive consistency in supply of steel plates and for avoidance of price play and for restricting anti-competitive practice in bidding process being open tender.
- (vii) In case of a holding company having more than one independently manufacturing units, or more than one unit having common business ownership/management, only one unit should quote. Similar restrictions would apply to closely related sister companies. Bidders must proactively declare such sister/ common business/ management units in same/ similar line of business.

**Note: Participation of any bidder in this tender is construed as the bidder unconditionally agree and abide by the content of undertaking at Enclosure 2.**

16. **Contacting MDL during the evaluation:** From the time of bid submission to awarding the contract, no bidder shall contact MDL on any matter relating to the submitted bid. If a Bidder needs to contact MDL for any reason relating to this tender and/ or its bid, it should do so only in writing or electronically. Any effort by a Bidder to influence MDL during the processing of bids, evaluation, bid comparison or award decisions shall be construed as a violation of the Code of Integrity, and bid shall be liable to be rejected as nonresponsive in addition to other punitive actions for violation of Code of Integrity as per the Tender Document.
17. **Cartel Formation/Pool Rates:** It is possible that sometimes a group of bidders quote the same rate against a tender. Such pool/cartel formation is against the basic principle of competitive bidding and defeats the very purpose of an open and competitive tendering system. Such and similar tactics to avoid/control true competition in a tender leading to "Appreciable Adverse Effect on Competition" (AAEC) have been declared as an offence under the Competition Act, 2002, as amended by the Competition (Amendment) Act, 2007. In case of evidence of cartel formation, detailed cost analysis may be done by associating experts if necessary. Besides, suitable administrative actions can be resorted to, such as rejecting the offers, reporting the matter to trade associations, the Competition Commission or NSIC, etc., and requesting them, inter-alia, to take suitable strong actions against such firms. Purchaser may also debar the tenderers indulging in cartel formation/collusive bidding/bid rigging for a period of two years from participation in the tenders of the Purchaser.
18. **Scrutiny of offers:** Bidders to ensure the completeness and clarity in their online offer by ensuring that complete/relevant documents/details required as per tender are uploaded **ALONG WITH THEIR PART I ONLINE BID on GeM PORTAL**. During evaluation and comparison of bids, MDL may, at its discretion, ask the bidder for clarifications on the bid. In case of shortfall documents, opportunity may be given to the bidder to submit the shortfall/supportive document through GeM portal. Bidder to note that The shortfall information/documents will be sought only in case of historical documents which pre-existed at the time of the tender opening and which have not undergone change since then.



## Mazagon Dock Shipbuilders Limited, Mumbai

**Bidders shall regularly check their GeM bid status on GeM portal for any such clarifications.** Bidders are expected to provide clarification before the deadline on GeM portal. If the bidder does not comply or respond by the date, his offer will be liable to be rejected.

**No change in prices or substance of the bid shall be sought, offered or permitted. No post-bid clarification at the initiative of the bidder shall be entertained.**

**19. Additional Instructions:**

- (a) The bidder shall also abide to all statutory requirements, Official Secret Act 1923, Security and Safety Rules as per references, which are part of this tender. If contractors' employees are not adhering to the health, safety and environment norms and the contractors not equipping their employees with suitable safety gears, will be viewed seriously. For non-adherence to above will be levied as per extant guidelines of Security and Safety Rules prevailing time to time, to the contractor without prejudice to other rights to enforce the safety requirements.
- (b) MDL shall not be bound by any printed conditions or provisions in the sellers bid forms or acknowledgement of contract, invoices, packing list and any other documents which purport to impose any conditions at variance with the tender terms / final negotiated & accepted terms.

**20. Contact Details for Queries:** All bidders are requested to get their queries, if any, clarified in advance (i.e. 7 days in advance to tender closing date) to avoid last minute delay. In case of any clarifications regarding tender, bidders are requested to contact the following executives.

Mr. Nikesh Parate, CM(C-MP)	022-23763320	ntparate@mazdock.com
Mr. Rajesh S. Paulastye, DGM (Materials-Special Procurement)	022-23763252	rspaulastye@mazdock.com

**21. Right to reject any or all bids:** MDL reserves its right to accept or reject any or all bids, abandon / cancel the tender process, and issue another tender for the same or similar Goods/Services at any time before the award of the contract.

**Enclosures: -**

Enclosure-1	Integrity Pact
Enclosure-2	Undertaking regarding conflict of interest
Enclosure-3	Confirmation of being manufacturer of offered product
Enclosure-4	Official Secret Act 1923
Enclosure-5	Drawing for tender item no 08 (Material Code no. 18701961)
Enclosure-6	Drawing for tender item no 30 (Material Code no. 18707426)



# Mazagon Dock Shipbuilders Limited, Mumbai

Enclosure-1

## INTEGRITY PACT

**Mazagon Dock Shipbuilders Limited (MDL)** hereinafter referred to as "**The Principal/Buyer**"

And.....hereinafter referred to as "**The Bidder/ Contractor**"

### **PREAMBLE**

	The Principal/Buyer intends to award, under laid down organizational procedures, contract/s for .....The Principal/Buyer values full compliance with all relevant laws of the land rules, regulations, economic use of resources and of fairness / transparency in its relations with its Bidder(s) and /or Contractor(s). In order to achieve these goals, the Principal/Buyer will appoint an Independent External Monitor (IEM), who will monitor the tender process and the execution of the contract for compliance with the principles mentioned above.
--	--

### **Section 1 - Commitments of the Principal/Buyer:**

(1)	The Principal/Buyer commits itself to take all measures necessary to prevent corruption and to observe the following principles:
a)	No employee of the Principal/Buyer, personally or through family members, will in connection with the tender for, or the execution of a contract, demand, take a promise for or accept, for self or third person, any material or immaterial benefit which the person is not legally entitled to.
b)	The Principal/Buyer will during the tender process treat all Bidder(s) with equity and reason. The Principal/Buyer will in particular, before and during the tender process, provide to all Bidder(s) the same information and will not provide to any Bidder(s) confidential/additional information through which the Bidder(s) could obtain an advantage in relation to the tender process or the contract execution.
c)	The Principal/Buyer will exclude from the process all known prejudiced persons.
d)	The Principal/Buyer undertakes to scrupulously follow the tender containing General Conditions of Contract (GCC) in respect of procurement contracts for goods, services and civil works.
(2)	If the Principal/Buyer obtains information on the conduct of any of its employees which is a criminal offence under the relevant Anti Corruption Laws of India, or if there be a substantive suspicion in this regard, the Principal/Buyer will inform the Chief Vigilance Officer, MDL and in addition can initiate disciplinary actions.

### **Section 2 - Commitments of the Bidder(s)/Contractor(s):**

(1)	The Bidder(s)/Contractor(s) commit himself to take all measures necessary to prevent corruption. He commits himself to observe the following principles during his participation in the tender process and during the contract execution.
a)	The Bidder(s)/Contractor(s) will not, directly or through any other persons or firm, offer promise or give to any of the Principal/Buyer's employees involved in the tender process or the execution of the contract or to any third person any material or other benefit which he/she is not legally entitled to, in order to obtain in exchange any advantage or any kind whatsoever during the tender process or during the execution of the contract.
b)	The Bidder(s)/Contractor(s) will not enter with other Bidders into any undisclosed agreement or understanding, whether formal or informal. This applies in particular to prices, specifications, certifications, subsidiary contracts, submission or non-submission of bids or any other actions to restrict competitiveness or to introduce cartelization in the bidding process.
c)	The Bidder(s)/Contractor(s) will not commit any offence under the relevant Anti-Corruption Laws of India; further the Bidder(s)/Contractor(s) will not use improperly, for purposes of competition or personal gain, or pass on to other, any information or document provided by the Principal/Buyer as part of the business relationship, regarding plans, technical proposals and business details, including information contained or transmitted electronically.



## Mazagon Dock Shipbuilders Limited, Mumbai

d)	The Bidder(s)/Contractor(s) of foreign origin shall disclose the name and address of the Agents/representatives in India, if any. Similarly, the Bidder(s)/Contractor(s) of Indian Nationality shall furnish the name and address of the foreign principals, if any. All payments made to the Indian Agent/representative have to be in Indian Rupees only. Further details as mentioned in the "Guidelines of Indian Agents of Foreign suppliers" shall be disclosed by the Bidders(s)/Contractor(s). Copy of the "Guidelines on Indian Agents of Foreign Suppliers" as annexed and marked as Annexure-A.
e)	The Bidder(s)/Contractor(s) will when presenting his bid, disclose any and all payments he has made, is committed to or intends to make to agents, brokers or any other intermediaries in connection with the award of the contract.
f)	The Bidder (s)/Contractor(s), their agents, representatives shall not do such things so as to interfere with the procedures laid down in the Principal/Buyer's tender containing the General Conditions of Contract (GCC) in respect of procurement contracts for goods, services and civil works.
g)	The Bidder commits to refrain from giving any complaint directly or through any other manner without supporting it with full and verifiable facts.
(2)	The Bidder(s)/Contractor(s) will not instigate third persons to commit offences outlines above or be an accessory to such offences.

### **Section 3 - Disqualification from tender process and exclusion from future contracts:**

	If the Bidder(s)/Contractor(s) before contract award or during execution of Contract has committed a transgression through a violation of Section 2, above or in any other form such as to put his reliability or credibility as Bidder(s) in question, the Principal/Buyer is entitled to disqualify the Bidder(s)/Contractor(s) from the tender process or to terminate the contract, if already signed for such reason, as per the procedure mentioned in the "Guidelines on Banning of business dealings" Copy of the "Guidelines on Banning of business dealings" is annexed and marked as Annexure-B.
1)	If the Bidder(s)/Contractor(s) has committed a transgression through a violation of Section 2 such as to put his reliability or credibility into question, the Principal/Buyer is entitled also to exclude the Bidder(s)/Contractor(s) from future contract award processes. The imposition and duration of the exclusion will be determined by the severity of the transgression. The severity will be determined by the circumstances of the case, in particular the number of transgressions, the position of the transgressors within the company hierarchy of the Bidder(s) and the amount of the damage. The exclusion will be imposed for a minimum of <u>six</u> months and maximum of <u>five</u> years, which may be further extended at the discretion of the Principal/Buyer.
2)	A transgression is considered to have occurred, if the Principal/Buyer after due consideration of the available evidence, concludes that no reasonable doubt is possible.
3)	The Bidder (s) accepts and undertakes to respect and uphold the Principal/Buyer's absolute right to resort to and impose such exclusion and further accepts and undertakes not to challenge or question such exclusion on any ground, including the lack of any hearing before the decision to resort to such exclusion is taken. This undertaking is given freely and after obtaining legal advice.
4)	If the Bidder(s)/Contractor(s) can prove that he has restored/ recouped the damage caused by him and has installed a suitable corruption prevention system, the Principal/Buyer may revoke the exclusion prematurely.

### **Section 4 – Sanctions for Violation:**

(1)	Any breach of the aforesaid provisions by the Bidder or any one employed by him or acting on his behalf (whether with or without the knowledge of the Bidder) or the commission of any offence by the Bidder or any one employed by him or acting on his behalf, as defined in Chapter IX of the Indian Penal Code, 1860 or the Prevention of Corruption Act 1988 or any other Act enacted for the prevention of corruption shall entitle the Principal/Buyer to take all or any one of the following actions, wherever required –
a)	To immediately call off the pre-contract negotiations without assigning any reason or giving any compensation to the Bidder. However, the proceedings with the other Bidder (s) would continue.
b)	The Earnest Money Deposit/Security Deposit/Performance Bond shall stand forfeited either fully or



## Mazagon Dock Shipbuilders Limited, Mumbai

	partially, as decided by the Principal/Buyer, and the Principal/Buyer shall not be required to assign any reason there for.
c)	To immediately cancel the contract, if already signed, without giving any compensation to the Bidder.
d)	To recover all sums already paid by the Principal/Buyer, in case of an Indian Bidder with interest thereon at 2% higher than the prevailing Base Rate of SBI, and in case of a Bidder from a country other than India with interest thereon at 2% higher than the LIBOR. If any outstanding payment is due to the Bidder from the Buyer in connection with any other contract for any other Defence stores, such outstanding payment could also be utilized to recover the aforesaid sum and interest.
e)	To en-cash the advance Bank Guarantee and Performance Bond/Warranty bond, if furnished by the Bidder, in order to recover the payments, already made by the Principal/Buyer, along with interest.
f)	To cancel all or any other contracts with the Bidder.
g)	To debar the Bidder from entering into any bid from Principal/Buyer for a minimum period of five years, which may be further extended at the discretion of the Principal/Buyer.
h)	To recover all sums paid in violation of this Pact by Bidder(s) to any middleman or agent or broker with a view to securing the contract.
i)	If the Bidder or any employee of the Bidder or any person acting on behalf of the Bidder, either directly or indirectly, is closely related to any of the officers of the Buyer, or alternatively, if any close relative of an officer of the Buyer has financial interest/stake in the Bidder's firm, the same shall be disclosed by the Bidder at the time of filing of tender. Any failure to disclose the interest involved shall entitle the Buyer to rescind the contract without payment of any compensation to the Bidder.
	The term 'close relative' for this purpose would mean spouse whether residing with the Principal/Buyer's employee/employees or not, but not include a spouse separated from the Principal/Buyer's employee/employees by a decree or order of a competent court; son or daughter or step son or step daughter and wholly dependent upon Principal/Buyer's employee/employees, but does not include a child or step child who is no longer in any way dependent upon the Principal/Buyer's employee/employees or of whose custody the Principal/Buyer's employee/employees has been deprived of by or under any law; any other person related, whether by blood or marriage, to the Principal/Buyer's employee/employees or to the Principal/Buyer's employee/employees wife or husband and wholly dependent upon Principal/Buyer's employee/employees.
j)	The Bidder shall not lend to or borrow any money from or enter into any monetary dealings or transactions, directly or indirectly, with any employee of the Principal/Buyer, and if he does so, the Principal/Buyer shall be entitled forthwith to rescind the contract and all other contracts with the Bidder. The Bidder shall be liable to pay compensation for any loss or damage to the Principal/Buyer resulting from such rescission and the Principal/Buyer shall be entitled to deduct the amount so payable from the money(s) due to the Bidder.
k)	In cases where Irrevocable Letters of Credit have been received in respect of any contract signed by the Principal/Buyer with the Bidder, the same shall not be opened.
(2)	The decision of the Principal/Buyer to the effect that a breach of the provisions of this Integrity Pact has been committed by the Bidder shall be final and binding on the Bidder, however, the same Bidder can approach the Monitor(s) appointed for the purposes of this Pact.

### **Section 5 - Previous Transgression:**

(1)	The Bidder declares that no previous transgressions occurred in the last three years with any other company in any country conforming to the anti-corruption approach or with any other public sector enterprise in India that could justify his exclusion from the tender process.
(2)	If the bidder makes incorrect statement on this subject, he can be disqualified from the tender process or further action can be taken.

### **Section 6 - Equal treatment of all Bidders/Contractor(s)/Subcontractors:**

(1)	The Bidder(s)/Contractor(s) undertake(s) to demand from all subcontractors a commitment in conformity with this integrity Pact, and to submit it to the Principal before contract signing.
-----	--



## Mazagon Dock Shipbuilders Limited, Mumbai

2)	The Principal/Buyer will enter into agreements with identical conditions as this one with all bidders, contractors and subcontractors.
(3)	The Principal/Buyer will disqualify from the tender process all bidders who do not sign this Pact or violate its provisions.

### **Section 7 - Criminal charges against violation Bidder(s)/Contractor(s)/ Subcontractor(s):**

(1)	If the Principal/Buyer obtains knowledge of conduct of a Bidder, Contractor or subcontractor, or of an employee or a representative or an associate of a Bidder, Contractor or subcontractor which constitutes corruption or if the Principal has substantive suspicion in this regard, the Principal/Buyer will inform the same to the Chief Vigilance Officer, MDL.
-----	---

### **Section 8 - Independent External Monitor/Monitors:**

(1)	The Principal/Buyer appoints competent and credible independent External Monitor for this Pact. The task of the Monitor is to review independently and objectively whether and to what extent the parties comply with the obligations under this agreement.
(2)	The Monitor is not subject to instructions by the representatives of the parties and performs his functions neutrally and independently. He reports to the Chairman & Managing Director of the Principal/Buyer.
(3)	The Bidder(s)/Contractor(s) accepts that the Monitor has the right to access without restriction to all project documentation of the Principal/Buyer including that provided by the Contractor. The Contractor will also grant the Monitor, upon his request and demonstration of a valid interest, unrestricted and unconditional access to his project documentation. The same is applicable to Subcontractors. The Monitor is under contractual obligation to treat the information and documents of the Bidder(s)/Contractor(s)/Subcontractor(s) with confidentiality.
(4)	The Principal/Buyer will provide to the Monitor sufficient information about all meetings among the parties related to the Project provided such meetings could have an impact on the contractual relations, between the Principal/Buyer and the Contractor. The parties offer to the Monitor the option to participate in such meetings.
(5)	As soon as the Monitor notices, or believes to notice, a violation of this agreement, he will so inform the Management of the Principal/Buyer and request the Management to discontinue or take corrective action, or to take other relevant action. The Monitor can in this regard submit non-binding recommendations. Beyond this, the Monitor has no right to demand from the parties that they act in a specific manner, refrain from action or tolerate action. However, the Monitor shall give an opportunity to the Bidder(s)/Contractor(s) to present its case before making its recommendation to the Principal/Buyer.
(6)	The Monitor will submit a written report to the Chairman & Managing Director of the Principal within 8 to 10 weeks from the date of reference or intimation to him by the Principal/Buyer and, should the occasion arise, submit proposals for correcting problematic situations.
(7)	Monitor shall be entitled to compensation on the same terms as being extended to / provided to Independent Directors on the Board of Principal/Buyer.
(8)	If the Monitor has reported to the Chairman & Managing Director of the Principal, a substantiated suspicion of an offence under relevant Anti-Corruption Laws of India and the Chairman & Managing Director of the Principal/Buyer has not, within the reasonable time taken visible action to proceed against such offence or reported it to the Chief Vigilance Officer, the Monitor may also transmit this information directly to the Central Vigilance Commissioner, Government of India.
(9)	The word 'Monitor' would include both singular and plural.

### **Section 9 - Pact Duration:**

	<p>This pact begins when both parties have legally signed it. It expires for the Contractor <b>12 months</b> after the last payment under the contract and for all other Bidders <b>06 months</b> after the contract has been awarded.</p> <p>If any claim is made / lodged during this time, the same shall be binding and continue to be valid despite the lapse of this pact as specified above unless it is discharged / determined by Chairman &amp; Managing Director of the Principal/Buyer.</p>
--	---

### **Section 10 - Other provisions:**



# Mazagon Dock Shipbuilders Limited, Mumbai

(1)	This agreement is subject to Indian Law, place of performance and jurisdiction is the Registered Office of the Principal/Buyer, i.e. Mumbai (For MDL). The Arbitration clauses provided in the main tender document/ contract shall not be applicable for any issue/dispute arising under this Integrity pact.
(2)	Changes and supplements as well as termination notices need to be made in writing. Side agreements have not been made.
(3)	If the Contractor is a partnership or a consortium, this agreement must be signed by all partners or consortium members.
(4)	Should one or several provisions of this agreement turn out to be invalid, the remainder of this agreement remains valid. In this case, the parties will strive to come to an agreement to their original intentions.

### Section 11 – Fall Clause: #

“The Bidder undertakes that it has not supplied/is not supplying similar products/ systems or subsystems at a price lower than that offered in the present bid in respect of any other Ministry/Department of the Government of India or PSU and if it is found at any stage that similar product/systems or sub systems was supplied by the Bidder to any other Ministry/Department of the Government of India or a PSU at a lower price, then that very price, with due allowance of elapsed time, will be applicable to the present case and the difference in the cost would be refunded by the Bidder to the Principal/Buyer, if the contract has already been concluded.”

For & on behalf of  
 MAZAGON DOCKSHIPBUILDERS LIMITED  
 (Office Seal)  
 Place \_\_\_\_\_  
 Date \_\_\_\_\_

For & on behalf of  
 Bidder/Contractor  
 (Office Seal)

Witness 1:  
 (Name & Address)  
 \_\_\_\_\_  
 \_\_\_\_\_  
 \_\_\_\_\_

Witness 2:  
 (Name & Address)  
 \_\_\_\_\_  
 \_\_\_\_\_  
 \_\_\_\_\_



## Mazagon Dock Shipbuilders Limited, Mumbai

Annexure-A to IP

### **GUIDELINES FOR INDIAN AGENTS OF FOREIGN SUPPLIERS**

1.0	There shall be compulsory registration of agents for all Global (Open) Tender and Limited Tender. An agent who is not registered with MDL shall apply for registration.	
1.1	An agent shall represent only one Foreign Supplier and not represent two suppliers or quote on their behalf in the same tender.	
	However, either the Indian Agent on behalf of the Foreign Suppliers (also includes foreign manufacturers) or the Foreign Suppliers (also includes foreign manufacturers) directly could bid in a tender, but not both. In cases where an agent participates in a tender on behalf of one manufacturer, shall not quote on behalf of another manufacturer along with the first Manufacturer in a subsequent/parallel tender for the same item.	
1.2	Registered agents will file an authenticated Photostat copy duly attested by a Notary Public/Original certificate of the principal confirming the agency agreement and giving the status being enjoyed by the agent and the commission/remuneration/salary/ retainer ship being paid by the principal to the agent before the placement of order by MDL.	
1.3	Wherever the Indian representatives have communicated on behalf of their principals and the foreign parties have stated that they are not paying any commission to the Indian agents, and the Indian representative is working on the basis of salary or as retainer, a written declaration to this effect should be submitted by the party (i.e. Principal) before finalizing the order.	
<b>2.0</b>	<b>DISCLOSURE OF PARTICULARS OF AGENTS/ REPRESENTATIVES IN INDIA, IF ANY.</b>	
2.1	Tenderers of Foreign nationality shall furnish the following details in their offer:	
	2.1.1	The name and address of the agents/representatives in India, if any and the extent of authorization and authority given to commit the Principals. In case the agent/representative be a foreign Company, it shall be confirmed whether it is real substantial Company and details of the same shall be furnished.
	2.1.2	The amount of commission/remuneration included in the quoted price(s) for such agents/representatives in India.
	2.1.3	Confirmation of the Tenderer that the commission/ remuneration if any, payable to his agents/ representatives in India, may be paid by MDL in Indian Rupees only.
2.2	Tenderers of Indian Nationality shall furnish the following details in their offers:	
	2.2.1	The name and address of the foreign principals indicating their nationality as well as their status, i.e, whether manufacturer or agents of manufacturer holding the Letter of Authority of the Principal specifically authorizing the agent to make an offer in India in response to tender either directly or through the agents/representatives.
	2.2.2	The amount of commission/remuneration included in the price (s) quoted by the Tenderer for himself.
	2.2.3	Confirmation of the foreign principals of the Tenderer that the commission/remuneration, if any, reserved for the Tenderer in the quoted price (s), may be paid by MDL in India in equivalent Indian Rupees on satisfactory completion of the Project or supplies of Stores and Spares in case of operation items .
2.3	In either case, in the event of contract materializing, the terms of payment will provide for payment of the commission /remuneration, if any payable to the agents/representatives in India in Indian Rupees on expiry of 90 days after the discharge of the obligations under the contract.	
2.4	Failure to furnish correct and detailed information as called for in paragraph-2.0 above will render the concerned tender liable to rejection or in the event of a contract materializing, the same liable to termination by MDL. Besides this there would be a penalty of banning business dealings with MDL or damage or payment of a named sum.	



# Mazagon Dock Shipbuilders Limited, Mumbai

Annexure-B to IP

## GUIDELINES ON BANNING OF BUSINESS DEALINGS CONTENTS

Sr.	Description
1.	Introduction
2.	Scope
3.	Definitions
4.	Initiation of Banning / Suspension
5.	Suspension of Business Dealings
6.	Ground on which Banning of Business Dealing can be initiated
7.	Banning of Business Dealings
8.	Removal from List of Approved Agencies-Suppliers/ Contractors etc.
9.	Procedure for issuing Show-cause Notice
10.	Appeal against the Decision of the Competent Authority
11.	Review of the Decision by the Competent Authority
12.	Circulation of the names of Agencies with whom Business Dealings have been banned

### 1. Introduction

1.1	Mazagon Dock Shipbuilders Limited (MDL), being a Public Sector Enterprise and 'State', within the meaning of Article 12 of Constitution of India, has to ensure preservation of rights enshrined in Chapter III of the Constitution. MDL as also to safeguard its commercial interests. MDL deals with Agencies, who have a very high degree of integrity, commitments and sincerity towards the work undertaken. It is not in the interest of MDL to deal with Agencies who commit deception, fraud or other misconduct in the execution of contracts awarded / orders issued to them. In order to ensure compliance with the constitutional mandate, it is incumbent on MDL to observe principles of natural justice before banning the business dealings with any Agency.
1.2	Since banning of business dealings involves civil consequences for an Agency concerned, it is incumbent that adequate opportunity of hearing is provided and the explanation, if tendered, is considered before passing any order in this regard keeping in view the facts and circumstances of the case.

### 2. Scope

2.1	MDL reserves its rights to remove from list of approved suppliers / contractors or to ban business dealings if any Agency has been found to have committed misconduct and also to suspend business dealings pending investigation.
2.2	Similarly, in case of sale of material there is a clause to deal with the Agencies / customers / buyers, who indulge in lifting of material in unauthorized manner.
2.3	However, absence of such a clause does not in any way restrict the right of MDL to take action / decision under these guidelines in appropriate cases.
2.4	The procedure of (i) Removal of Agency from the List of approved suppliers / contractors; (ii) Suspension and (iii) Banning of Business Dealing with Agencies, has been laid down in these guidelines.
2.5	These guidelines apply to all the Divisions/Yards of MDL.
2.6	It is clarified that these guidelines do not deal with the decision of the Management not to entertain any particular Agency due to its poor / inadequate performance or for any other reason.
2.7	The banning shall be with prospective effect, i.e., future business dealings.

### 3. Definitions

In these Guidelines, unless the context otherwise requires:

i)	'Bidder / Contractor / Supplier / Purchaser / Customer' shall mean and include a public limited company or a private limited company, a firm whether registered or not, an individual, a cooperative society or an association or a group of persons engaged in any commerce, trade, industry, etc. 'Bidder / Contractor / Supplier / Purchaser / Customer' in the context of these guidelines is indicated as 'Agency'.
ii)	'Inter-connected Agency' shall mean two or more companies having any of the following features:
a)	If one is a subsidiary of the other.



## Mazagon Dock Shipbuilders Limited, Mumbai

b)	If the Director(s), Partner(s), Manager(s) or Representative(s) are common;
c)	If management is common;
d)	If one owns or controls the other in any manner;
iii)	'Competent Authority' and 'Appellate Authority' shall mean the following:
a)	Functional Director shall be the 'Competent Authority' for the purpose of these guidelines. CMD, MDL shall be the 'Appellate Authority'.
b)	CMD, MDL shall have overall power to take suo-moto action on any information available or received by him and pass such order(s) as he may think appropriate, including modifying the order(s) passed by any authority under these guidelines.
iv)	'Investigating Department' shall mean any Department or Unit investigating into the conduct of the Agency and shall include the Vigilance Department, Central Bureau of Investigation, the State Police or any other department set up by the Central or State Government having powers to investigate.
v)	'List of approved Agencies – 'Bidder / Contractors / Suppliers / Purchasers / Customers shall mean and include list of approved / registered Agencies - 'Bidder / Contractors / Suppliers / Purchasers / Customers, etc.

#### 4. Initiation of Banning / Suspension

	Action for banning / suspension business dealings with any Agency should be initiated by the department having business dealings with them after noticing the irregularities or misconduct on their part. Besides the concerned department, Vigilance Department may also be competent to initiate such action.
--	---

#### 5. Suspension of Business Dealings

5.1	If the conduct of any Agency dealing with MDL is under investigation by any department, the Competent Authority may consider whether the allegations under investigation are of a serious nature and whether pending investigation, it would be advisable to continue business dealing with the Agency. If the Competent Authority, after consideration of the matter including the recommendation of the Investigating Department, if any, decides that it would not be in the interest to continue business dealings pending investigation, it may suspend business dealings with the Agency. The order to this effect may indicate a brief of the charges under investigation. If it is decided that inter-connected Agencies would also come within the ambit of the order of suspension, the same should be specifically stated in the order. The order of suspension would operate for a period not more than six months and may be communicated to the Agency as also to the Investigating Department. The Investigating Department may ensure that their investigation is completed and whole process of final order is over within such period.
5.2	The order of suspension shall be communicated to all Commercial Departmental Heads. During the period of suspension, no business dealing may be held with the Agency.
5.3	As far as possible, the existing contract(s) with the Agency may continue unless the Competent Authority, having regard to the circumstances of the case, decides otherwise.
5.4	If the gravity of the misconduct under investigation is very serious and it would not be in the interest of MDL, as a whole, to deal with such an Agency pending investigation, the Competent Authority may order suspension of business dealing with Agency and send his recommendation to Chief Vigilance Officer (CVO), MDL along with the material available, copy of which may be issued to the Agency concerned with intimation to CVO MDL. Such an order would operate for a period of six months from the date of issue.
5.5	If the Agency concerned asks for detailed reasons of suspension, the Agency may be informed that its conduct is under investigation. It is not necessary to enter into correspondence or argument with the Agency at this stage.
5.6	It is not necessary to give any show-cause notice or personal hearing to the Agency before issuing the order of suspension. However, if investigations are not complete in six months' time, the Competent Authority may extend the period of suspension by another three months, during which period the investigations must be completed.

#### 6. Ground on which Banning of Business Dealings can be initiated

6.1	If the security consideration, including questions of loyalty of the Agency to the State, so warrants;
6.2	If the Director / Owner of the Agency, proprietor or partner of the firm, is convicted by a Court of Law for offences involving moral turpitude in relation to its business dealings with the Government or any other public sector enterprises or MDL, during the last five years;
6.3	If there is strong justification for believing that the Directors, Proprietors, Partners, owner of the Agency have been guilty of malpractices such as bribery, corruption, fraud, substitution of tenders, interpolations,



## Mazagon Dock Shipbuilders Limited, Mumbai

	etc;
6.4	If the Agency continuously refuses to return / refund the dues of MDL without showing adequate reason and this is not due to any reasonable dispute which would attract proceedings in arbitration or Court of Law;
6.5	If the Agency employs a public servant dismissed / removed or employs a person convicted for an offence involving corruption or abetment of such offence;
6.6	If business dealings with the Agency have been banned/blacklisted by Government Agencies/ Statutory bodies, DGQA, Defence Shipyards, DPSUs or with whom commercial transactions have been suspended for sufficient and justifiable reasons. If the Agency having same promoters/Directors /Partners as the barred/blacklisted Company as at 6.6 above for the duration for which the barring/ blacklisting of sister concern persists.
6.7	If the Agency has resorted to Corrupt, fraudulent practices including misrepresentation of facts; If the agency who had fraudulently dealt with the Company for pecuniary gains or had connived with dealing officers for mutual benefit.
6.8	If the Agency uses intimidation / threatening or brings undue outside pressure on the MDL or its official in acceptance / performances of the job under the contract;
6.9	If the Agency indulges in repeated and / or deliberate use of delay tactics in complying with contractual stipulations;
6.10	Wilful indulgence by the Agency in supplying sub-standard material irrespective of whether pre-dispatch inspection was carried out by MDL or not;
6.11	Based on the findings of the investigation report of CBI / Police against the Agency for malafide / unlawful acts or improper conduct on his part in matters relating to the MDL or even otherwise;
6.12	Established litigant nature of the Agency to derive undue benefit;
6.13	Continued poor performance of the Agency in several contracts;
6.14	If the Agency misuses the premises or facilities of the MDL, forcefully occupies, tampers or damages the Company's properties including land, water resources, forests / trees, etc. If the Agency who knowingly collude to defeat competition with the aim of deriving undeserved profit or gain from doing business with MDL. (Note: The examples given above are only illustrative and not exhaustive. The Competent Authority may decide to ban business dealing for any good and sufficient reason).

### 7. Banning of Business Dealings

7.1	Decision to ban business dealings with any Agency would apply throughout the Company.
7.2	There will be a Standing Committee to be appointed by the CMD which may include HOD of respective Commercial Section/Capital Works/OTS, HOD (M), rep of Legal Dept. and OIC (SR&R) for processing the cases of "Banning of Business Dealings". The functions of the committee shall, inter-alia include: i) To study the report of the Investigating Agency and decide if a prima-facie case for banning exists, if not, send back the case to the Competent Authority. ii) To recommend for issue of show-cause notice to the Agency by the concerned department. iii) To examine the reply to show-cause notice and call the Agency for personal hearing, if required. iv) To submit final recommendation to the Competent Authority for banning or otherwise.
7.3	If the Competent Authority is prima-facie of view that action for banning business dealings with the Agency is called for, a show-cause notice may be issued to the Agency as per paragraph 9.1 and an enquiry held accordingly.

### 8 Removal from List of Approved Agencies - Suppliers / Contractors, etc.

8.1	If the Competent Authority decides that the charge against the Agency is of a minor nature, it may issue a show-cause notice as to why the name of the Agency should not be removed from the list of approved Agencies - Suppliers / Contractors, etc.
8.2	The effect of such an order would be that the Agency would not be disqualified from competing in Open Tender Enquiries but LTE may not be given to the Agency concerned.
8.3	Past performance of the Agency may be taken into account while processing for approval of the Competent Authority for awarding the contract.

### 9. Show-cause Notice

9.1	In case where the Competent Authority decides that action against an Agency is called for, a show-cause notice has to be issued to the Agency. Statement containing the imputation of misconduct or
-----	---



## Mazagon Dock Shipbuilders Limited, Mumbai

	misbehavior may be appended to the show-cause notice and the Agency should be asked to submit within 15 days a written statement in its defence.
9.2	If the Agency requests for inspection of any relevant document in possession of MDL, necessary facility for inspection of documents may be provided.
9.3	The Competent Authority may consider and pass an appropriate speaking order:
	a) For exonerating the Agency if the charges are not established;
	b) For removing the Agency from the list of approved Suppliers / Contactors, etc.
	c) For banning the business dealing with the Agency.
9.4	If it decides to ban business dealings, the period for which the ban would be operative may be mentioned. The order may also mention that the ban would extend to the interconnected Agencies of the Agency.
<b>10. Appeal against the Decision of the Competent Authority</b>	
10.1	The Agency may file an appeal against the order of the Competent Authority banning business dealing, etc. The appeal shall lie to Appellate Authority. Such an appeal shall be preferred within one month from the date of receipt of the order banning business dealing, etc.
10.2	Appellate Authority would consider the appeal and pass appropriate order which shall be communicated to the Agency as well as the Competent Authority.
<b>11. Review of the Decision by the Competent Authority</b>	
	Any petition / application filed by the Agency concerning the review of the banning order passed originally by Competent Authority under the existing guidelines either before or after filing of appeal before the Appellate Authority or after disposal of appeal by the Appellate Authority, the review petition can be decided by the Appellate Authority upon disclosure of new facts / circumstances or subsequent development necessitating such review. The Competent Authority may refer the same petition to the separate Standing Committee which may be constituted by Appellate Authority for examination and recommendation.
<b>12. Circulation of the names of Agencies with whom Business Dealings have been banned</b>	
12.1	Depending upon the gravity of misconduct established, the Competent Authority may direct HOD (Materials)/OIC (SR&R) to circulate the names of Agency with whom business dealings have been banned, to the Government Departments, other Public Sector Enterprises, etc. for such action as they deem appropriate.
12.2	If Government Departments or a Public Sector Enterprise request for more information about the Agency with whom business dealings have been banned, a copy of the report of Inquiring Authority together with a copy of the order of the Competent Authority / Appellate Authority may be supplied.
12.3	If business dealings with any Agency have been banned by the Central or State Government or any other Public Sector Enterprise, MDL may, without any further enquiry or investigation, issue an order banning business dealing with the Agency and its inter-connected Agencies.



**Undertaking regarding conflict of interest**

We do not have any conflict of interest with other bidders. We agree for the following compliance;

1. The bidder found to have a conflict of interest shall be disqualified.
2. A bidder may be considered to have a conflict of interest with one or more parties in this bidding process, if:
  - i. they have controlling partner (s) in common; or
  - ii. they receive or have received any direct or indirect subsidy/ financial stake from any of them; or
  - iii. they have the same legal representative/agent for purposes of this bid; or
  - iv. they have relationship with each other, directly or through common third parties, that puts them in a position to have access to information about or influence on the bid of another Bidder; or
  - v. Bidder participates in more than one bid in this bidding process. Participation by a Bidder in more than one Bid will result in the disqualification of all bids in which the parties are involved. However, this does not limit the inclusion of the components/ sub-assembly/ Assemblies from one bidding manufacturer in more than one bid.
  - vi. In cases of agents quoting in offshore procurements, on behalf of their principal manufacturers, one agent cannot represent two manufacturers or quote on their behalf in a particular tender enquiry. One manufacturer can also authorise only one agent/dealer. There can be only one bid from the following:
    - a) The principal manufacturer directly or through one Indian agent on his behalf; and
    - b) Indian/foreign agent on behalf of only one principal.
  - vii. Bidder or any of its affiliates participated as a consultant in the preparation of the design or technical specifications of the contract that is the subject of the Bid
  - viii. In case of a holding company having more than one independently manufacturing units, or more than one unit having common business ownership/management, only one unit should quote. Similar restrictions would apply to closely related sister companies. Bidders must proactively declare such sister/ common business/ management units in same/ similar line of business.

**SIGNATURE:** \_\_\_\_\_

**DATE:** \_\_\_\_\_

**Seal / Stamp of Bidder**



**Confirmation of being manufacturer of offered product  
(Compliance to Serial no. xiii (m) (i) of Para 4 of General Terms and Conditions on GeM) – To  
be submitted by MSE bidders.**

M/s. ....

Sr. No.	Material Code As per specification	Item Specification / Description	Whether Manufacturer of Offered Product (Yes / No)
1	18700023	BOLT, HEX.HD.4.6 (MS), SIZE M12 x 65 IS-1367, THRDS ISO METRIC CLASS 6g TO IS 4218 CAD PLATED(OR BS-3692), PACKED IN GUNNY BAG OF 500 NOS. EACH	
2	18700024	BOLT, HEX, M12*70L THD 30L, MS GR 4.6, IS 4218 ,IS 1367, BS 3692/1967, THRDS ISO METRIC CLASS 6g TO CAD PLATEDMDS 2024-03, PACKED IN GUNNY BAG OF 500 NOS EACH	
3	18700030	BOLT, HEX, M16*75L, MS GR 4.6, IS 4218, IS 1367, BS 3692/1967, THRDS ISO METRIC CLASS 6g TOCAD PLATED, PACKED IN GUNNY BAG OF 500 NOS EACH	
4	18701579	NUT PRECISION, HEX, M12, STEEL 4 (MS), ZINC PLATED, IS-1364 CONFORMING TO IS-1367, THREADS ISO METRIC CORES MEDIUM (6H/6g),TO IS-4218, PACKED IN GUNNY BAG OF 1000 NOS EACH	
5	18701580	NUT PRECISION, HEX, M16, STEEL 4 (MS), ZINC PLATED, IS-1364 CONFORMING TO IS-1367, THREADS ISO METRIC CORES MEDIUM (6H/6g),TO IS-4218, PACKED IN GUNNY BAG OF 1000 NOS EACH	
6	18701581	NUT PRECISION, HEX, M20, STEEL 4 (MS), ZINC PLATED, IS-1364 CONFORMING TO IS-1367, THREADS ISO METRIC CORES MEDIUM (6H/6g),TO IS-4218, PACKED IN GUNNY BAG OF 1000 NOS EACH	
7	18703716	WASHER SPRING, MS ZINC PLATED, IS 3063/1972, (FOR M12 BOLT), PACKED IN CARDBOARD BOX/POLYTHENE BAG OF 100 NOS. EACH.	
8	18701961	BOLT, M6*30, CUP HEAD, SQUARE NECK COMPLETE WITH WASHER, NUT AND CHECK NUT, DRG.NO. 349108, STEEL 4.8 TO IS 2609, HOT DIP /ELECTRO GALVANISED	
9	18701991	BOLT, HEX, M16*80L BOLT, HEX, M16*80L, MS GR 4.6, IS 4218 ,IS 1367, BS 3692/1967, THRDS ISO METRIC CLASS 6g TOCAD PLATED, PACKED IN GUNNY BAG OF 500NOS EACH	
10	18701992	BOLT, HEX, M16*90L BOLT, HEX, M16*90L, MS GR 4.6, IS 4218 ,IS 1367, BS 3692/1967, THRDS ISO METRIC CLASS 6g TOCAD PLATED, PACKED IN GUNNY BAG OF 500NOS EACH	
11	18701993	BOLT, HEX, M20*90L BOLT, HEX.HD.4.6 (MS), M20*90, IS-1367, BS 3692/1967, THRDS ISO METRICCLASS 6g TO IS 4218 CAD PLATED, PACKED IN GUNNY BAG OF 500 NOS. EACH	
12	18701994	BOLT, HEX, M20*100L BOLT, HEX.HD.4.6 (MS), M20*100, IS-1367, BS 3692/1967, THRDS ISO METRICCLASS 6g TO IS 4218 CAD PLATED, PACKED IN GUNNY BAG OF 500 NOS. EACH	
13	18701995	BOLT, HEX, M20*110L BOLT, HEX.HD.4.6 (MS), M20*110, IS-1367, BS 3692/1967, THRDS ISO METRICCLASS 6g TO IS 4218 CAD PLATED, PACKED IN GUNNY BAG OF 500 NOS. EACH	



## Mazagon Dock Shipbuilders Limited, Mumbai

14	18701996	BOLT, HEX, M20*120L BOLT, HEX.HD.4.6 (MS), M20*120, IS-1367, BS 3692/1967, THRDS ISO METRICCLASS 6g TO IS 4218 CAD PLATED, PACKED IN GUNNY BAG OF 500 NOS. EACH	
15	18701997	BOLT, HEX, M24*110L BOLT, HEX.HD.4.6 (MS), M24*110, IS-1367, THRDS ISO METRIC CLASS 6g TO IS4218, CAD PLATED, BS-3692, PACKED IN GUNNY BAG OF 500 NOS. EACH	
16	18701998	BOLT, HEX, M24*130L BOLT, HEX.HD.4.6 (MS), M24*130, IS-1367, THRDS ISO METRIC CLASS 6g TO IS4218, CAD PLATED, BS-3692, PACKED IN GUNNY BAG OF 500 NOS. EACH	
17	18701999	BOLT, HEX, M24*150L BOLT, HEX.HD.4.6 (MS), M24*150, IS-1367, THRDS ISO METRIC CLASS 6g TO IS4218, CAD PLATED, BS-3692, PACKED IN GUNNY BAG OF 500 NOS. EACH	
18	18701589	NUT PRECISION, HEX, M24 NUT PRECISION, HEX, M24, STEEL 4 (MS), ZINC PLATED, IS-1364 CONFORMINGTO IS-1367, THREADS ISO METRIC CORES MEDIUM (6H/6g),TOIS-4218, PACKED IN GUNNY BAG OF 1000 NOS EACH	
19	18703225	WASHER SPR, MS ZINC PLATE, M16 WASHER SPRING, MS ZINC PLATED, IS 3063/1972, (FOR M16 BOLT), PACKED IN CARDBOARD BOX / POLYTHENE BAG OF 100 NOS. EACH.	
20	18703226	WASHER SPR, MS ZINC PLATE, M20 WASHER SPRING, MS ZINC PLATED, IS 3063/1972, (FOR M20 BOLT), PACKED IN CARDBOARD BOX / POLYTHENE BAG OF 100 NOS. EACH.	
21	18703227	WASHER SPR, MS ZINC PLATE, M24 WASHER SPRING, MS ZINC PLATED, IS 3063/1972, (FOR M24 BOLT), PACKED IN CARDBOARD BOX / POLYTHENE BAG OF 100 NOS. EACH.	
22	18703228	WASHER PLATE, M12 WASHER PLAIN, FOR M12 BOLT, MS ZINC PLATED, IS 2016, PACKED IN CARDBOARD BOX / POLYTHENE BAG OF 100 NOS. EACH.	
23	18703229	WASHER PLATE, M16 WASHER PLAIN, FOR M16 BOLT, MS ZINC PLATED, IS 2016, PACKED IN CARDBOARD BOX / POLYTHENE BAG OF 100 NOS. EACH.	
24	18703230	WASHER PLATE, M20 WASHER PLAIN, FOR M20 BOLT, MS ZINC PLATED, IS 2016, PACKED IN CARDBOARD BOX / POLYTHENE BAG OF 100 NOS. EACH.	
25	18703231	WASHER PLATE, M24 WASHER PLAIN, FOR M24 BOLT, MS ZINC PLATED, IS 2016, PACKED IN CARDBOARD BOX / POLYTHENE BAG OF 100 NOS. EACH.	
26	18701962	BOLT, M6*20, MUSHROOM HEAD COMPLETE WITH WASHER, SPING WASHER WITH HEX. NUT, HOT DIP/ELECTRIC GALVANISED AS PER IS 1367 GRADE 4.8	
27	18701578	NUT, PRECISION, HEX, M10, STEEL 4 (MS), ZINC PLATED TO SPECN. IS-1364 CONFORMING TO IS:1367, THREADS ISO METRIC CORES MEDIUM (6H/6g), TO IS- 4218, PACKED IN POLYTHENE BAG OF 1000 NOS. EACH.	
28	18703111	WASHER FLAT, 10.5 ID*21.0 OD*1.8-2.2 THK, MS, IS-2016, (BS-1449), FOR M10 BOLT. ELECTRO PLATEDMDS 2024-72, PACKED IN GUNNY BAG OF 500 NOS EACH	
29	18703221	WASHER SPRING, MS, 10.5 ID*16.0 OD*1.8-2.2 THK, IS 3063/1972, FOR M10m BOLT, ELECTRO PLATED, MDS, PACKED IN GUNNY BAG OF 500 NOS EACH.	
30	18707426	SCREW, CSK, 6MM DIA*25L PITCH, MS ZINC PLATED, BS 4183 DGS 326 PART2 EQUIV. STD MDL DRG NO 2024-19	



## Mazagon Dock Shipbuilders Limited, Mumbai

31	18703041	WASHER, M6, MS ZINC PLATED, EQUIV STD DGS 326 STEEL BS 1449 BS 1706 ZN3	
32	18701576	NUT, PRECISION, HEX, M6, STEEL 4 (MS), ZINC PLATED, IS-1364 CONFORMING TO IS-1367, THREADS ISO METRIC CORES MEDIUM (6H/6g), TO IS-4218, PACKED IN GUNNY BAG OF 1000 NOS EACH.	
33	18703211	WASHER SPRING, M6, MS ZINC PLATED, IS 6735, SQUARE BASE	

**Note:**

1. As per Serial no. xiii (m) (i) of Para 4 of General Terms and Conditions on GeM, EMD exemption is applicable for those offered items of which the MSE bidder is a manufacturer. For the remaining products/items, MSE bidder shall not be eligible for exemption of EMD.
2. Above confirmation shall be duly filled (Yes or No) for each item by the bidder and it shall be uploaded along with the Part 1 bid.
3. Each page to be duly signed with stamp by bidder's authorized representative.

Signature & Stamp of Authorized Person



**Official Secret Act 1923**

*(ILLUSTRATIVE FORMAT)*

**SECTION 2(B) : “PROHIBITED PLACE”**

It is defined as the place of any work of Defence Dockyard and other so belonging or occupied and used for the purpose of building, repairing, making or storing any ammunitions of war.

For the purpose of the above definition, sketch includes any photograph or other mode of representing any place or thing.

**SECTION 3 : “PENALTIES FOR SPYING”**

If any per unlawfully -

- a) approaches, inspects, passes over or is in the vicinity of any clear place; or
- b) make any sketches intended to be directly or indirectly useful to an enemy ; or
- c) obtains, collects, records or communicates to any other person any secret official code.

Shall be liable for imprisonment of 14 years in case of Defence Installation.

**SECTION 4 : “COMMUNICATION WITH FOREIGN AGENTS”**

If Any person has been in communication with or attempted to communicate with foreign agents regarding the vital information of any “PROHIBITED PLACE” would be guilty of violating the provisions of this Act.

**SECTION 5 : “WRONGFUL COMMUNICATION OF INFORMATION”**

If any person having in his possession or control any official document;

- a) Willfully communicates to any person, other than a person, who is authorised to communicate it.
- b) Used the information in his possession for the benefit of any foreign power.
- c) Retain in his possession when he has no power to retain it
- d) Fails to take reasonable care of it.

Shall be guilty of an offence under this Act.

**SECTION 6 : “UNAUTHORISED USE OF UNIFORMS”**

If any person for the purpose of gaining admission or of assisting any other person to gain admission to a “PROHIBITED PLACE” wears uniforms without lawful authority shall be guilty of offence under this Section.

**SECTION 7 : “INTERFERING WITH OFFICERS OF POLICE”**

No person in the vicinity of any “PROHIBITED PLACE” shall abstract any Police Officer engaged on guard, sentry or similar duty. If any person move in the provisions of this section, shall be punishable with imprisonment, which may extend up to 3 years.

**SECTION 8 : “DUTY OF GIVING INFORMATION”**

It shall be duty of every person to give on demand to a superintendent of Police or any other Police Officer not below the rank of Inspector, any information in his power relating to an offence under this Act.

If any person fails to give such information, shall be punishable with imprisonment to 3 years or fine or with both.

**SECTION 9 : “INCITEMENT”**

Any person who attempts to commit or debate the commission of an offence under this Act shall be punishable with the same punishment and be liable to be proceeded against in the same manner as if he had committed such offence.

**SECTION 10 : “PENALTY FOR HARBOURING SPIES”**

If any person whom he knows or has reasonable grounds for supposing to be person who is about to commit or who has committed offence under this Act shall be guilty of offence under this Section.

**SECTION 11 : “SEARCH WARRANTS”**

If a presidency Magistrate, Magistrate First Class or Sub-Divisional magistrate is satisfied with the information that there is reasonable ground for suspecting that an offence under this Act has been or is about to be committed, he may grant search warrant to any Police Officer to enter at any time any premises to force to search premises or the places.



Enclosure-5

Drawing for tender item no 08 (Material Code no. 18701961)

MAZDOCK  
STANDARD

TITLE CONNECTING PIECE AND  
VERTICAL SUPPORT FOR HANGER

3491108

REV

DATE  
1990/03/29

SHEET  
5/6

ALL DIMENSIONS IN mm.  
ALL WEIGHTS IN kg.

EQUIV STANDARDS EL-87/ 9A

INTENDED USE:

CONNECTING PIECE

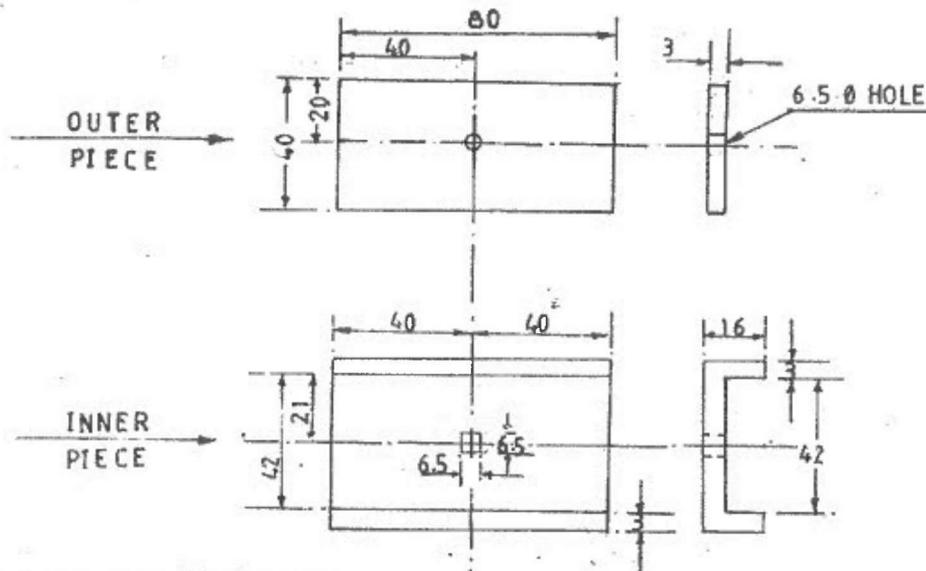

MATERIAL CODE NO 12014195

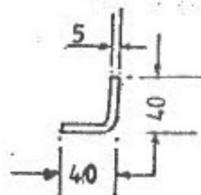
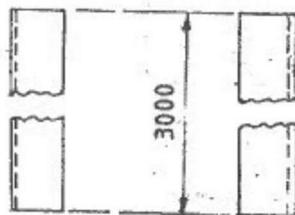

VERTICAL SUPPORT

MATERIAL: MILD STEEL IS 2062  
FINISH: HOT DIP GALVANISED 50 μ  
MATERIAL CODE NO 12014196

CUPHEAD SQUARE NECK BOLT  
COMPLETE WITH WASHER, NUT  
AND CHECK NUT.

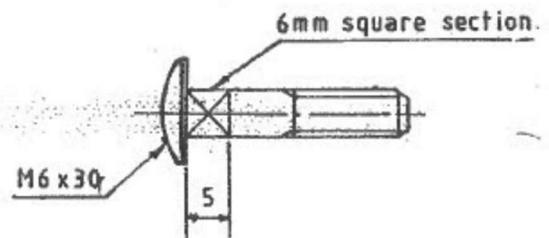

MATERIAL:- Steel 4.8 to IS 2609.  
FINISH - HOT DIP/ELECTRO GALVANISED  
MATERIAL CODE NO 12701361



Enclosure-6

Drawing for tender item no 30 (Material Code no. 18707426)

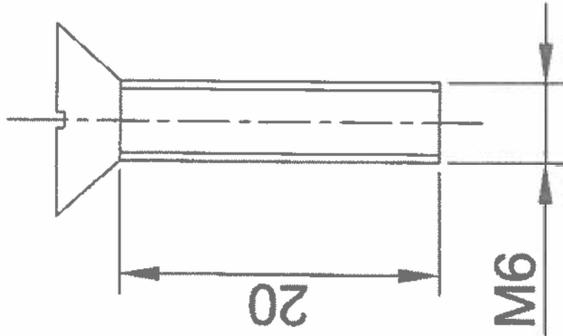

M6X20  
SCREW

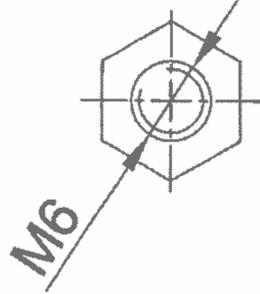

M6  
HEXAGONAL NUT

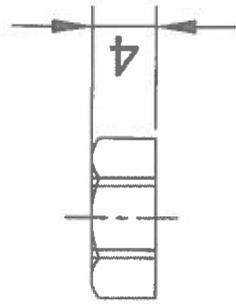

PLAIN  
WASHER

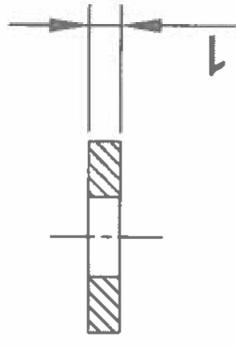
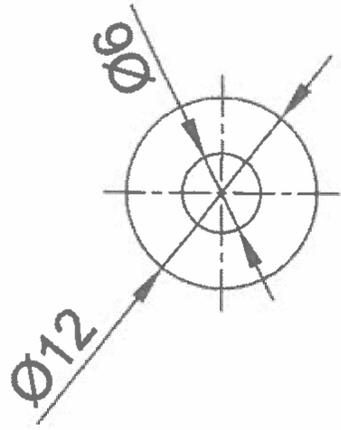

SPRING  
WASHER

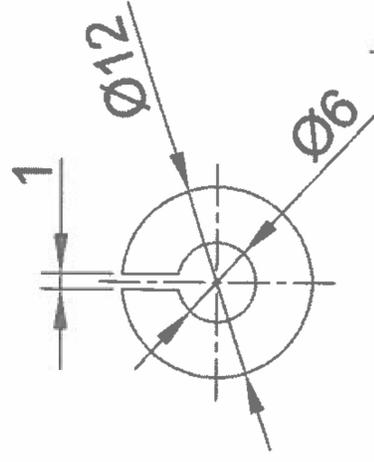

NOTE:-

1. ALL DIMENSIONS ARE IN MM.
2. MATERIAL M.S. ZINC PLATED.

MATERIAL NO. :- 18707426



Approved  
  
 सुधीर सोनावणे  
 SUDHIR SONAWANE  
 सुधीर सोनावणे (सुधीर सोनावणे व्हा. सोवणे)  
 सुधीर सोनावणे (DESIGN-ELECTRICAL & WEAPON)  
 सुधीर सोनावणे (DESIGN-ELECTRICAL & WEAPON) LIMITED