

## **Corrigendum-4**

- i) This corrigendum is being issued due to the following amendments in the tender.
- ii) The amendments are highlighted in the red.
- iii) Commercial PQC, EMD values updated.
- iv) Integrity Pact is made applicable.
- v) Bidders have to quote as per this corrigendum only.
- vi) Bidders who have already submitted their bids have to revise their offers as per this corrigendum.
- vii) Offers not in line with this corrigendum will not be evaluated.

### **3. Pre-Qualification Criteria(PQC):**

#### **(b) Commercial PQC:**

- i. The average annual financial turnover of 'The bidder' during the last three years, ending 31st March (or any other year ending followed in relevant country) of the previous financial year excluding the calendar year of tendering should be at **INR 1,05,00,000/-** as per the annual report (audited balance sheet and profit and loss account) of the relevant period, duly authenticated by a Chartered Accountant/Cost Accountant in India or equivalent in relevant countries.

### **4. Earnest Money Deposit (EMD) / Bid Security: INR 7,00,000/-**

### **35. Integrity Pact: Made Applicable**

- i) The bidder has to submit Integrity Pact as per the attached format in the enclosure.
- ii) Each page of Integrity pact shall be duly signed by the bidder. Non-submission of Integrity pact by the bidders duly signed on each page along with Part-I bid shall be liable for rejection.
- iii) In case of issues related to Integrity Pact (IP) please contact Independent External Monitor (IEM) whose details are as below:

#### **a) Mr. P V Rao**

Email id: [pasupuletirao@yahoo.co.in](mailto:pasupuletirao@yahoo.co.in)

**Enclosure 9: Format for Integrity Pact**

**INTEGRITY PACT**

**Mazagon Dock Shipbuilders Limited (MDL)** hereinafter referred to as "**The Principal/Buyer**"

And

.....hereinafter referred to as "**The Bidder/ Contractor**"

**Preamble**

The Principal/Buyer intends to award, under laid down organizational procedures, contract/s for .....The Principal/Buyer values full compliance with all relevant laws of the land, rules, regulations, economic use of resources and of fairness / transparency in its relations with its Bidder(s) and /or Contractor(s).

In order to achieve these goals, the Principal/Buyer will appoint an Independent External Monitor (IEM), who will monitor the tender process and the execution of the contract for compliance with the principles mentioned above.

**Section 1 - Commitments of the Principal/Buyer:**

(1) The Principal/Buyer commits itself to take all measures necessary to prevent corruption and to observe the following principles:

a) No employee of the Principal/Buyer, personally or through family members, will in connection with the tender for, or the execution of a contract, demand, take a promise for or accept, for self or third person, any material or immaterial benefit which the person is not legally entitled to.

b) The Principal/Buyer will during the tender process treat all Bidder(s) with equity and reason. The Principal/Buyer will in particular, before and during the tender process, provide to all Bidder(s) the same information and will not provide to any Bidder(s) confidential/additional information through which the Bidder(s) could obtain an advantage in relation to the tender process or the contract execution.

c) The Principal/Buyer will exclude from the process all known prejudiced persons.

d) The Principal/Buyer undertakes to scrupulously follow the Purchase Manual containing Standard Terms & Conditions (STAC) and General Terms & Conditions (GT&C) in respect of procurement contracts for goods, services and civil works.

(1) If the Principal/Buyer obtains information on the conduct of any of its employees which is a criminal offence under the relevant Anti-Corruption Laws of India, or if there be a substantive suspicion in this regard, the Principal/Buyer will inform the Chief Vigilance Officer, MDL and in addition can initiate disciplinary actions.

**Section 2 - Commitments of the Bidder(s)/Contractor(s):**

(1) The Bidder(s)/Contractor(s) commit himself to take all measures necessary to prevent corruption. He commits himself to observe the following principles during his participation in the tender process and during the contract execution.

*Bidder's Sign*.....

*Bidder's Stamp*.....

a) The Bidder(s)/Contractor(s) will not, directly or through any other persons or firm, offer promise or give to any of the Principal/Buyer's employees involved in the tender process or the execution of the contract or to any third person any material or other benefit which he/she is not legally entitled to, in order to obtain in exchange any advantage or any kind whatsoever during the tender process or during the execution of the contract.

b) The Bidder(s)/Contractor(s) will not enter with other Bidders into any undisclosed agreement or understanding, whether formal or informal. This applies in particular to prices, specifications, certifications, subsidiary contracts, submission or non-submission of bids or any other actions to restrict competitiveness or to introduce cartelization in the bidding process.

c) The Bidder(s)/Contractor(s) will not commit any offence under the relevant Anti-Corruption Laws of India; further the Bidder(s)/Contractor(s) will not use improperly, for purposes of competition or personal gain, or pass on to other, any information or document provided by the Principal/Buyer as part of the business relationship, regarding plans, technical proposals and business details, including information contained or transmitted electronically.

d) The Bidder(s)/Contractor(s) of foreign origin shall disclose the name and address of the Agents/representatives in India, if any. Similarly, the Bidder(s)/Contractor(s) of Indian Nationality shall furnish the name and address of the foreign principals, if any. All payments made to the Indian Agent/representative have to be in Indian Rupees only. Further details as mentioned in the "Guidelines of Indian Agents of Foreign suppliers" shall be disclosed by the Bidders(s)/Contractor(s). Copy of the "Guidelines on Indian Agents of Foreign Suppliers" as annexed and marked as Annexure-A.

e) The Bidder(s)/Contractor(s) will when presenting his bid, disclose any and all payments he has made, is committed to or intends to make to agents, brokers or any other intermediaries in connection with the award of the contract.

f) The Bidder (s)/Contractor(s), their agents, representatives shall not do such things so as to interfere with the procedures laid down in the Principal/Buyer's Purchase Manual containing the Standard Terms and Conditions (STAC) and General Terms and Conditions (GT&C) in respect of procurement contracts for goods, services and civil works.

g) The Bidder commits to refrain from giving any complaint directly or through any other manner without supporting it with full and verifiable facts.

(2) The Bidder(s)/Contractor(s) will not instigate third persons to commit offences outlines above or be an accessory to such offences.

**Section 3 - Disqualification from tender process and exclusion from future contracts:**

If the Bidder(s)/Contractor(s) before contract award has committed a transgression through a violation of Section 2, above or in any other form such as to put his reliability or credibility as Bidder(s) in question, the Principal/Buyer is entitled to disqualify the Bidder(s)/Contractor(s) from the tender process or to terminate the contract, if already signed for such reason, as per the procedure mentioned in the "Guidelines on Banning of business dealings" Copy of the "Guidelines on Banning of business dealings" is annexed and marked as Annexure-B.

*Bidder's Sign*.....

*Bidder's Stamp*.....

1) If the Bidder(s)/Contractor(s) has committed a transgression through a violation of Section 2 such as to put his reliability or credibility into question, the Principal/Buyer is entitled also to exclude the Bidder(s)/Contractor(s) from future contract award processes. The imposition and duration of the exclusion will be determined by the severity of the transgression. The severity will be determined by the circumstances of the case, in particular the number of transgressions, the position of the transgressors within the company hierarchy of the Bidder(s) and the amount of the damage. The exclusion will be imposed for a minimum of six months and maximum of five years, which may be further extended at the discretion of the Principal/Buyer.

2) A transgression is considered to have occurred, if the Principal/Buyer after due consideration of the available evidence, concludes that no reasonable doubt is possible.

3) The Bidder (s) accepts and undertakes to respect and uphold the Principal/Buyer's absolute right to resort to and impose such exclusion and further accepts and undertakes not to challenge or question such exclusion on any ground, including the lack of any hearing before the decision to resort to such exclusion is taken. This undertaking is given freely and after obtaining legal advice.

4) If the Bidder(s)/Contractor(s) can prove that he has restored/ recouped the damage caused by him and has installed a suitable corruption prevention system, the Principal/Buyer may revoke the exclusion prematurely.

#### **Section 4 – Sanctions for Violation:**

(1) Any breach of the aforesaid provisions by the Bidder or any one employed by him or acting on his behalf (whether with or without the knowledge of the Bidder) or the commission of any offence by the Bidder or any one employed by him or acting on his behalf, as defined in Chapter IX of the Indian Penal Code, 1860 or the Prevention of Corruption Act 1988 or any other Act enacted for the prevention of corruption shall entitle the Principal/Buyer to take all or any one of the following actions, wherever required –

a) To immediately call off the pre-contract negotiations without assigning any reason or giving any compensation to the Bidder. However, the proceedings with the other Bidder (s) would continue.

b) The Earnest Money Deposit/Security Deposit/Performance Bond shall stand forfeited either fully or partially, as decided by the Principal/Buyer, and the Principal/Buyer shall not be required to assign any reason there for.

c) To immediately cancel the contract, if already signed, without giving any compensation to the Bidder.

d) To recover all sums already paid by the Principal/Buyer, in case of an Indian Bidder with interest thereon at 2% higher than the prevailing Base Rate of SBI, and in case of a Bidder from a country other than India with interest thereon at 2% higher than the LIBOR. If any outstanding payment is due to the Bidder from the Buyer in connection with any other contract for any other Defence stores, such outstanding payment could also be utilized to recover the aforesaid sum and interest.

e) To encash the advance Bank Guarantee and Performance Bond/Warranty bond, if furnished by the Bidder, in order to recover the payments, already made by the Principal/Buyer, along with interest.

f) To cancel all or any other contracts with the Bidder.

g) To debar the Bidder from entering into any bid from Principal/Buyer for a minimum period of five years, which may be further extended at the discretion of the Principal/Buyer.

*Bidder's Sign*.....

*Bidder's Stamp*.....



h) To recover all sums paid in violation of this Pact by Bidder(s) to any middleman or agent or broker with a view to securing the contract.

i) If the Bidder or any employee of the Bidder or any person acting on behalf of the Bidder, either directly or indirectly, is closely related to any of the officers of the Buyer, or alternatively, if any close relative of an officer of the Buyer has financial interest/stake in the Bidder’s firm, the same shall be disclosed by the Bidder at the time of filing of tender. Any failure to disclose the interest involved shall entitle the Buyer to rescind the contract without payment of any compensation to the Bidder.

The term ‘close relative’ for this purpose would mean spouse whether residing with the Principal/Buyer’s employee/employees or not, but not include a spouse separated from the Principal/Buyer’s employee/employees by a decree or order of a competent court; son or daughter or step son or step daughter and wholly dependent upon Principal/Buyer’s employee/employees, but does not include a child or step child who is no longer in any way dependent upon the Principal/Buyer’s employee/employees or of whose custody the Principal/Buyer’s employee/employees has been deprived of by or under any law; any other person related, whether by blood or marriage, to the Principal/Buyer’s employee/employees or to the Principal/Buyer’s employee/employees wife or husband and wholly dependent upon Principal/Buyer’s employee/employees.

j) The Bidder shall not lend to or borrow any money from or enter into any monetary dealings or transactions, directly or indirectly, with any employee of the Principal/Buyer, and if he does so, the Principal/Buyer shall be entitled forthwith to rescind the contract and all other contracts with the Bidder. The Bidder shall be liable to pay compensation for any loss or damage to the Principal/Buyer resulting from such rescission and the Principal/Buyer shall be entitled to deduct the amount so payable from the money(s) due to the Bidder.

k) In cases where Irrevocable Letters of Credit have been received in respect of any contract signed by the Principal/Buyer with the Bidder, the same shall not be opened.

(2) The decision of the Principal/Buyer to the effect that a breach of the provisions of this Integrity Pact has been committed by the Bidder shall be final and binding on the Bidder, however, the same Bidder can approach the Monitor(s) appointed for the purposes of this Pact.

**Section 5 - Integrity Pact:**

1) The provisions regarding Sanctions for violation of Integrity Pact include forfeiture of Performance Bond in case of a decision by the Principal/Buyer to forfeit the same without assigning any reason for imposing sanction for violation of Integrity Pact.

2) No interest shall be payable by the Principal/Buyer to the Bidder(s) on Earnest Money/Security Deposit for the period of its currency.

**Section 6 - Previous Transgression:**

(1) The Bidder declares that no previous transgressions occurred in the last three years with any other company in any country conforming to the anti-corruption approach or with any other public section enterprise in India that could justify his exclusion from the tender process.

(2) If the bidder makes incorrect statement on this subject, he can be disqualified from the tender process or further action can be taken.

*Bidder’s Sign*.....

*Bidder’s Stamp*.....

**Section 7 - Equal treatment of all Bidders/Contractor(s)/Subcontractors:**

- (1) The Bidder(s)/Contractor(s) undertake(s) to demand from all subcontractors a commitment in conformity with this integrity Pact, and to submit it to the Principal before contract signing.
- (2) The Principal/Buyer will enter into agreements with identical conditions as this one with all bidders, contractors and subcontractors.
- (3) The Principal/Buyer will disqualify from the tender process all bidders who do not sign this Pact or violate its provisions.

**Section 8 - Criminal charges against violation Bidder(s)/Contractor(s)/ Subcontractor(s):**

- (1) If the Principal/Buyer obtains knowledge of conduct of a Bidder, Contractor or subcontractor, or of an employee or a representative or an associate of a Bidder, Contractor of subcontractor which constitutes corruption or if the Principal has substantive suspicion in this regard, the Principal/Buyer will inform the same to the Chief Vigilance Officer, MDL.

**Section 9 - Independent External Monitor/Monitors:**

- (1) The Principal/Buyer appoints competent and credible independent External Monitor for this Pact. The task of the Monitor is to review independently and objectively whether and to what extent the parties comply with the obligations under this agreement.
- (2) The Monitor is not subject to instructions by the representatives of the parties and performs his functions neutrally and independently. He reports to the Chairman & Managing Director of the Principal/Buyer.
- (3) The Bidder(s)/Contractor(s) accepts that the Monitor has the right to access without restriction to all project documentation of the Principal/Buyer including that provided by the Contractor. The Contractor will also grant the Monitor, upon his request and demonstration of a valid interest, unrestricted and unconditional access to his project documentation. The same is applicable to Subcontractors. The Monitor is under contractual obligation to treat the information and documents of the Bidder(s)/Contractor(s)/Subcontractor(s) with confidentiality.
- (4) The Principal/Buyer will provide to the Monitor sufficient information about all meetings among the parties related to the Project provided such meetings could have an impact on the contractual relations, between the Principal/Buyer and the Contractor. The parties offer to the Monitor the option to participate in such meetings.
- (5) As soon as the Monitor notices, or believes to notice, a violation of this agreement, he will so inform the Management of the Principal/Buyer and request the Management to discontinue or take corrective action, or to take other relevant action. The Monitor can in this regard submit non-binding recommendations. Beyond this, the Monitor has no right to demand from the parties that they act in a specific manner, refrain from action or tolerate action. However, the Monitor shall give an opportunity to the Bidder(s)/Contractor(s) to present its case before making its recommendation to the Principal/Buyer.
- (6) The Monitor will submit a written report to the Chairman & Managing Director of the Principal within 8 to 10 weeks from the date of reference or intimation to him by the Principal/Buyer and, should the occasion arise, submit proposals for correcting problematic situations.
- (7) Monitor shall be entitled to compensation on the same terms as being extended to / provided to Independent Directors on the Board of Principal/Buyer.

*Bidder's Sign.....*

*Bidder's Stamp.....*

(8) If the Monitor has reported to the Chairman & Managing Director of the Principal, a substantiated suspicion of an offence under relevant Anti-Corruption Laws of India and the Chairman & Managing Director of the Principal/Buyer has not, within the reasonable time taken visible action to proceed against such offence or reported it to the Chief Vigilance Officer, the Monitor may also transmit this information directly to the Central Vigilance Commissioner, Government of India.

(9) The word 'Monitor' would include both singular and plural.

**Section 10 - Pact Duration:**

This pact begins when both parties have legally signed it. It expires for the Contractor 12 months after the last payment under the contract and for all other Bidders 06 months after the contract has been awarded. If any claim is made / lodged during this time, the same shall be binding and continue to be valid despite the lapse of this pact as specified above unless it is discharged / determined by Chairman & Managing Director of the Principal/Buyer.

**Section 11 - Other provisions:**

(1) This agreement is subject to Indian Law, place of performance and jurisdiction is the Registered Office of the Principal/Buyer, i.e. Mumbai. The Arbitration clauses provided in the main tender document/ contract shall not be applicable for any issue/dispute arising under this Integrity pact.

(2) Changes and supplements as well as termination notices need to be made in writing. Side agreements have not been made.

(3) If the Contractor is a partnership or a consortium, this agreement must be signed by all partners or consortium members.

(4) Should one or several provisions of this agreement turn out to be invalid, the remainder of this agreement remains valid. In this case, the parties will strive to come to an agreement to their original intentions.

**Section 12 – Fall Clause: #**

“The Bidder undertakes that it has not supplied/is not supplying similar products/ systems or subsystems at a price lower than that offered in the present bid in respect of any other Ministry/Department of the Government of India or PSU and if it is found at any stage that similar product/systems or sub systems was supplied by the Bidder to any other Ministry/Department of the Government of India or a PSU at a lower price, then that very price, with due allowance of elapsed time, will be applicable to the present case and the difference in the cost would be refunded by the Bidder to the Principal/Buyer, if the contract has already been concluded.”

\_\_\_\_\_

For & on behalf of

MAZAGON DOCK Shipbuilders LIMITED for & on behalf of Bidder/Contractor

(Office Seal) (Office Seal)

Place\_\_\_\_\_

Date\_\_\_\_\_

Witness 1:

(Name & Address)

\_\_\_\_\_  
\_\_\_\_\_  
\_\_\_\_\_

Witness 2:

(Name & Address)

\_\_\_\_\_  
\_\_\_\_\_  
\_\_\_\_\_

**Annexure-A****GUIDELINES FOR INDIAN AGENTS OF FOREIGN SUPPLIERS**

1.0 There shall be compulsory registration of agents for all Global (Open) Tender and Limited Tender. An agent who is not registered with MDL shall apply for registration.

1.1 An agent shall represent only one Foreign Supplier and not represent two suppliers or quote on their behalf in the same tender. However, either the Indian Agent on behalf of the Foreign Suppliers (also includes foreign manufacturers) or the Foreign Suppliers (also includes foreign manufacturers) directly could bid in a tender, but not both. In cases where an agent participates in a tender on behalf of one manufacturer, shall not quote on behalf of another manufacturer along with the first Manufacturer in a subsequent/parallel tender for the same item.

1.2 Registered agents will file an authenticated Photostat copy duly attested by a Notary Public/Original certificate of the principal confirming the agency agreement and giving the status being enjoyed by the agent and the commission/remuneration/salary/ retainer ship being paid by the principal to the agent before the placement of order by MDL.

1.3 Wherever the Indian representatives have communicated on behalf of their principals and the foreign parties have stated that they are not paying any commission to the Indian agents, and the Indian representative is working on the basis of salary or as retainer, a written declaration to this effect should be submitted by the party (i.e. Principal) before finalizing the order.

**2.0 DISCLOSURE OF PARTICULARS OF AGENTS/ REPRESENTATIVES IN INDIA, IF ANY.**

2.1 Tenderers of Foreign nationality shall furnish the following details in their offer:

2.1.1 The name and address of the agents/representatives in India, if any and the extent of authorization and authority given to commit the Principals. In case the agent/representative be a foreign Company, it shall be confirmed whether it is real substantial Company and details of the same shall be furnished.

2.1.2 The amount of commission/remuneration included in the quoted price(s) for such agents/representatives in India.

2.1.3 Confirmation of the Tenderer that the commission/ remuneration if any, payable to his agents/ representatives in India, may be paid by MDL in Indian Rupees only.

2.2 Tenderers of Indian Nationality shall furnish the following details in their offers:

2.2.1 The name and address of the foreign principals indicating their nationality as well as their status, i.e, whether manufacturer or agents of manufacturer holding the Letter of Authority of the Principal

specifically authorizing the agent to make an offer in India in response to tender either directly or through the agents/representatives.

2.2.2 The amount of commission/remuneration included in the price (s) quoted by the Tenderer for himself.

2.2.3 Confirmation of the foreign principals of the Tenderer that the commission/remuneration, if any, reserved for the Tenderer in the quoted price (s), may be paid by MDL in India in equivalent Indian Rupees on satisfactory completion of the Project or supplies of Stores and Spares in case of operation items

2.3 In either case, in the event of contract materializing, the terms of payment will provide for payment of the commission /remuneration, if any payable to the agents/representatives in India in Indian Rupees on expiry of 90 days after the discharge of the obligations under the contract.

2.4 Failure to furnish correct and detailed information as called for in paragraph-2.0 above will render the concerned tender liable to rejection or in the event of a contract materializing, the same liable to termination by MDL. Besides this there would be a penalty of banning business dealings with MDL or damage or payment of a named sum. \_\_\_\_\_

**Annexure-B****GUIDELINES ON BANNING OF BUSINESS DEALINGS****CONTENTS**

| <b>Sr.</b> | <b>Description</b>  | <b>Pages</b> |
|------------|---|--------------|
| 1.         | Introduction  | 2            |
| 2.         | Scope   | 2            |
| 3.         | Definitions   | 2 - 3        |
| 4.         | Initiation of Banning / Suspension  | 3            |
| 5.         | Suspension of Business Dealings   | 3 - 4        |
| 6.         | Ground on which Banning of Business Dealing can be initiated                      | 4 - 5        |
| 7.         | Banning of Business Dealings  | 5-6          |
| 8.         | Removal from List of Approved Agencies-Suppliers/ Contractors etc.                | 6            |
| 9.         | Procedure for issuing Show-cause Notice   | 6            |
| 10.        | Appeal against the Decision of the Competent Authority                            | 7            |
| 11.        | Review of the Decision by the Competent Authority                                 | 7            |
| 12.        | Circulation of the names of Agencies with whom Business Dealings have been banned | 7            |

**1. Introduction**

1.1 Mazagon Dock Shipbuilders Limited (MDL), being a Public Sector Enterprise and 'State', within the meaning of Article 12 of Constitution of India, has to ensure preservation of rights enshrined in Chapter III of the Constitution. MDL as also to safeguard its commercial interests. MDL deals with Agencies, who have a very high degree of integrity, commitments and sincerity towards the work undertaken. It is not in the interest of MDL to deal with Agencies who commit deception, fraud or other misconduct in the execution of contracts awarded / orders issued to them. In order to ensure compliance with the constitutional mandate, it is incumbent on MDL to observe principles of natural justice before banning the business dealings with any Agency.

1.2 Since banning of business dealings involves civil consequences for an Agency concerned, it is incumbent that adequate opportunity of hearing is provided and the explanation, if tendered, is considered before passing any order in this regard keeping in view the facts and circumstances of the case.

**2. Scope**

2.1 MDL reserves its rights to remove from list of approved suppliers / contractors or to ban business dealings if any Agency has been found to have committed misconduct and also to suspend business dealings pending investigation.

2.2 Similarly, in case of sale of material there is a clause to deal with the Agencies / customers / buyers, who indulge in lifting of material in unauthorized manner.

2.3 However, absence of such a clause does not in any way restrict the right of MDL to take action / decision under these guidelines in appropriate cases.

2.4 The procedure of (i) Removal of Agency from the List of approved suppliers / contractors; (ii) Suspension and (iii) Banning of Business Dealing with Agencies, has been laid down in these guidelines.

2.5 These guidelines apply to all the Divisions/Yards of MDL.

2.6 It is clarified that these guidelines do not deal with the decision of the Management not to entertain any particular Agency due to its poor / inadequate performance or for any other reason.

2.7 The banning shall be with prospective effect, i.e., future business dealings.

### 3. Definitions

In these Guidelines, unless the context otherwise requires:

- i) 'Bidder / Contractor / Supplier / Purchaser / Customer' shall mean and include a public limited company or a private limited company, a firm whether registered or not, an individual, a cooperative society or an association or a group of persons engaged in any commerce, trade, industry, etc. 'Bidder / Contractor / Supplier / Purchaser / Customer' in the context of these guidelines is indicated as 'Agency'.
- ii) 'Inter-connected Agency' shall mean two or more companies having any of the following features:
  - a) If one is a subsidiary of the other.
  - b) If the Director(s), Partner(s), Manager(s) or Representative(s) are common;
  - c) If management is common;
  - d) If one owns or controls the other in any manner;
- iii) 'Competent Authority' and 'Appellate Authority' shall mean the following:
  - a) Functional Director shall be the 'Competent Authority' for the purpose of these guidelines. CMD, MDL shall be the 'Appellate Authority'.
  - b) CMD, MDL shall have overall power to take suo-moto action on any information available or received by him and pass such order(s) as he may think appropriate, including modifying the order(s) passed by any authority under these guidelines. Page No. 8.56 Amdt. No : 0 Date : 01/01/2015
- iv) 'Investigating Department' shall mean any Department or Unit investigating into the conduct of the Agency and shall include the Vigilance Department, Central Bureau of Investigation, the State Police or any other department set up by the Central or State Government having powers to investigate.
- v) 'List of approved Agencies - 'Bidder / Contractors / Suppliers / Purchasers / Customers shall mean and include list of approved / registered Agencies - 'Bidder / Contractors / Suppliers / Purchasers / Customers, etc

### 4. Initiation of Banning / Suspension

Action for banning / suspension business dealings with any Agency should be initiated by the department having business dealings with them after noticing the irregularities or misconduct on their part. Besides the concerned department, Vigilance Department may also be competent to initiate such action.

### 5. Suspension of Business Dealings

5.1 If the conduct of any Agency dealing with MDL is under investigation by any department, the Competent Authority may consider whether the allegations under investigation are of a serious nature and whether pending investigation, it would be advisable to continue business dealing with the Agency. If the Competent Authority, after consideration of the matter including the recommendation of the Investigating Department, if any, decides that it would not be in the interest to continue business dealings pending investigation, it may suspend business dealings with the Agency. The order to this effect may indicate a brief of the charges under investigation. If it is decided that inter-connected

Agencies would also come within the ambit of the order of suspension, the same should be specifically stated in the order. The order of suspension would operate for a period not more than six months and may be communicated to the Agency as also to the Investigating Department. The Investigating Department may ensure that their investigation is completed and whole process of final order is over within such period.

5.2 The order of suspension shall be communicated to all Commercial Departmental Heads. During the period of suspension, no business dealing may be held with the Agency.

5.3 As far as possible, the existing contract(s) with the Agency may continue unless the Competent Authority, having regard to the circumstances of the case, decides otherwise.

5.4 If the gravity of the misconduct under investigation is very serious and it would not be in the interest of MDL, as a whole, to deal with such an Agency pending investigation, the Competent Authority may order suspension of business dealing with Agency and send his recommendation to Chief Vigilance Officer (CVO), MDL alongwith the material available, copy of which may be issued to the Agency concerned with intimation to CVO MDL. Such an order would operate for a period of six months from the date of issue.

5.5 If the Agency concerned asks for detailed reasons of suspension, the Agency may be informed that its conduct is under investigation. It is not necessary to enter into correspondence or argument with the Agency at this stage.

5.6 It is not necessary to give any show-cause notice or personal hearing to the Agency before issuing the order of suspension. However, if investigations are not complete in six months' time, the Competent Authority may extend the period of suspension by another three months, during which period the investigations must be completed.

## **6. Ground on which Banning of Business Dealings can be initiated**

6.1 If the security consideration, including questions of loyalty of the Agency to the State, so warrants; Page No. 8.57 Amdt. No : 0 Date : 01/01/2015

6.2 If the Director / Owner of the Agency, proprietor or partner of the firm, is convicted by a Court of Law for offences involving moral turpitude in relation to its business dealings with the Government or any other public sector enterprises or MDL, during the last five years;

6.3 If there is strong justification for believing that the Directors, Proprietors, Partners, owner of the Agency have been guilty of malpractices such as bribery, corruption, fraud, substitution of tenders, interpolations, etc;

6.4 If the Agency continuously refuses to return / refund the dues of MDL without showing adequate reason and this is not due to any reasonable dispute which would attract proceedings in arbitration or Court of Law;

6.5 If the Agency employs a public servant dismissed / removed or employs a person convicted for an offence involving corruption or abetment of such offence;

6.6 If business dealings with the Agency have been banned/blacklisted by Government Agencies/ Statutory bodies, DGQA, Defence Shipyards, DPSUs or with whom commercial transactions have been suspended for sufficient and justifiable reasons. If the Agency having same promoters/Directors /Partners as the barred/blacklisted Company as at 6.6 above for the duration for which the barring/blacklisting of sister concern persists.



6.7 If the Agency has resorted to Corrupt, fraudulent practices including misrepresentation of facts; If the agency who had fraudulently dealt with the Company for pecuniary gains or had connived with dealing officers for mutual benefit.

6.8 If the Agency uses intimidation / threatening or brings undue outside pressure on the MDL or its official in acceptance / performances of the job under the contract;

6.9 If the Agency indulges in repeated and / or deliberate use of delay tactics in complying with contractual stipulations;

6.10 Wilful indulgence by the Agency in supplying sub-standard material irrespective of whether pre-despatch inspection was carried out by MDL or not;

6.11 Based on the findings of the investigation report of CBI / Police against the Agency for malafide / unlawful acts or improper conduct on his part in matters relating to the MDL or even otherwise;

6.12 Established litigant nature of the Agency to derive undue benefit;

6.13 Continued poor performance of the Agency in several contracts;

6.14 If the Agency misuses the premises or facilities of the MDL, forcefully occupies, tampers or damages the Company's properties including land, water resources, forests / trees, etc.

If the Agency who knowingly collude to defeat competition with the aim of deriving undeserved profit or gain from doing business with MDL.

(Note: The examples given above are only illustrative and not exhaustive. The Competent Authority may decide to ban business dealing for any good and sufficient reason).

## **7. Banning of Business Dealings**

7.1 Decision to ban business dealings with any Agency would apply throughout the Company.

7.2 There will be a Standing Committee to be appointed by the CMD which may include HOD of respective Commercial Section/Capital Works/OTS, HOD (M), rep of Legal Deptt. and OIC (SR&R) for processing the cases of "Banning of Business Dealings". The functions of the committee shall, inter-alia include:

i) To study the report of the Investigating Agency and decide if a prima-facie case for banning exists, if not, send back the case to the Competent Authority.

ii) To recommend for issue of show-cause notice to the Agency by the concerned department.

iii) To examine the reply to show-cause notice and call the Agency for personal hearing, if required.

iv) To submit final recommendation to the Competent Authority for banning or otherwise.

7.3 If the Competent Authority is prima-facie of view that action for banning business dealings with the Agency is called for, a show-cause notice may be issued to the Agency as per paragraph 9.1 and an enquiry held accordingly.

## **8 Removal from List of Approved Agencies - Suppliers / Contractors, etc.**

8.1 If the Competent Authority decides that the charge against the Agency is of a minor nature, it may issue a show-cause notice as to why the name of the Agency should not be removed from the list of approved Agencies - Suppliers / Contractors, etc.

8.2 The effect of such an order would be that the Agency would not be disqualified from competing in Open Tender Enquiries but LTE may not be given to the Agency concerned.

8.3 Past performance of the Agency may be taken into account while processing for approval of the Competent Authority for awarding the contract.

### **9. Show-cause Notice**

9.1 In case where the Competent Authority decides that action against an Agency is called for, a show-cause notice has to be issued to the Agency. Statement containing the imputation of misconduct or mis-behaviour may be appended to the show-cause notice and the Agency should be asked to submit within 15 days a written statement in its defence.

9.2 If the Agency requests for inspection of any relevant document in possession of MDL, necessary facility for inspection of documents may be provided.

9.3 The Competent Authority may consider and pass an appropriate speaking order:

- a) For exonerating the Agency if the charges are not established;
- b) For removing the Agency from the list of approved Suppliers / Contactors, etc.
- c) For banning the business dealing with the Agency.

9.4 If it decides to ban business dealings, the period for which the ban would be operative may be mentioned. The order may also mention that the ban would extend to the interconnected Agencies of the Agency.

### **10. Appeal against the Decision of the Competent Authority**

10.1 The Agency may file an appeal against the order of the Competent Authority banning business dealing, etc. The appeal shall lie to Appellate Authority. Such an appeal shall be preferred within one month from the date of receipt of the order banning business dealing, etc.

10.2 Appellate Authority would consider the appeal and pass appropriate order which shall be communicated to the Agency as well as the Competent Authority.

### **11. Review of the Decision by the Competent Authority**

Any petition / application filed by the Agency concerning the review of the banning order passed originally by Competent Authority under the existing guidelines either before or after filing of appeal before the Appellate Authority or after disposal of appeal by the Appellate Authority, the review petition can be decided by the Appellate Authority upon disclosure of new facts / circumstances or subsequent development necessitating such review. The Competent Authority may refer the same petition to the separate Standing Committee which may be constituted by Appellate Authority for examination and recommendation.

### **12. Circulation of the names of Agencies with whom Business Dealings have been banned**

12.1 Depending upon the gravity of misconduct established, the Competent Authority may direct HOD (Materials)/OIC (SR&R) to circulate the names of Agency with whom business dealings have been banned, to the Government Departments, other Public Sector Enterprises, etc. for such action as they deem appropriate.

12.2 If Government Departments or a Public Sector Enterprise request for more information about the Agency with whom business dealings have been banned, a copy of the report of Inquiring Authority together with a copy of the order of the Competent Authority / Appellate Authority may be supplied.

12.3 If business dealings with any Agency have been banned by the Central or State Government or any other Public Sector Enterprise, MDL may, without any further enquiry or investigation, issue an order banning business dealing with the Agency and its interconnected Agencies.

-----

## Corrigendum -3

- i) This corrigendum is being issued due to the following amendments in the tender.
- ii) The amendments are highlighted in the red.
- iii) Data sheet is attached for dimensions for Tommy holes in Hex nuts.
- iv) Bidders have to quote as per this corrigendum only.
- v) Offers not in line with this corrigendum will not be evaluated.

### 1. Description:

#### **PROCUREMENT OF FASTENERS FOR FLANGES FOR PART REPLACEMENT PIPELINE PROJECT (PRPP) FOR ONGC.**

#### **Note:**

i) There should be provision for 10% increase / decrease in quantity and the quoted unit prices to remain fixed(unchanged) for the same.

Provisions for 10% increase/decrease in quantity" is as under:

- a) 10% increase in quantity will be absorbed in the same PO price. No additional amount will be paid to vendor.
- b) In case of 10% decrease in quantity, amount equivalent to 10% short/less material will be deducted from the vendor amount.

ii) For fasteners 01 Set contains 01 No of Stud (Full Thread) + 02 Nos of Heavy Hex Nut ASTM A 193 Gr. B7M / ASTM A 194 2HM, ASME B 1.1 / ASME 18.2.2 + 02 Nos of Washers.

iii) Studs & Nuts shall be coated with 40 Micron Thick XYLAN coating of RED colour. Nuts to have hole for Tommy bar.

iv) Scope - As detailed in enclosure Functional Specifications

| SR NO. | Material /service details  | QTY | Unit |
|--------|--|-----|------|
| 10     | Material Number:-350000000000080685<br>Material group:-<br>1000000 - MISC ITEMS ( On charge off basis)<br>Material Details:-<br>Flange Size (inch): 16"<br>Rating : #1500<br>Material : Stud:- ASTM A 193 Gr. B7M<br>Nut:- ASTM A 194 Gr. 2HM<br>Size of stud : Diameter 2.5 inch x Length<br>910 mm<br>Coating : Xylan Coated | 400 | SET  |

|    |  |      |     |
|----|--|------|-----|
| 20 | Material Number:-350000000000080686<br>Material group:-<br>1000000 - MISC ITEMS ( On charge off basis)<br>Material Details:-<br>Flange Size (inch): 16"<br>Rating : #900<br>Material : Stud:- ASTM A 193 Gr. B7M<br>Nut:- ASTM A 194 Gr. 2HM<br>Size of Stud : Diameter 1.625 inch x Length 670 mm<br>Coating : Xylan Coated   | 1500 | SET |
| 30 | Material Number:-350000000000080687<br>Material group:-<br>1000000 - MISC ITEMS ( On charge off basis)<br>Material Details:-<br>Flange Size (inch): 14"<br>Rating : #1500<br>Material : Stud:- ASTM A 193 Gr. B7M<br>Nut:- ASTM A 194 Gr. 2HM<br>Size of stud : Diameter 2.25 inch x Length 840 mm<br>Coating : Xylan Coated   | 800  | SET |
| 40 | <del>Material Number:- 350000000000080689</del><br><del>Material group:-</del><br><del>1000000 - MISC ITEMS (On charge off basis)</del><br><del>Material Details:-</del><br>Flange Size (inch): 14"<br>Rating: #1500<br>Material: Stud:- ASTM A 193 Gr. B7M<br>Nut:- ASTM A 194 Gr. 2HM<br>Size of stud: Diameter 2.375 inch x Length 425 mm Coating : Xylan Coated        | 400  | SET |
| 50 | Material Number:-350000000000080690<br>Material group:-<br>1000000 - MISC ITEMS ( On charge off basis)<br>Material Details:-<br>Flange Size (inch): 12.75"<br>Rating : #1500<br>Material : Stud:- ASTM A 193 Gr. B7M<br>Nut:- ASTM A 194 Gr. 2HM<br>Size of stud Diameter 2 inch x Length 770 mm<br>Coating : Xylan Coated   | 2200 | SET |
| 60 | <del>Material Number:- 350000000000080691</del><br><del>Material group:-</del><br><del>1000000 - MISC ITEMS ( On charge off basis)</del><br><del>Material Details:-</del><br>Flange Size (inch): 12.75"<br>Rating: #1500<br>Material : Stud:- ASTM A 193 Gr. B7M<br>Nut:- ASTM A 194 Gr. 2HM<br>Size of stud : Diameter 2.0 inch x Length 650 mm<br>Coating : Xylan Coated | 400  | SET |

DELETED

DELETED

|     |   |      |     |
|-----|---|------|-----|
| 70  | Material Number:-350000000000080692<br>Material group:-<br>1000000 - MISC ITEMS ( On charge off basis)<br>Material Details:-<br>Flange Size (inch): 12.75"<br>Rating : #900<br>Material : Stud:- ASTM A 193 Gr. B7M<br>Nut:- ASTM A 194 Gr. 2HM<br>Size of stud : Diameter 1.375 inch x Length 640 mm<br>Coating : Xylan Coated | 2000 | SET |
| 80  | Material Number:-350000000000080693<br>Material group:-<br>1000000 - MISC ITEMS ( On charge off basis)<br>Material Details:-<br>Flange Size (inch): 10.75"<br>Rating : #900<br>Material : Stud:- ASTM A 193 Gr. B7<br>Nut:- ASTM A 194 Gr. 2H<br>Size of stud : Diameter 1.375 inch x Length 630 mm<br>Coating : Xylan Coated   | 800  | SET |
| 90  | Material Number:-350000000000080694<br>Material group:-<br>1000000 - MISC ITEMS ( On charge off basis)<br>Material Details:-<br>Flange Size (inch): 8.625"<br>Rating : #1500<br>Material : Stud:- ASTM A 193 Gr. B7M<br>Nut:- ASTM A 194 Gr. 2HM<br>Size of stud Diameter 1.625 inch x Length 670 mm<br>Coating : Xylan Coated  | 300  | SET |
| 100 | Material Number:-350000000000080695<br>Material group:-<br>1000000 - MISC ITEMS ( On charge off basis)<br>Material Details:-<br>Flange Size (inch): 6.625"<br>Rating : #1500<br>Material : Stud:- ASTM A 193 Gr. B7M<br>Nut:- ASTM A 194 Gr. 2HM<br>Size of stud : Diameter 1.375inch x Length 640 mm<br>Coating : Xylan Coated | 300  | SET |

Bidders shall confirm that the Scope of Supply and functional specifications at **Enclosure** is fully understood by them on their letterhead.

**Note:** - Any technical query related to SOW shall be forwarded to following:

Mr. Rupesh Mahajan, Chief Manager (PLG-EY).

E-mail: [rpmahajan@mazdock.com](mailto:rpmahajan@mazdock.com)

**Phone - 022-2376 3591**

**Or**

Mr Prashant Patil, Chief Manager (D-EY)

E-mail: [pbpatil@mazdock.com](mailto:pbpatil@mazdock.com)

**Phone - 022-2376 3591**

## 2 - JOINT/FLANGE PREPARATION

### 2.1 HEXAGONAL NUT DRILLING DETAILS

In order to allow the rotation of the standard hexagonal nut, tommy bar holes are required to be drilled into the flat of each nut. Drilling details are shown below in Fig. 2.

| HEXAGON NUT DRILLING – METRIC HEAVY SERIES |       |     |     |         |                  |
|--|-------|-----|-----|---------|------------------|
| BOLT DIA.                                  | Ø 'A' | 'B' | 'C' | NUT A/F | TOMMY BAR COLOUR |
| M20  | 5.2   | 7   | 4*  | 30      | Black            |
| M22  | 5.2   | 7   | 4*  | 32      |                  |
| M24  | 6.2   | 9   | 5*  | 36      | Yellow           |
| M27  | 6.2   | 9   | 5*  | 41      |                  |
| M30  | 8.2   | 12  | 6*  | 46      |                  |
| M33  | 8.2   | 12  | 7*  | 50      | Red              |
| M36  | 10.2  | 15  | 8*  | 55      |                  |
| M39  | 10.2  | 15  | 8   | 60      | Blue             |
| M42  | 10.2  | 15  | 9   | 65      |                  |
| M45  | 10.2  | 15  | 9   | 70      |                  |
| M48  | 12.4  | 18  | 11  | 75      |                  |
| M52  | 12.4  | 18  | 12  | 80      | White            |
| M56  | 14.4  | 21  | 12  | 85      |                  |
| M60  | 14.4  | 21  | 12  | 90      | Green            |
| M64  | 16.4  | 24  | 14  | 95      |                  |
| M68  | 16.4  | 24  | 14  | 100     | Brown            |
| M72  | 16.4  | 24  | 14  | 105     |                  |
| M76  | 16.4  | 24  | 15  | 110     |                  |
| M80  | 16.4  | 30  | 15  | 115     |                  |
| M85  | 16.4  | 30  | 15  | 120     |                  |
| M90  | 16.4  | 30  | 18  | 130     |                  |

| HEXAGON NUT DRILLING – IMPERIAL HEAVY SERIES |       |     |      |          |                  |
|--|-------|-----|------|----------|------------------|
| BOLT DIA.                                    | Ø 'A' | 'B' | 'C'  | NUT A/F  | TOMMY BAR COLOUR |
| 3/4"   | 6.2   | 9   | 5.5  | 1.1/4"   | Yellow           |
| 7/8"   | 6.2   | 9   | 6.0  | 1.7/16"  |                  |
| 1"   | 6.2   | 9   | 6.5  | 1.5/8"   |                  |
| 1.1/8"                                       | 6.2   | 9   | 7.0  | 1.13/16" |                  |
| 1.1/4"                                       | 8.2   | 12  | 8.0  | 2"       | Red              |
| 1.3/8"                                       | 8.2   | 12  | 8.5  | 2.3/16"  |                  |
| 1.1/2"                                       | 10.2  | 15  | 9.0  | 2.3/8"   | Blue             |
| 1.5/8"                                       | 10.2  | 15  | 9.5  | 2.9/16"  |                  |
| 1.3/4"                                       | 10.2  | 15  | 10.5 | 2.3/4"   |                  |
| 1.7/8"                                       | 10.2  | 15  | 11   | 2.15/16" |                  |
| 2"   | 12.4  | 18  | 12   | 3.1/8"   | White            |
| 2.1/4"                                       | 12.4  | 18  | 13   | 3.1/2"   |                  |
| 2.1/2"                                       | 14.4  | 21  | 15   | 3.7/8"   | Green            |
| 2.3/4"                                       | 14.4  | 21  | 16   | 4.1/4"   |                  |
| 3"   | 16.4  | 24  | 17   | 4.5/8"   | Brown            |
| 3.1/4"                                       | 16.4  | 24  | 18   | 5"       |                  |
| 3.1/2"                                       | 16.4  | 24  | 19   | 5.3/8"   |                  |

**Note:**

- The above tables are for use with heavy series nuts only.
- Dimension 'C' denotes maximum hole depth to drill point. Unless otherwise specified.
- \* Indicates the use of a Flat Bottom Drill

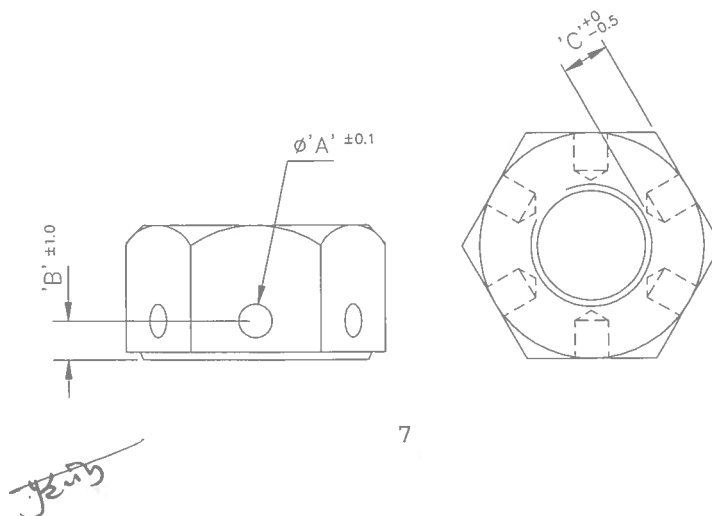

FIG 2

**Enclosure-2****RATE SHEET PRESCRIBED FORMAT***(Please quote on your letter head only)***Note: Do not mention prices.**

| Sr.No | Material/Service description   | Qty  | Unit | Quoted/Not quoted |
|-------|--|------|------|-------------------|
| 10    | Material Number:-350000000000080685<br>Material group:-<br>1000000 - MISC ITEMS ( On charge off basis)<br>Material Details:-<br>Flange Size (inch): 16"<br>Rating : #1500<br>Material : Stud:- ASTM A 193 Gr. B7M<br>Nut:- ASTM A 194 Gr. 2HM<br>Size of stud : Diameter 2.5 inch x Length<br>910 mm<br>Coating : Xylan Coated   | 400  | SET  |                   |
| 20    | Material Number:-350000000000080686<br>Material group:-<br>1000000 - MISC ITEMS ( On charge off basis)<br>Material Details:-<br>Flange Size (inch): 16"<br>Rating : #900<br>Material : Stud:- ASTM A 193 Gr. B7M<br>Nut:- ASTM A 194 Gr. 2HM<br>Size of Stud : Diameter 1.625 inch x Length 670<br>mm<br>Coating : Xylan Coated  | 1500 | SET  |                   |
| 30    | Material Number:-350000000000080687<br>Material group:-<br>1000000 - MISC ITEMS ( On charge off basis)<br>Material Details:-<br>Flange Size (inch): 14"<br>Rating : #1500<br>Material : Stud:- ASTM A 193 Gr. B7M<br>Nut:- ASTM A 194 Gr. 2HM<br>Size of stud : Diameter 2.25 inch x Length 840 mm<br>Coating : Xylan Coated   | 800  | SET  |                   |
| 40    | Material Number: <del>350000000000080689</del><br>Material group: <del>-</del><br><del>1000000 - MISC ITEMS (On charge off</del><br><del>basis)</del><br>Material Details: <del>-</del><br>Flange Size (inch): <del>14"</del><br>Rating: <del>#1500</del><br>Material: Stud: <del>ASTM A 193 Gr. B7M</del><br>Nut: <del>ASTM A 194 Gr. 2HM</del><br>Size of stud: <del>Diameter 2.375 inch x Length 425 mm</del> Coating :<br>Xylan Coated | 400  | SET  |                   |
| 50    | Material Number:-350000000000080690<br>Material group:-<br>1000000 - MISC ITEMS ( On charge off basis)<br>Material Details:-<br>Flange Size (inch): 12.75"<br>Rating : #1500   | 2200 | SET  |                   |

|     |  |      |     |         |
|-----|--|------|-----|---------|
|     | Material : Stud:- ASTM A 193 Gr. B7M<br>Nut:- ASTM A 194 Gr. 2HM<br>Size of stud Diameter 2 inch x Length 770 mm<br>Coating : Xylan Coated   |      |     |         |
| 60  | Material Number:- <del>350000000000080691</del><br>Material group:-<br><del>1000000 - MISC ITEMS ( On charge off basis)</del><br>Material Details:-<br>Flange Size (inch):- <del>12.75"</del><br>Rating : # <del>1500</del><br>Material : Stud:- <del>ASTM A 193 Gr. B7M</del><br>Nut:- <del>ASTM A 194 Gr. 2HM</del><br>Size of stud : Diameter <del>2.0 inch</del> x Length <del>650 mm</del><br>Coating : <del>Xylan Coated</del> | 400  | SET | DELETED |
| 70  | Material Number:-350000000000080692<br>Material group:-<br>1000000 - MISC ITEMS ( On charge off basis)<br>Material Details:-<br>Flange Size (inch): 12.75"<br>Rating : #900<br>Material : Stud:- ASTM A 193 Gr. B7M<br>Nut:- ASTM A 194 Gr. 2HM<br>Size of stud : Diameter 1.375 inch x Length 640 mm<br>Coating : Xylan Coated  | 2000 | SET |         |
| 80  | Material Number:-350000000000080693<br>Material group:-<br>1000000 - MISC ITEMS ( On charge off basis)<br>Material Details:-<br>Flange Size (inch): 10.75"<br>Rating : #900<br>Material : Stud:- ASTM A 193 Gr. B7<br>Nut:- ASTM A 194 Gr. 2H<br>Size of stud : Diameter 1.375 inch x Length 630 mm<br>Coating : Xylan Coated  | 800  | SET |         |
| 90  | Material Number:-350000000000080694<br>Material group:-<br>1000000 - MISC ITEMS ( On charge off basis)<br>Material Details:-<br>Flange Size (inch): 8.625"<br>Rating : #1500<br>Material : Stud:- ASTM A 193 Gr. B7M<br>Nut:- ASTM A 194 Gr. 2HM<br>Size of stud Diameter 1.625 inch x Length 670 mm<br>Coating : Xylan Coated   | 300  | SET |         |
| 100 | Material Number:-350000000000080695<br>Material group:-<br>1000000 - MISC ITEMS ( On charge off basis)<br>Material Details:-<br>Flange Size (inch): 6.625"<br>Rating : #1500<br>Material : Stud:- ASTM A 193 Gr. B7M<br>Nut:- ASTM A 194 Gr. 2HM<br>Size of stud : Diameter 1.375inch x Length 640 mm<br>Coating : Xylan Coated  | 300  | SET |         |



|  |  |
|--|--|
| <p><b>a. The seller has read, understood and accept the complete Scope of work. (Yes/No)</b></p> |  |
|--|--|

| <p align="center"><b>Taxes and duties</b></p>                        |  |  |
|--|--|--|
| <p align="center"><b>Tax head</b></p>                                | <p align="center"><b>Rate applicable</b></p> | <p align="center"><b>Percentage of total Amount on which the tax is applicable</b></p> |
| <p align="center">GST</p>  |  |  |
| <p align="center">Any other Taxes/Duties<br/>(Bidder to specify)</p> |  |  |

**Note:**

- i) **The Prices indicated in the Price Bid shall be as per rate sheet only. (Please check carefully for taxes before bidding).**
- ii) **The bidder shall provide the quoted price breakup of all the items after price bid opening.**

Name: .....

Designation: .....

Date: .....

Bidders Company Seal .....

-----

## Corrigendum -2

- i) This corrigendum is being issued due to the following amendments in the tender.
- ii) The amendments are highlighted in the red.
- iii) Bidders have to quote as per the corrigendum only.
- iv) Offers not in line with this corrigendum will not be evaluated.

### TEF CLAUSE 1. Description:

#### PROCUREMENT OF FASTENERS FOR FLANGES FOR PART REPLACEMENT PIPELINE PROJECT (PRPP) FOR ONGC.

#### Note:

i) There should be provision for 10% increase / decrease in quantity and the quoted unit prices to remain fixed(unchanged) for the same.

Provisions for 10% increase/decrease in quantity" is as under:

a) 10% increase in quantity will be absorbed in the same PO price. No additional amount will be paid to vendor.

b) In case of 10% decrease in quantity, amount equivalent to 10% short/less material will be deducted from the vendor amount.

ii) For fasteners 01 Set contains 01 No of Stud (Full Thread) + 02 Nos of Heavy Hex Nut ASTM A 193 Gr. B7M / ASTM A 194 2HM, ASME B 1.1 / ASME 18.2.2 + 02 Nos of Washers.

iii) Studs & Nuts shall be coated with 40 Micron Thick XYLAN coating of RED colour. Nuts to have hole for Tommy bar.

| SR NO. | Material /service details  | QTY  | Unit |
|--------|--|------|------|
| 10     | Material Number: -350000000000080685<br>Material group:-<br>1000000 - MISC ITEMS ( On charge off basis)<br>Material Details:-<br>Flange Size (inch): 16"<br>Rating : #1500<br>Material : Stud:- ASTM A 193 Gr. B7M<br>Nut:- ASTM A 194 Gr. 2HM<br>Size of stud : Diameter 2.5 inch x Length 760 mm<br>Coating : Xylan Coated | 400  | SET  |
| 20     | Material Number:-350000000000080686<br>Material group:-<br>1000000 - MISC ITEMS ( On charge off basis)<br>Material Details:-<br>Flange Size (inch): 16"<br>Rating : #900<br>Material : Stud:- ASTM A 193 Gr. B7M<br>Nut:- ASTM A 194 Gr. 2HM<br>Size of Stud : Diameter 1.625 inch x Length 570 mm<br>Coating : Xylan Coated | 1500 | SET  |

|    |  |      |     |
|----|--|------|-----|
| 30 | Material Number:-350000000000080687<br>Material group:-<br>1000000 - MISC ITEMS ( On charge off basis)<br>Material Details:-<br>Flange Size (inch): 14"<br>Rating : #1500<br>Material : Stud:- ASTM A 193 Gr. B7M<br>Nut:- ASTM A 194 Gr. 2HM<br>Size of stud : Diameter 2.25 inch x Length 690 mm<br>Coating : Xylan Coated                                       | 800  | SET |
| 40 | <del>Material Number:-350000000000080689</del><br><del>Material group:-</del><br><del>1000000 - MISC ITEMS (On charge off basis)</del><br><del>Material Details:-</del><br>Flange Size (inch): 14"<br>Rating: #1500<br>Material: Stud:- ASTM A 193 Gr. B7M<br>Nut:- ASTM A 194 Gr. 2HM<br>Size of stud: Diameter 2.375 inch x Length 425 mm Coating : Xylan Coated | 400  | SET |
| 50 | Material Number:-350000000000080690<br>Material group:-<br>1000000 - MISC ITEMS ( On charge off basis)<br>Material Details:-<br>Flange Size (inch): 12.75"<br>Rating : #1500<br>Material : Stud:- ASTM A 193 Gr. B7M<br>Nut:- ASTM A 194 Gr. 2HM<br>Size of stud Diameter 2 inch x Length 650 mm<br>Coating : Xylan Coated   | 1800 | SET |
| 60 | Material Number:-350000000000080691<br>Material group:-<br>1000000 - MISC ITEMS ( On charge off basis)<br>Material Details:-<br>Flange Size (inch): 12.75"<br>Rating : #1500<br>Material : Stud:- ASTM A 193 Gr. B7M<br>Nut:- ASTM A 194 Gr. 2HM<br>Size of stud : Diameter 2.0 inch x Length 650 mm<br>Coating : Xylan Coated                                     | 400  | SET |
| 70 | Material Number:-350000000000080692<br>Material group:-<br>1000000 - MISC ITEMS ( On charge off basis)<br>Material Details:-<br>Flange Size (inch): 12.75"<br>Rating : #900<br>Material : Stud:- ASTM A 193 Gr. B7M<br>Nut:- ASTM A 194 Gr. 2HM<br>Size of stud : Diameter 1.375 inch x Length 540 mm<br>Coating : Xylan Coated                                    | 2000 | SET |
| 80 | Material Number:-350000000000080693<br>Material group:-<br>1000000 - MISC ITEMS ( On charge off basis)<br>Material Details:-<br>Flange Size (inch): 10.75"<br>Rating : #900<br>Material : Stud:- ASTM A 193 Gr. B7<br>Nut:- ASTM A 194 Gr. 2H<br>Size of stud : Diameter 1.375 inch x Length 530 mm<br>Coating : Xylan Coated                                      | 800  | SET |



|     |   |     |     |
|-----|---|-----|-----|
| 90  | Material Number:-350000000000080694<br>Material group:-<br>1000000 - MISC ITEMS ( On charge off basis)<br>Material Details:-<br>Flange Size (inch): 8.625"<br>Rating : #1500<br>Material : Stud:- ASTM A 193 Gr. B7M<br>Nut:- ASTM A 194 Gr. 2HM<br>Size of stud Diameter 1.625 inch x Length 570 mm<br>Coating : Xylan Coated  | 300 | SET |
| 100 | Material Number:-350000000000080695<br>Material group:-<br>1000000 - MISC ITEMS ( On charge off basis)<br>Material Details:-<br>Flange Size (inch): 6.625"<br>Rating : #1500<br>Material : Stud:- ASTM A 193 Gr. B7M<br>Nut:- ASTM A 194 Gr. 2HM<br>Size of stud : Diameter 1.375inch x Length 540 mm<br>Coating : Xylan Coated | 300 | SET |

Bidders shall confirm that the Scope of Supply and functional specifications at **Enclosure** is fully understood by them on their letterhead.

**Note:** - Any technical query related to SOW shall be forwarded to following:

Mr. Rupesh Mahajan, Chief Manager (PLG-EY).

E-mail: [rpmahajan@mazdock.com](mailto:rpmahajan@mazdock.com)

**Phone - 022-2376 3604**

**Or**

Mr Prashant Patil, Chief Manager (D-EY)

E-mail: [pbpatil@mazdock.com](mailto:pbpatil@mazdock.com)

**Phone - 022-2376 3604**

## Corrigendum -1

- i) This corrigendum is being issued due to the following amendments in the tender.
- ii) The amendments are highlighted in the red.
- iii) Bidders have to quote as per this corrigendum only.
- iv) Offers not in line with this corrigendum will not be evaluated.

### 1. Description:

#### **PROCUREMENT OF FASTENERS FOR FLANGES FOR PART REPLACEMENT PIPELINE PROJECT (PRPP) FOR ONGC.**

#### **Note:**

i) There should be provision for 10% increase / decrease in quantity and the quoted unit prices to remain fixed(unchanged) for the same.

Provisions for 10% increase/decrease in quantity" is as under:

a) 10% increase in quantity will be absorbed in the same PO price. No additional amount will be paid to vendor.

b) In case of 10% decrease in quantity, amount equivalent to 10% short/less material will be deducted from the vendor amount.

ii) For fasteners 01 Set contains 01 No Stud, 02 Nos Nuts & 02 Nos Washers

iii) Studs & Nuts shall be coated with 40 Micron Thick Xylan (PTFE). Colour of coating shall be RED.

| SR NO. | Material /service details  | QTY  | Unit |
|--------|--|------|------|
| 10     | Material Number: -350000000000080685<br>Material group:-<br>1000000 - MISC ITEMS ( On charge off basis)<br>Material Details:-<br>Flange Size (inch): 16"<br>Rating : #1500<br>Material : Stud:- ASTM A 193 Gr. B7M<br>Nut:- ASTM A 194 Gr. 2HM<br>Size of stud : Diameter 2.5 inch x Length 760 mm<br>Coating : Xylan Coated | 400  | SET  |
| 20     | Material Number:-350000000000080686<br>Material group:-<br>1000000 - MISC ITEMS ( On charge off basis)<br>Material Details:-<br>Flange Size (inch): 16"<br>Rating : #900<br>Material : Stud:- ASTM A 193 Gr. B7M<br>Nut:- ASTM A 194 Gr. 2HM<br>Size of Stud : Diameter 1.625 inch x Length 570 mm<br>Coating : Xylan Coated | 1500 | SET  |

|    |  |      |     |
|----|--|------|-----|
| 30 | <p>Material Number:-350000000000080687<br/> Material group:-<br/> 1000000 - MISC ITEMS ( On charge off basis)<br/> Material Details:-<br/> Flange Size (inch): 14"<br/> Rating : #1500<br/> Material : Stud:- ASTM A 193 Gr. B7M<br/> Nut:- ASTM A 194 Gr. 2HM<br/> Size of stud : Diameter 2.25 inch x Length 690 mm<br/> Coating : Xylan Coated</p>      | 800  | SET |
| 40 | <p><del>Material Number:-350000000000080689<br/> Material group:-<br/> 1000000 - MISC ITEMS (On charge off basis)<br/> Material Details:-<br/> Flange Size (inch): 14"<br/> Rating : #1500<br/> Material : Stud:- ASTM A 193 Gr. B7M<br/> Nut:- ASTM A 194 Gr. 2HM<br/> Size of stud: Diameter 2.375 inch x Length 425 mm Coating : Xylan Coated</del></p> | 400  | SET |
| 50 | <p>Material Number:-350000000000080690<br/> Material group:-<br/> 1000000 - MISC ITEMS ( On charge off basis)<br/> Material Details:-<br/> Flange Size (inch): 12.75"<br/> Rating : #1500<br/> Material : Stud:- ASTM A 193 Gr. B7M<br/> Nut:- ASTM A 194 Gr. 2HM<br/> Size of stud Diameter 2 inch x Length 650 mm<br/> Coating : Xylan Coated</p>        | 1800 | SET |
| 60 | <p>Material Number:-350000000000080691<br/> Material group:-<br/> 1000000 - MISC ITEMS ( On charge off basis)<br/> Material Details:-<br/> Flange Size (inch): 12.75"<br/> Rating : #1500<br/> Material : Stud:- ASTM A 193 Gr. B7M<br/> Nut:- ASTM A 194 Gr. 2HM<br/> Size of stud : Diameter 2.0 inch x Length 650 mm<br/> Coating : Xylan Coated</p>    | 400  | SET |
| 70 | <p>Material Number:-350000000000080692<br/> Material group:-<br/> 1000000 - MISC ITEMS ( On charge off basis)<br/> Material Details:-<br/> Flange Size (inch): 12.75"<br/> Rating : #900<br/> Material : Stud:- ASTM A 193 Gr. B7M<br/> Nut:- ASTM A 194 Gr. 2HM<br/> Size of stud : Diameter 1.375 inch x Length 540 mm<br/> Coating : Xylan Coated</p>   | 2000 | SET |
| 80 | <p>Material Number:-350000000000080693<br/> Material group:-<br/> 1000000 - MISC ITEMS ( On charge off basis)<br/> Material Details:-<br/> Flange Size (inch): 10.75"<br/> Rating : #900<br/> Material : Stud:- ASTM A 193 Gr. B7<br/> Nut:- ASTM A 194 Gr. 2H<br/> Size of stud : Diameter 1.375 inch x Length 530 mm<br/> Coating : Xylan Coated</p>     | 800  | SET |

DELETED

|     |   |     |     |
|-----|---|-----|-----|
| 90  | Material Number:-350000000000080694<br>Material group:-<br>1000000 - MISC ITEMS ( On charge off basis)<br>Material Details:-<br>Flange Size (inch): 8.625"<br>Rating : #1500<br>Material : Stud:- ASTM A 193 Gr. B7M<br>Nut:- ASTM A 194 Gr. 2HM<br>Size of stud Diameter 1.625 inch x Length 570 mm<br>Coating : Xylan Coated  | 300 | SET |
| 100 | Material Number:-350000000000080695<br>Material group:-<br>1000000 - MISC ITEMS ( On charge off basis)<br>Material Details:-<br>Flange Size (inch): 6.625"<br>Rating : #1500<br>Material : Stud:- ASTM A 193 Gr. B7M<br>Nut:- ASTM A 194 Gr. 2HM<br>Size of stud : Diameter 1.375inch x Length 540 mm<br>Coating : Xylan Coated | 300 | SET |

Bidders shall confirm that the Scope of Supply and functional specifications at **Enclosure** is fully understood by them on their letterhead.

**Note:** - Any technical query related to SOW shall be forwarded to following:

Mr. Rupesh Mahajan, Chief Manager (PLG-EY).

E-mail: [rpmahajan@mazdock.com](mailto:rpmahajan@mazdock.com)

**Phone - 022-2376 3604**

**Or**

Mr Prashant Patil, Chief Manager (D-EY)

E-mail: [pbpatil@mazdock.com](mailto:pbpatil@mazdock.com)

**Phone - 022-2376 3604**

**Enclosure-2****RATE SHEET PRESCRIBED FORMAT***(Please quote on your letter head only)***Note: Do not mention prices.**

| Sr.No | Material/Service description  | Qty  | Unit | Quoted/Not quoted |
|-------|---|------|------|-------------------|
| 10    | Material Number: -350000000000080685<br>Material group:-<br>1000000 - MISC ITEMS ( On charge off basis)<br>Material Details:-<br>Flange Size (inch): 16"<br>Rating : #1500<br>Material : Stud:- ASTM A 193 Gr. B7M<br>Nut:- ASTM A 194 Gr. 2HM<br>Size of stud : Diameter 2.5 inch x Length 760 mm<br>Coating : Xylan Coated  | 400  | SET  |                   |
| 20    | Material Number:-350000000000080686<br>Material group:-<br>1000000 - MISC ITEMS ( On charge off basis)<br>Material Details:-<br>Flange Size (inch): 16"<br>Rating : #900<br>Material : Stud:- ASTM A 193 Gr. B7M<br>Nut:- ASTM A 194 Gr. 2HM<br>Size of Stud : Diameter 1.625 inch x Length 570 mm<br>Coating : Xylan Coated  | 1500 | SET  |                   |
| 30    | Material Number:-350000000000080687<br>Material group:-<br>1000000 - MISC ITEMS ( On charge off basis)<br>Material Details:-<br>Flange Size (inch): 14"<br>Rating : #1500<br>Material : Stud:- ASTM A 193 Gr. B7M<br>Nut:- ASTM A 194 Gr. 2HM<br>Size of stud : Diameter 2.25 inch x Length 690 mm<br>Coating : Xylan Coated  | 800  | SET  |                   |
| 40    | <del>Material Number: -350000000000080689</del><br><del>Material group:-</del><br><del>1000000 - MISC ITEMS (On charge off basis)</del><br><del>Material Details:-</del><br>Flange Size (inch): 14" Rating: #1500<br>Material: Stud: - ASTM A 193 Gr. B7M<br>Nut: - ASTM A 194 Gr. 2HM<br>Size of stud: Diameter 2.375 inch x Length 425 mm Coating :<br>Xylan Coated | 400  | SET  |                   |
| 50    | Material Number:-350000000000080690<br>Material group:-<br>1000000 - MISC ITEMS ( On charge off basis)<br>Material Details:-<br>Flange Size (inch): 12.75"<br>Rating : #1500<br>Material : Stud:- ASTM A 193 Gr. B7M<br>Nut:- ASTM A 194 Gr. 2HM<br>Size of stud Diameter 2 inch x Length 650 mm<br>Coating : Xylan Coated  | 1800 | SET  |                   |

**DELETED**



|     |   |      |     |  |
|-----|---|------|-----|--|
| 60  | Material Number:-350000000000080691<br>Material group:-<br>1000000 - MISC ITEMS ( On charge off basis)<br>Material Details:-<br>Flange Size (inch): 12.75"<br>Rating : #1500<br>Material : Stud:- ASTM A 193 Gr. B7M<br>Nut:- ASTM A 194 Gr. 2HM<br>Size of stud : Diameter 2.0 inch x Length 650 mm<br>Coating : Xylan Coated  | 400  | SET |  |
| 70  | Material Number:-350000000000080692<br>Material group:-<br>1000000 - MISC ITEMS ( On charge off basis)<br>Material Details:-<br>Flange Size (inch): 12.75"<br>Rating : #900<br>Material : Stud:- ASTM A 193 Gr. B7M<br>Nut:- ASTM A 194 Gr. 2HM<br>Size of stud : Diameter 1.375 inch x Length 540 mm<br>Coating : Xylan Coated | 2000 | SET |  |
| 80  | Material Number:-350000000000080693<br>Material group:-<br>1000000 - MISC ITEMS ( On charge off basis)<br>Material Details:-<br>Flange Size (inch): 10.75"<br>Rating : #900<br>Material : Stud:- ASTM A 193 Gr. B7<br>Nut:- ASTM A 194 Gr. 2H<br>Size of stud : Diameter 1.375 inch x Length 530 mm<br>Coating : Xylan Coated   | 800  | SET |  |
| 90  | Material Number:-350000000000080694<br>Material group:-<br>1000000 - MISC ITEMS ( On charge off basis)<br>Material Details:-<br>Flange Size (inch): 8.625"<br>Rating : #1500<br>Material : Stud:- ASTM A 193 Gr. B7M<br>Nut:- ASTM A 194 Gr. 2HM<br>Size of stud Diameter 1.625 inch x Length 570 mm<br>Coating : Xylan Coated  | 300  | SET |  |
| 100 | Material Number:-350000000000080695<br>Material group:-<br>1000000 - MISC ITEMS ( On charge off basis)<br>Material Details:-<br>Flange Size (inch): 6.625"<br>Rating : #1500<br>Material : Stud:- ASTM A 193 Gr. B7M<br>Nut:- ASTM A 194 Gr. 2HM<br>Size of stud : Diameter 1.375inch x Length 540 mm<br>Coating : Xylan Coated | 300  | SET |  |

**a. The seller has read, understood and accept the complete Scope of work.  
(Yes/No)**

| <b>Taxes and duties</b>                       |                        |  |
|---|------------------------|--|
| <b>Tax head</b>                               | <b>Rate applicable</b> | <b>Percentage of total Amount on which the tax is applicable</b> |
| GST   |                        |  |
| Any other Taxes/Duties<br>(Bidder to specify) |                        |  |

**Note:**

- i) The Prices indicated in the Price Bid shall be as per rate sheet only. (Please check carefully for taxes before bidding).**
- ii) The bidder shall provide the quoted price breakup of all the items after price bid opening.**

Name: .....

Designation: .....

Date: .....

Bidders Company Seal .....

-----



निविदा पूछताछ  
TENDER ENQUIRY

[वेब निविदा]  
[WEB TENDER]

माझगांव डॉक शिपबिल्डर्स लिमिटेड  
(भारत सरकार का उपक्रम)  
MAZAGON DOCK SHIPBUILDERS LIMITED  
(Formerly known as Mazagon Dock Limited)  
(A Govt. of India Undertaking)  
CIN: L35100MH1934GOI002079  
Dockyard Road, Mumbai 400 010  
Website- [www.mazagondock.in](http://www.mazagondock.in)  
Certified - ISO 9001: 2008 for Shipbuilding Division  
GST ID : 27AAACM8029J1ZA

|                             |               |  |                                |
|-----------------------------|---------------|--|--------------------------------|
| निविदा सं./Tender No        | 1200003191    | विभाग/Department                           | EY COMMERCIAL                  |
| क्रय अधिकारी/Purchase Exec. | Ranjeet Kumar | क्रय अधिकारी/Purchase Exec.                | Ranjeet Kumar                  |
| सेवा में/To                 |               | दूरभाष सं./Telephone No                    | 23763570                       |
|                             |               | फैक्स सं./Fax No                           | 23741386                       |
|                             |               | ई-मेल/E-Mail                               | ranjeetkumar100261@mazdock.com |
| दूरभाष सं./Telephone        |               | निविदा सं./Tender No                       | 1200003191                     |
| फैक्स सं./Fax               |               | निविदा तिथि/ Tender Date                   | 28.03.2024                     |
| ई-मेल/E-Mail                |               | निविदा बंद की तिथि/Tender Closing Date     | 05.04.2024                     |
|                             |               | निविदा बंद होने का समय/Tender Closing Time | 12:00:00                       |
|                             |               | आरएफक्यू सं./RFQ No                        | 2200000431                     |

|  |       |                              |
|--|-------|------------------------------|
| निविदा शुल्क/Tender Fee                                | रु/Rs | 0.00                         |
| बयाना राशि/EMD Amount                                  | रु/Rs | 300,000.00                   |
| पुर्व बिड बैठक तिथि और समय/Pre Bid Meeting Date & Time |       | ,00:00:00                    |
| निविदा खोलने की तिथि और समय/Tender Opening Date & Time |       | 05.04.2024,15:00:00          |
| प्रस्ताव वैधता तिथि है/Offer should be valid up to     |       | 02.10.2024                   |
| सुरक्षा जमा/Security Deposit                           |       | 5.00 %आदेश मूल्य का/PO value |
| वरीय बैंक जमानत /Perf. Bank Guarantee                  |       | 5.00 %आदेश मूल्य का/PO value |

( आगे के विवरण हेतु कृपया सम्बंधित नियम शर्तों को पढ़ें। सुनिश्चित करें कि कोटेशन और संबंधित पत्राचार के लिए विभाग का नाम, क्रय अधिकारी का नाम, निविदा संख्या, बंद होने का समय एवं तिथि एवं आरएफक्यू सं. अपने कोटेशनमें लिखें।  
Kindly read and refer relevant terms & conditions for further details. Do ensure to Quote Department Name, Purchase Executive \$ Name , Tender Number, closing date & time and RFQ Number in your Quotation & related correspondence )

प्रिय महोदय/महोदया  
Dear Sir / Madam ,

विषय /SUB:- PROCUREMENT OF FASTENERS FOR FLANGES FOR PART REPLACEMENT PIPELINE PROJECT (PRPP) FOR ONGC.

माझगाँव डॉक शिपबिल्डर्स लिमिटेड प्रतिष्ठित/संभावित आपूर्तिकर्ताओं से निम्न हेतु, प्रतियोगितात्मक दो बोली प्रणाली में ( भाग -I तकनीकी - वाणिज्य बोली एवं भाग II मूल्य बोली ) बोली आमंत्रित करती है।  
Mazagon Dock Shipbuilders Limited (MDL) invites Competitive – Bid from reputed Supplier for the following in TWO BID system ( Part - I Techno - Commercial Bid & Part - II Price Bid ) .

| क्र सं.<br>SL.No. | सामग्री / सेवा विवरण<br>Material / Service Details   | मात्रा / इकाई<br>Quantity / unit | आपूर्ति तिथि<br>Delivery Date |
|-------------------|--|----------------------------------|-------------------------------|
| 00010             | सामग्री सं./ Material Number :- 350000000000080685<br>SI No. 1 Studs & Nuts & Washers<br>सामग्री वर्णन/Material Description :Flange Size (inch): 16" | 400 SET                          | 24.04.2024                    |

| निविदा सं./ Tender No:- 1200003191 |  | निविदा तिथि/ Tender Date:- 28.03.2024 |                               | आरएफक्यू सं./RFQ No:- 2200000431 |  |
|------------------------------------|--|---------------------------------------|-------------------------------|----------------------------------|--|
| क्र सं.<br>SL.No.                  | सामग्री / सेवा विवरण<br>Material / Service Details   | मात्रा / इकाई<br>Quantity / unit      | आपूर्ति तिथि<br>Delivery Date |                                  |  |
|                                    | Rating : #1500<br>Material : Stud:- ASTM A 320 Grade L43<br>Nut:- ASTM A 194 Gr. 7<br>Size of stud : Diameter 2.5 inch x Length 470 mm<br>Coating : Xylan Coated   |                                       |                               |                                  |  |
| 00020                              | सामग्री सं./ Material Number :- 350000000000080686<br>SI No. 2 Studs & Nuts & Washers<br>सामग्री वर्णन/Material Description :Flange Size (inch): 16"<br>Rating : #900<br>Material : Stud:- ASTM A 193 Gr. B7M<br>Nut:- ASTM A 194 Gr. 2HM<br>Size of Stud : Diameter 1.625 inch x Length 290 mm<br>Coating : Xylan Coated  | 1,500 SET                             | 24.04.2024                    |                                  |  |
| 00030                              | सामग्री सं./ Material Number :- 350000000000080687<br>SI No. 3 Studs & Nuts & Washers<br>सामग्री वर्णन/Material Description :Flange Size (inch): 14"<br>Rating : #1500<br>Material : Stud:- ASTM A 193 Gr. B7M<br>Nut:- ASTM A 194 Gr. 2HM<br>Size of stud : Diameter 2.25 inch x Length 425 mm<br>Coating : Xylan Coated  | 400 SET                               | 24.04.2024                    |                                  |  |
| 00040                              | सामग्री सं./ Material Number :- 350000000000080689<br>SI No. 4 Studs & Nuts & Washers<br>सामग्री वर्णन/Material Description :Flange Size (inch): 14"<br>Rating : #1500<br>Material : Stud:- ASTM A 193 Gr. B7M<br>Nut:- ASTM A 194 Gr. 2HM<br>Size of stud : Diameter 2.375 inch x Length 425 mm<br>Coating : Xylan Coated | 400 SET                               | 24.04.2024                    |                                  |  |
| 00050                              | सामग्री सं./ Material Number :- 350000000000080690<br>SI No. 5 Studs & Nuts & Washers<br>सामग्री वर्णन/Material Description :Flange Size (inch): 12.75"<br>Rating : #1500<br>Material : Stud:- ASTM A 193 Gr. B7M<br>Nut:- ASTM A 194 Gr. 2HM<br>Size of stud Diameter 2 inch x Length 385 mm                              | 1,200 SET                             | 24.04.2024                    |                                  |  |

| क्र सं.<br>SL.No. | सामग्री / सेवा विवरण<br>Material / Service Details   | मात्रा / इकाई<br>Quantity / unit | आपूर्ति तिथि<br>Delivery Date |
|-------------------|--|----------------------------------|-------------------------------|
|                   | Coating : Xylan Coated   |                                  |                               |
| 00060             | सामग्री सं./ Material Number :- 350000000000080691<br>SI No. 6 Studs & Nuts & Washers<br>सामग्री वर्णन/Material Description :Flange Size (inch): 12.75"<br>Rating : #1500<br>Material : Stud:- ASTM A 193 Gr. B7M<br>Nut:- ASTM A 194 Gr. 2HM<br>Diameter 1.375 inch x Length 385 mm<br>Coating : Xylan Coated               | 1,000 SET                        | 24.04.2024                    |
| 00070             | सामग्री सं./ Material Number :- 350000000000080692<br>SI No. 7 Studs & Nuts & Washers<br>सामग्री वर्णन/Material Description :Flange Size (inch): 12.75"<br>Rating : #900<br>Material : Stud:- ASTM A 193 Gr. B7M<br>Nut:- ASTM A 194 Gr. 2HM<br>Size of stud : Diameter 1.375 inch x Length 255 mm<br>Coating : Xylan Coated | 2,000 SET                        | 24.04.2024                    |
| 00080             | सामग्री सं./ Material Number :- 350000000000080693<br>SI No. 8 Studs & Nuts & Washers<br>सामग्री वर्णन/Material Description :Flange Size (inch): 10.75"<br>Rating : #900<br>Material : Stud:- ASTM A 193 Gr. B7<br>Nut:- ASTM A 194 Gr. 2H<br>Size of stud : Diameter 1.375 inch x Length 235 mm<br>Coating : Xylan Coated   | 800 SET                          | 24.04.2024                    |
| 00090             | सामग्री सं./ Material Number :- 350000000000080694<br>SI No. 9 Studs & Nuts & Washers<br>सामग्री वर्णन/Material Description :Flange Size (inch): 8.625"<br>Rating : #1500<br>Material : Stud:- ASTM A 193 Gr. B7M<br>Nut:- ASTM A 194 Gr. 2HM<br>Size of stud Diameter 1.625 inch x Length 325 mm<br>Coating : Xylan Coated  | 300 SET                          | 24.04.2024                    |
| 00100             | सामग्री सं./ Material Number :- 350000000000080695<br>SI No. 10 Studs & Nuts & Washers<br>सामग्री वर्णन/Material Description :Flange Size (inch): 6.625"<br>Rating : #1500   | 300 SET                          | 24.04.2024                    |

| क्र सं.<br>SL.No. | सामग्री / सेवा विवरण<br>Material / Service Details | मात्रा / इकाई<br>Quantity / unit | आपूर्ति तिथि<br>Delivery Date |
|-------------------|--|----------------------------------|-------------------------------|
|-------------------|--|----------------------------------|-------------------------------|

Material : Stud:- ASTM A 193 Gr. B7M  
Nut:- ASTM A 194 Gr. 2HM  
Size of stud : Diameter 1.375inch x Length 265 mm  
Coating : Xylan Coated

नियम और शर्तें : भाग ए में लिखी हुई और इतर संलग्नपत्रे इस निविदा एक अभिन्न अंग हैं। हमें आशा है की, हमें प्रतियोगित्मिक और उचित प्रस्ताव इस निविदा के लिए प्राप्त होगा।  
Terms & Conditions as indicated in Part A of this tender and other enclosures / annexures form an integral part of this tender document. We look forward to receive your most competitive and reasonable offer against this Tender.

माझगाँव डॉक शिपबिल्डर्स लिमिटेड के लिए /For Mazagon Dock Shipbuilders Ltd

# **Mazagon Dock Shipbuilders Limited**

## **Open tender** **Two bid system**

### **ADDITIONAL TERMS AND CONDITIONS (ATC)**

#### **TENDER ENQUIRY FORM (TEF)**

**DIVISION: SUBMARINE & HEAVY ENGINEERING**  
**DEPARTMENT- COMMERCIAL (EAST YARD)**

MAZAGON DOCK SHIPBUILDERS LIMITED (MDL), Mumbai India, a premier Warship building, Ship repair, Submarine Construction & Refits and Heavy Engineering Company owned by Government of India under Ministry of Defence.

**Issue of E - Tender Enquiry Document:** This e-tender enquiry can be downloaded from our E-procurement website <http://eprocaremdl.nic.in>. To login and quote against this e-tender on E-procurement portal, bidders should have Digital Signature Certificate (DSC). The details of DSC are available on the MDL website.

**Tender opening:** Technical bid (PART-I) will be opened immediately after the tender closing date and time through e-procurement portal. Bidders can view details of quotation received against tender after tender opening on e-procurement website.

**Price bid opening:** Similarly after completion of Technical scrutiny/evaluation, price bid (PART-II) opening will be done and intimation will be forwarded to Techno-Commercially accepted bidders. Bidders can view the details of price bid opening against the tender on e-procurement web site.

**SUBJECT: - PROCUREMENT OF FASTENERS FOR FLANGES FOR PART REPLACEMENT PIPELINE PROJECT (PRPP) FOR ONGC.**

**1. Description:**  
**PROCUREMENT OF FASTENERS FOR FLANGES FOR PART REPLACEMENT PIPELINE PROJECT (PRPP) FOR ONGC.**

**Note:**

**i) There should be provision for 10% increase / decrease in quantity and the quoted unit prices to remain fixed(unchanged) for the same.**

Provisions for 10% increase/decrease in quantity" is as under:

- 10% increase in quantity will be absorbed in the same PO price. No additional amount will be paid to vendor.
- In case of 10% decrease in quantity, amount equivalent to 10% short/less material will be deducted from the vendor amount.

**ii) For fasteners 01 Set contains 01 No Stud, 02 Nos Nuts & 02 Nos Washers**

**iii) Studs & Nuts shall be coated with 40 Micron Thick Xylan (PTFE). Colour of coating shall be RED.**

| SR NO. | Material /service details                                 | QTY | Unit |
|--------|---|-----|------|
| 10     | Material Number: -350000000000080685<br>Material group: - | 400 | SET  |

|    |  |      |     |
|----|--|------|-----|
|    | 1000000 - MISC ITEMS (On charge off basis)<br>Material Details: -<br>Flange Size (inch): 16"<br>Rating: #1500<br>Material: Stud: - ASTM A 320 Grade L43<br>Nut: - ASTM A 194 Gr. 7<br>Size of stud: Diameter 2.5-inch x Length 470 mm<br>Coating : Xylan Coated  |      |     |
| 20 | Material Number: -350000000000080686<br>Material group: -<br>1000000 - MISC ITEMS (On charge off basis)<br>Material Details: -<br>Flange Size (inch): 16"<br>Rating: #900<br>Material: Stud: - ASTM A 193 Gr. B7M<br>Nut: - ASTM A 194 Gr. 2HM<br>Size of Stud: Diameter 1.625-inch x Length 290 mm<br>Coating : Xylan Coated  | 1500 | SET |
| 30 | Material Number: -350000000000080687<br>Material group: -<br>1000000 - MISC ITEMS (On charge off basis)<br>Material Details: -<br>Flange Size (inch): 14"<br>Rating: #1500<br>Material: Stud: - ASTM A 193 Gr. B7M<br>Nut: - ASTM A 194 Gr. 2HM<br>Size of stud: Diameter 2.25-inch x Length 425 mm<br>Coating : Xylan Coated  | 400  | SET |
| 40 | Material Number: -350000000000080689<br>Material group: -<br>1000000 - MISC ITEMS (On charge off basis)<br>Material Details: -<br>Flange Size (inch): 14"<br>Rating: #1500<br>Material: Stud: - ASTM A 193 Gr. B7M<br>Nut: - ASTM A 194 Gr. 2HM<br>Size of stud: Diameter 2.375-inch x Length 425 mm<br>Coating : Xylan Coated | 400  | SET |
| 50 | Material Number: -350000000000080690<br>Material group: -<br>1000000 - MISC ITEMS (On charge off basis)<br>Material Details: -<br>Flange Size (inch): 12.75"<br>Rating: #1500<br>Material: Stud: - ASTM A 193 Gr. B7M<br>Nut: - ASTM A 194 Gr. 2HM<br>Size of stud Diameter 2-inch x Length 385 mm<br>Coating : Xylan Coated   | 1200 | SET |
| 60 | Material Number: -350000000000080691<br>Material group: -<br>1000000 - MISC ITEMS (On charge off basis)<br>Material Details: -<br>Flange Size (inch): 12.75"<br>Rating: #1500<br>Material: Stud: - ASTM A 193 Gr. B7M<br>Nut: - ASTM A 194 Gr. 2HM<br>Diameter 1.375-inch x Length 385 mm                                      | 1000 | SET |



|     |  |      |     |
|-----|--|------|-----|
|     | Coating : Xylan Coated   |      |     |
| 70  | Material Number: -350000000000080692<br>Material group: -<br>1000000 - MISC ITEMS (On charge off basis)<br>Material Details: -<br>Flange Size (inch): 12.75"<br>Rating: #900<br>Material: Stud: - ASTM A 193 Gr. B7M<br>Nut: - ASTM A 194 Gr. 2HM<br>Size of stud: Diameter 1.375-inch x Length 255 mm<br>Coating : Xylan Coated | 2000 | SET |
| 80  | Material Number: -350000000000080693<br>Material group: -<br>1000000 - MISC ITEMS (On charge off basis)<br>Material Details: -<br>Flange Size (inch): 10.75"<br>Rating: #900<br>Material: Stud: - ASTM A 193 Gr. B7<br>Nut: - ASTM A 194 Gr. 2H<br>Size of stud: Diameter 1.375-inch x Length 235 mm<br>Coating : Xylan Coated   | 800  | SET |
| 90  | Material Number: -350000000000080694<br>Material group: -<br>1000000 - MISC ITEMS (On charge off basis)<br>Material Details: -<br>Flange Size (inch): 8.625"<br>Rating: #1500<br>Material: Stud: - ASTM A 193 Gr. B7M<br>Nut: - ASTM A 194 Gr. 2HM<br>Size of stud Diameter 1.625-inch x Length 325 mm<br>Coating : Xylan Coated | 300  | SET |
| 100 | Material Number: -350000000000080695<br>Material group: -<br>1000000 - MISC ITEMS (On charge off basis)<br>Material Details: -<br>Flange Size (inch): 6.625"<br>Rating: #1500<br>Material: Stud: - ASTM A 193 Gr. B7M<br>Nut: - ASTM A 194 Gr. 2HM<br>Size of stud: Diameter 1.375inch x Length 265 mm<br>Coating : Xylan Coated | 300  | SET |

Bidders shall confirm that the Scope of Supply and functional specifications at **Enclosure** is fully understood by them on their letterhead.

**Note:** - Any technical query related to SOW shall be forwarded to following:

Mr. Rupesh Mahajan, Chief Manager (PLG-EY).

E-mail: [rpmahajan@mazdock.com](mailto:rpmahajan@mazdock.com)

**Phone - 022-2376 3604**

**Or**

Mr Prashant Patil, Chief Manager (D-EY)

E-mail: [pbpatil@mazdock.com](mailto:pbpatil@mazdock.com)

**Phone - 022-2376 3604**

## 2. Instructions to the bidder:

- a. Bidder should submit all documents strictly through e-portal only. Physical copy of the bid will not be accepted except for the physical copies of documents requested in the tender.
- b. In case of supply/services of duplicate / spurious / substandard items by the firm, MDL will resort to prosecution of the firm by legal action with all the stringent measures against the firm for supplying such items which had led to delay of the project of national importance and has endangered the national security. The firm will also be blacklisted in MDL & will be debarred from quoting in future MDL tenders and the same will be intimated to all other public sector undertakings and other Government organization.
- c. Bidders are requested to ensure that only relevant documents complete in all respect as indicated in the tender should be attached with their offer. The first page of every uploaded set of scanned document shall be an index of its contents. In case the offers received against this tender are more than 20, no opportunity will be extended for submission of deficient documents after opening of bids. The evaluation of the offers will be carried out and bidders will be qualified based on the documents received along with their offer.
- d. Delivery date mentioned in the RFQ/Tender is tentative. However, bidders have to follow delivery schedule as per purchase order. Non-compliance of the same beyond the contractual terms may lead to imposition of liquidated damages or cancellation of contract/ Purchase order.
- e. Where requests are made by bidders with reasons for extension of the tender closing date provided such an extension will not adversely affect the project schedule and bidders are instructed for submission of such request in the concerned commercial department at least 2 days in advance excluding the day of tender closing date, amendment to the tender enquiry may be issued.
- f. Any participating firm which has been debarred/blacklisted by Central/State Governments or by any entity controlled by Central/State Governments from participating in any of their project, as on date of submission of Tender, shall not be eligible to submit the Tender.

### **3. Pre-Qualification Criteria(PQC):**

#### **a) Technical PQC:**

The bidder shall furnish supply references in recent 05 with supporting documents/PO Copies/WCC/ letter from customer as a proof for sub-sea pipeline, sour & non-sour application or similar project.

#### **b) Commercial PQC:**

- i. The average annual financial turnover of 'The bidder' during the last three years, ending 31st March (or any other year ending followed in relevant country) of the previous financial year excluding the calendar year of tendering should be at **INR 45,00,000/-** as per the annual report (audited balance sheet and profit and loss account) of the relevant period, duly authenticated by a Chartered Accountant/Cost Accountant in India or equivalent in relevant countries.
- ii. Bidders Shop and establishment registration certificate or registration certificate from registrar of firms or certificate of incorporation from Registrar of Companies (Not required for permanent registered vendors with MDL).

#### **c) Applicability to 'Make in India':**

Bidders (manufacturer or principal manufactures of authorised representative) who have a valid/approved on going 'Make in India' agreement/program and who while meeting all other criteria above, except for any or more of sub-criteria in Experience and Past Performance above, would also be considered to be qualified provided:

- (i) their foreign 'Make-in-India' associates meet all the criteria above without exemption, and

- (ii) the Bidder submits appropriate documentary proof for a valid/approved on going 'Make in India' agreement/program.
- (iii) the bidder (manufacturer or principal of authorised representative) furnishes along with the bid a legally enforceable undertaking jointly executed by himself and such foreign Manufacturer for satisfactory manufacture, Supply (and erection, commissioning if applicable) and performance of 'The Product' offered including all warranty obligations as per the general and special conditions of contract.

**d) Authorized Representatives:**

Bids of bidders quoting as authorised representative of a principal manufacturer would also be considered to be qualified, provided:

- i) their principal manufacturer meets all the criteria above without exemption, and
- ii) the principal manufacturer furnishes a legally enforceable tender-specific authorisation in the prescribed form (Deed of Agreement) assuring full guarantee and warranty obligations and all contractual obligation as per the tender terms and conditions; and
- iii) the bidder himself should have been associated, as authorised representative of the same or other Principal Manufacturer for same set of services as in present bid (supply, installation, satisfactorily commissioning, after sales service as the case may be) for same or similar 'Product' for past three years.

**e) Joint Ventures and Holding Companies:**

Credentials of the partners of Joint ventures cannot (repeat cannot) be clubbed for the purpose of compliance of PQC in supply of Goods/Equipment, and each partner must comply with all the PQC criteria independently. However, for the purpose of qualifying the Financial Standing Criteria, the Financial Standing credentials of a Holding Company can be clubbed with only one of the fully owned subsidiary bidding company, with appropriate legal documents proving such ownership.

**f) The condition of prior turnover and prior experience is relaxed only for all Start-ups recognised by Department for Promotion of Industry and Internal Trade (DPIIT) subject to meeting of quality & technical specifications. Start-ups may be MSMEs or otherwise. Start-ups shall be given relaxation in prior turnover and prior experience as specified under:**

- i) Start-ups shall be given 100% relaxation in prior turnover and prior experience subject to meeting of quality & technical specifications.
- ii) If L-1 bidder is Start-up, then Start-up firms are eligible for ordering of 100% of tendered quantity.

Note: The above provisions are subject to meeting purchase preference policies which will prevail over above provision.

**g) MSEs shall be given 100% relaxation of prior turnover and prior experience subject to meeting of quality and technical specifications.**

**Note:** Bidders need to upload / submit supporting documentary evidence in support of the Pre-Qualification Criteria Viz. Work / Purchase Order, Work Completion Certificate/ Proof of payment with Tax Invoice / Store Receipt and Acceptance Report or any other evidence that confirms that the work is completed which is issued by the party for whom the work is done. HOD-C (East Yard) or TNC has a right to verify / cause verification of authenticity of the said documents whenever felt necessary.

**4. Earnest Money Deposit (EMD) / Bid Security: INR 3,00,000/-**

EMD shall be obtained by way of NEFT/ Demand Draft / Pay order / Bank Guarantee / Insurance Security Bond / e-Bank Guarantee in favour of Mazagon Dock Shipbuilders Limited, Mumbai from the

list of Banks approved by SBI / Canara Bank published on MDL website. Crossed DD / Pay Order issued by Co-operative banks however may be considered to be accepted and the bid would be considered accordingly.

Bids / Offers without EMD/Bid Bond along with Part-I bid will not be considered. EMD of unsuccessful bidders will be returned after finalization of the tender and shall be interest free.

Firm should submit the original EMD in closed envelope (Sealed), Super scribed as EMD/BID Bond for Bid No....., due date, time, and addressed to, HOD (EY-Commercial Dept.), Alcock Yard, MAZAGON DOCK SHIPBUILDERS LIMITED, Dock Yard Road, Mumbai, 400010, INDIA, and should be Submitted at below address within 7 working days from the Bid closing date.

HOD (Commercial – EY),  
4th floor, North Block, SSA Work Shop, Office building, Alcock Yard,  
MAZAGON DOCK SHIPBUILDERS LIMITED,  
Dockyard Road,  
Mumbai-400010, India.

Timely submission of the original EMD is the responsibility of the bidders and no reasons / excuses in this regard will be entertained by MDL. Original EMD reached after 7 working days from tender closing date & time will render the e-bid (submitted by bidder) liable for rejection.

Exemption from submission of EMD / BID Bond:

Following bidders shall be exempted from submission of EMD/Bid Bond:

- i) State & Central Government of India Departments & Public Sector Undertakings.
- ii) Firms registered with MDL. To qualify for EMD exemption, firms should necessarily submit valid copy of the Registration Certificate issued by MDL, for the items for which the offer is being submitted. Firms in the process of obtaining MDL registration will not be considered for EMD exemption.
- iii) Micro and Small Enterprises who are manufacturer or Service Provider and give specific confirmation to this effect at the time of bid submission and whose credentials are validated online through Udyam Registration (as validated by Government from time to time) and through uploaded supporting documents.
- iv) Firms registered with NSIC under its "Single Point Registration Scheme". (Exemption will apply only to items/services for which they are registered. To qualify for EMD exemption, firms should necessarily submit valid copy of the Registration Certificate along with the list of items / services for which they are registered, as issued by NSIC, in Part-I offer / bid. Firms in the process of obtaining NSIC registration will not be considered for EMD exemption.
- v) Start-ups as recognized by Department of Industrial Policy and Promotion (DIPP).
- vi) The recognised institutes such as VJTI/IIT.
- vii) Common/Deemed DPSU registered vendors qualify for EMD exemption. Such firms shall submit valid copy of the registration certificate issued by DPSUs (other than MDL) for the items / services for which the offer is being submitted in Part-I offer/bid. Firms in process of obtaining registration in other DPSUs will not be considered for EMD exemption.
- viii) Green Channel Status vendors qualify for EMD exemption. Such firms shall submit valid copy of the Green channel certificate issued by MoD for the items for which the offer is being submitted in Part-I offer/bid. Firms in process of obtaining this certificate will not be considered for EMD exemption.

#### **5. Forfeiture of EMD:**

EMD shall be forfeited in the following cases:

- i) Bidder withdraws, amends, impairs or derogates from the tender, agreed conditions of TNC /PNC in any respect within the period of validity of his offer.
- ii) Non-acceptance of order.

**6. Validity Period of Bid:**

Bid shall remain valid for a period of not less than **180 days** after the deadline date for bid submission.

**7. Delivery Schedule/period:**

Delivery shall start from 02 weeks and should be completed within 04 weeks from the date of PO.

**8. Receipt of Bids / Offers:**

Bidder should submit all documents strictly through e-portal only. Physical copy of the bid will not be accepted except for the physical copies of documents requested in the tender.

**9. Submission of Revised Bids:**

The bidders if so desire may modify their bids prior to the closing date and time of the tender enquiry. However, it shall be the responsibility of the bidder to ensure that they have submitted the revised bid.

**10. Bid Rejection Criteria:****i) Categorical Rejection Criteria**

The following conditions / deviations are non-negotiable and therefore, any bid falling under these conditions / deviations shall be summarily rejected. Bidders to note that they shall not be provided any opportunity to rectify these conditions / deviations post bid opening:

- a) Bidders who are debarred under PPP MII order 2017, CPPP including Tender holiday issued by MDL.
- b) Bids received without EMD (other than those who are exempted from payment of EMD).

**ii) Liable for Rejection Criteria:**

- a) Non-compliance/non-acceptance to any of the terms and conditions of the tender shall render the bid liable for rejection. Equal time and opportunity for submission of deficient technical documents and clarification shall be given to the bidders. Bidders are required to submit such documents / clarifications within the duration / date stipulated by MDL failing which their bids will be rejected.
- b) Bids received without Integrity Pact duly signed by the bidder on each page.

**11. OEM/Authorised Dealer/Agents of Supplier:**

Except in case of Commercially-Off-The-Shelf (COTS) items, when a firm sends quotation for an item manufactured by some different company, the firm is also required to attach, in its quotation, the manufacturer's authorisation certificate and also manufacturer's confirmation of extending the required warranty for that product. This is necessary to ensure quotation from a responsible party offering genuine product, also backed by a warranty obligation from the concerned manufacturer. In the tender, either the manufacturer or its authorised dealer can be considered as valid bidders. In case of large contracts, especially capital equipment, the manufacturer's authorisation must be insisted upon on a tender specific basis, not general authorisation/dealership, by so declaring in the bid documents clearly. In cases where the manufacturer has submitted the bid, the bids of its authorised dealer will not be considered and EMD will be returned. And in case of violations, both infringing bids will be rejected.

There can be only one bid from the following:

- i) The principal manufacturer directly or through one Indian agent on his behalf; and
- ii) Indian/foreign agent on behalf of only one principal.

**12. Guarantee & warranty:**

Warranty period shall be for 12 months from the date of supply. Valid warranty certificate must be submitted. During this period, all defect arising out of defective material and faulty workmanship will be rectified by repairing or replacing part or whole material as necessary free of charge on delivery basis. Any consequential damage/defect or loss of item due to poor workmanship/poor material quality/ negligence etc. attribute to the bidder to be rectified / replaced by the bidder free of cost.

**Note:**

Any material, equipment, infrastructure facility, required directly or indirectly for completing the subject work, as per the scope of work & drawing given, if not mentioned in MDL's scope, has to be arranged by the subcontractor without any extra cost to MDL.

In case of the performance of the contractor is not satisfactory MDL reserves the right to cancel the order and lift the material from contractor.

### **13. Performance Security (Performance Bank Guarantee & Security Deposit):**

Successful bidders need to submit Performance Bank Guarantee (PBG) cum Security Deposit (SD) for an amount of 5% of the value of the contract (excluding taxes & duties). Performance security may be furnished in the form of NEFT/ Demand Draft / Pay order / Bank Guarantee / Insurance Security Bond / e-Bank Guarantee in favour of Mazagon Dock Shipbuilders Limited, Mumbai from the list of Banks approved by SBI / Canara Bank published on MDL website. Performance Security is to be furnished within **25 days** after notification of the award of contract and it should remain valid for a period of **60 (sixty)** days beyond the date of completion of all contractual obligations of the supplier, including warranty obligations.

### **14. Non submission of Performance Security:**

- i. In case of failure to submit performance security by the supplier within 25 days of transmission / notification of order by any mode, EMD (if available) will be forfeited and MDL reserves the right to cancel the order and invoke the risk purchase clause. If it is established that the contractor has failed to comply with the Guarantee/warranty obligations, the PSBG will be encashed by MDL. MDL's decision in this regard shall be final and binding on the supplier / contractor.
- ii. In cases where the supplier / contractor has not submitted the PS and already commenced supply / services, Performance security will be retained from the bills, if any. In such case, interest will be recovered for the period starting from 26th day of transmission / notification of order/contract by any mode and amount involved at the relevant rate of interest for that quarter. For Indian suppliers, it will be SBI BPLR plus 2%.

### **15. Forfeiture of Performance Security:**

Forfeiture of Performance Security shall be done in case of non-performance of agreed terms and or default/breach by bidder / supplier with application of risk purchase provisions or tender holiday where applicable.

### **16. Free issue materials:**

- i) In cases where the materials such as MS / AL sheets, Steel, Components etc. are required to be issued free of cost to the Supplier for Galvanizing, Heat treatment, Fabrication, Fitment etc. on returnable basis, the Supplier shall furnish Bank Guarantee equivalent to the value of materials supplied by MDL free of cost for works undertaken outside MDL premises.
- ii) ~~Undertaking needs to be submitted on the Letterhead in case of Foreign Firm from their Authorised Signatory.~~ In case of Indigenous firm, Indemnity Bond on INR 500 Non-Judicial Stamp Paper to be submitted.
- iii) In cases such as low value contracts involving high value materials etc., the submission of Indemnity Bond and provision of insurance cover with MDL as the beneficiary may be acceptable. For any items that are being taken out for repairs during warranty period then a separate BG equivalent to the value of item need not be submitted if valid PBG is available to cover the cost of item. Such Bank Guarantee / Indemnity Bond / Insurance Cover shall be valid up to the execution of the contract / delivery of material, inspected /accepted and receipt at MDL.
- iv) The Free Issue Material can be issued against holding of equivalent amount from the payment due to the firm.
- v) On completion / execution of the Order / Contract as per approved drawings and plans such as nesting plan, this should be returned within a period of 15 days from the date of receipt of finished

product and leftover material in MDL OR any other location specified in the order along with the certified statement of reconciliation of MDL's property showing following details;

- a. Quantity of material issued.
- b. Quantity of materials consumed / vis-a vis percentage of job completed.
- c. Quantity of material returned to respective stores / held in stock by Contractor at his end.
- d. Actual quantity wasted / scrapped as a by-product of process as against stipulated amount.

vi) Supplier / Contractor shall also furnish undertaking regarding protection of intellectual property rights and that issued design drawing will be returned without reproducing and retaining any copies at their end.

#### **17. Pricing:**

- i) Bidder shall quote the prices in the Rate Sheet Format provided in e-tender.
- ii) The quoted prices shall remain firm and fixed during the currency of the order / contract unless agreed otherwise by MDL.
- iii) The reference price, if any, indicated anywhere in the tender document against each line item is only notional and has no commercial relevance. Therefore, such reference price should not be considered as guidance price and the bidders shall quote their price based on their costing and pricing policies.

#### **iv) There should be provision for 10% increase / decrease in quantity and the quoted unit prices to remain fixed(unchanged) for the same.**

Provisions for 10% increase/decrease in quantity" is as under:

- 10% increase in quantity will be absorbed in the same PO price. No additional amount will be paid to vendor.
- In case of 10% decrease in quantity, amount equivalent to 10% short/less material will be deducted from the vendor amount.

#### **18. Firm Price / Price Variation:**

Prices quoted by bidder shall remain firm and fixed during the period of the contract and not subject to variation on any account.

#### **19. Payment Terms:**

**No Advance in any manner will be paid to the Supplier / Bidder / Vendor / Contractor.**

100% payment of line items will be made against complete (100%) supply of the line items of the order and as reduced by any deductibles and/or the amount leviable towards liquidated damages, if any and after including statutory taxes, duties and levies as applicable may be payable through RTGS/NEFT within 15 days for actual quantities of work executed and on submission of relevant documents as mentioned below: -

- i) Set of Original + 2 Copies of signed Tax Invoice showing item / activity wise prices as per the Contract / Order to be submitted to Commercial Department, East Yard.liquidated
- ii) Set of Original+2 copies of Warranty Certificate as per Enclosure.
- iii) Set of Original+2 copies of PSBG as per the Enclosure.
- iv) Signed copy of Material acceptance report by MDL-User not below the rank of chief manager.

#### **Note:**

Wherever GST is applicable, payment will be released against e-Invoice, or Invoice accompanied with vendor's self-declaration that

"We do not fall under the category of registered persons notified under Rule 48(4) of the Central GST Rules, 2017 and we are not required to comply with e-Invoicing provisions under GST Act, as our aggregate turnover in any preceding financial year from 2017-18 onwards has not exceeded Rs. 5 Cr. as per GST Act."

**20. Trade Receivable Discounting System (TReDS) for MSEs:**

- a) TReDS is a digital platform to help MSMEs to address their financial needs for facilitating the financing of trade receivables from buyers, through multiple financiers. TReDS is governed by the Reserve Bank of India under the Payment and Settlement Systems Act, 2017 and the Factoring Regulations Act, 2011. Under the TReDS initiative, at present, RBI has given licenses to three participants (A. TReDS Ltd, RXIL, M1 Xchange). MDL is registered for TReDS online platform with A. TReDS Ltd, and M1Xchange to facilitate payments to MSMEs through TReDS. At TReDS, auctioning of invoices at competitive and transparent environment is done by financiers based on Buyer's credit profile.
- b) MSE bidders desirous to receive payments through TReDS platform may avail the facility if they are already registered on TReDS platform or by registering on any one of the service provider. Contact details of TReDS platform service providers are to be indicated. MSE bidders upon successful delivery shall submit their invoices along with the mandated enclosures at MDL, central receipt section. MSE vendors, desirous to receive payments through a particular TReDS platform must submit their TReDS details along with the invoice at MDL, central receipt section. Upon receipt and acceptance of the supplied material and receipt of invoices with the mandated enclosures, MDL shall process the invoice for payment on that particular TReDS platform. Any unfinanced invoices / invoices of MSE bidders seeking payment from MDL directly shall be processed as per the standard payment terms agreed in PO / contract.

**21. Taxes and Duties:**

- i) Bidders must quote the amounts of Taxes and Duties as applicable, separately, duly indicating the base amount(s) and the applicable rate(s), under each of the heads indicated above. Wherever Exemption Certificates are issued, no liability for payment of taxes and duties arises and hence taxes and duties shall not be reimbursed / allowed.
- ii) Supplier / contractor will not be entitled to any increase in rate of taxes occurring during the period of extended delivery completion schedule if there is delay in supplies / completion attributed to him.
- iii) However, if there is a decrease in taxes, the same must be passed on to MDL.
- iv) Wherever all-inclusive prices are quoted by the Tenderer(s) without bifurcation of tax elements, no escalation can be considered in respect of any variations in statutory levies arising subsequently because of the absence of the required base figures in the purchase order / contract.

**Note:**

- a) GST shall be payable extra as quoted and agreed as per GST Laws.
- b) In case of purchases of goods/services from unregistered dealers under GST Laws, GST will be paid by MDL under reverse charge mechanism.
- c) Benefits from reduction in rate of tax/ITC is required to be passed on to consumer. Where "applicable GST" has been quoted as extra, Goods and service providers (except unregistered dealers under GST Law) have to submit declaration that they have complied with 'Anti profiteering clause' under GST Law. Such declaration be given in technical bid.
- d) If the vendor is registered under GST, vendor shall mention the HSN code for goods and/or services in their tax invoice, etc. These codes must be in accordance with GST Laws and responsibility of specifying correct HSN codes for goods and/or services is that of the vendor. MDL shall not be responsible for any error in HSN code for goods and/or services specified by supplier / contractor. Supplier /Contractor shall pay penalty and/ or interest imposed on MDL or any loss due to delay in availing ITC by MDL or any loss of ITC to MDL due to errors by vendors at any stage. MDL reserves right to recover any such interest, penalty or loss from any amount due to supplier /contractor or otherwise.
- e) In case, MDL is unable to avail ITC, supplier/contractor at their own cost shall rectify the shortcoming in the returns to be filed immediately thereafter. Further, if the ITC is delayed /



denied to MDL / reversed subsequently as per GST Laws due to non / delayed receipt of goods and / or services and / or tax invoice or expiry of timelines prescribed in GST Laws for availing ITC, non-payment of taxes or non-filing of returns or any other reason not attributable to MDL, supplier /contractor shall pay any loss of amount along with interest and penalty on MDL under GST Laws for the number of days the ITC was delayed. If the short coming is not rectified by supplier/contractor and MDL ends up in reversal of credits and / or payments, supplier /contractor is fully liable for making good all the loss incurred by MDL. MDL reserves right to recover any interest, penalty or loss from any amount due to supplier /contractor or otherwise.

- f) If the vendor is registered under GST, the GST registration number (15 digit GSTIN) issued by GoI shall be mandatorily provided by the vendor. Vendor having multiple business verticals within state / at multiple states with separate GST registration numbers shall forward GSTIN of only that vertical which is involved in supply of goods and/or services. MDL GSTIN is 27AAACM8029J1ZA and vendor shall mention the same while invoicing and avoid any data entry error on GST portal.
- g) If the vendor is registered under GST; Vendor shall ensure timely submission of invoice as per the provisions / requirement / timeline promulgated by GOI in relation to GST Law with all required supporting documents to enable MDL to avail input tax credit promptly. The vendors invoice inter alia should contain GSTIN of vendor, GSTIN of MDL (i.e.27AAACM8029J1ZA), GST tax rate separately, HSN code wise goods or services, place of supply, signature of vendor, etc. Original invoice needs to be submitted to Bill Receipt Centre at MDL gate, and a copy of the invoice should be given to the goods receiving section (GRS).
- h) If the vendor is registered under GST, vendor shall file all applicable returns under GST Laws in the stipulated time and any losses of tax credit to MDL arising due to delay in filing will be recovered from their invoice wherever MDL is eligible to avail tax credit. Any default towards payment of tax and / or uploading of monthly returns by supplier/contractor, MDL retains right to withhold payments towards tax portion until the same is corrected and complied by the supplier/contractor with the requirement of GST along with satisfactory evidence.
- i) The rate sheet enclosed with the tender will indicate the rates to be entered under each head wherever applicable. Bidders must clearly mention the applicable taxes and duties. The item-wise rates (Inclusive of packing forwarding, freight & insurance) quoted in the rate sheet should exclude taxes and duties. Bidder should indicate GST rates as applicable separately under each of the head in the same Rate sheet, which will be paid extra based on tax invoice to the extent applicable. The GST will be applicable on total basic rate of each item (Inclusive of packing forwarding, freight & insurance).

## **22. E-invoice:**

The vendors, whose aggregate turnover in any preceding financial year from FY 2017-18 onwards, exceeds INR 5 crore as per GST Act or as applicable from time to time, will have to issue an e-Invoice with a Quick Response (QR) code and Invoice Registration No.(IRN), It is important to note that MDL will not be entitled for Input Tax Credit (ITC)/GST on a vendor Invoice which is not compliant with the above e-Invoice notification. Wherever GST is applicable, payment will be released against e- Invoice, or Invoice accompanied with vendor's self-declaration that "we do not fall under the category of registered persons notified under Rule 48(4) of the Central GST Rules, 2017 and we are not required to comply with e-Invoicing provisions under GST Act, as our aggregate turnover in any preceding financial year from 2017-18 onwards has not exceeded INR 5 crore as per GST Act".

## **23. Ranking of Bids:**

All line items are inseparable.

The comparison of the responsive tenders shall be on total outgo on Least Cost Net of Credit Basis (LCNC), for the procurement to be paid to the supplier or service provider, including all elements of costs, duties, levies, freight, insurance etc. excluding GST (where ITC is available). Therefore, it should normally be on the basis of CIF/ FOR destination basis, duly delivered, commissioned, as the case may be.

## **24. Purchase Preference to Micro and Small Enterprises(MSEs):**

Micro and Small Enterprises (MSEs) registered under Udyam Registration or as directed by government are eligible to avail the benefits under the policy. This Policy is meant for procurement of only goods produced and services rendered by MSEs. Traders/Distributors/Sole Agents/Works Contract are excluded from the purview of the policy. MDL has right to place order on MSE Manufacturer and MSE Service Provider meeting following criteria:

- a) In tender, participating Micro and Small Enterprises (MSE) quoting price within price band of L1+15 (fifteen) per cent shall also be allowed to supply a portion of requirement by bringing down their price to L1 price in a situation where L1 price is from someone other than a MSE and such MSE shall be allowed to supply up to 25(twenty-five) per cent of total tendered value. The 25(twenty-five) per cent quantity is to be distributed proportionately among these bidders, in case there are more than one MSEs within such price band.
- b) Within this 25% (Twenty Five Percent) quantity, a purchase preference of four (4) per cent is reserved for MSEs owned by Scheduled Caste (SC)/ Scheduled Tribe (ST) entrepreneurs and three (3) percent is reserved for MSEs owned by women entrepreneur (if they participate in the tender process and match the L1 price). However, in event of failure of such MSEs to participate in tender process or meet tender requirements and L1 price, four percent sub-target for procurement earmarked for MSEs owned by SC/ST entrepreneurs and three (3) percent earmarked to women entrepreneur will be met from other MSEs. . MSEs would be treated as owned by SC/ ST entrepreneurs:
  - i) In case of proprietary MSE, proprietor(s) shall be SC /ST;
  - ii) In case of partnership MSE, the SC/ ST partners shall be holding at least 51% (fifty-one percent) shares in the unit;
  - iii) In case of Private Limited Companies, at least 51% (fifty-one percent) share shall be held by SC/ ST promoters.
- c) If subcontract is given to MSEs, it will be considered as procurement from MSEs.
- d) In case of tender item cannot be split or divided, etc. the MSE quoting a price within the band L1+15% may be awarded for full/ complete supply of total tendered value to MSE, considering the spirit of the Policy for enhancing Govt. Procurement from MSEs.
- e) In respect of items reserved for MSE-Manufacturers, extant guidelines shall be followed. Presently Circular No. S.O. 581(E) dated 23.03.2012 is applicable. The latest list may be seen from the website of the MSME Ministry.

## **25. Purchase Preference to Make in India 2017:**

The Government of India has issued revised Public Procurement (Preference to Make in India) order 2017 on 16th Sep 2020 as part of its policy to encourage "Make in India" and promote manufacturing and production of goods and services in India with a view to enhancing income and employment. Subject to the provisions of this order and to any specific instructions issued by Nodal Ministry or in pursuance of this order, Purchase Preference shall be given to local suppliers in all the procurements undertaken by MDL in the manner specified below.

### **Aspects of 'Preference to Make in India':**

- a) "Local content" means the amount of value added in India which shall be the total value of item (goods, services or works or their combination) under procurement (excluding net domestic indirect taxes) minus the value of imported content in the item (including all customs duties) as a proportion of the total value in percent. Different definition of Local Content may be specified by the Nodal Ministry for items assigned to them, which will prevail over above.

Note: The local content can be increased by vendors through partnerships, cooperation with local companies, establishing production units in India or Joint Ventures (JV) with Indian suppliers, increasing the participation of local employees in services and training them.

- b) "Class-I Local Supplier" means a supplier or service provider, whose goods, services or works offered for procurement, meets the minimum local content as prescribed for 'Class-I local supplier' under this Order.
- c) "Class-II Local Supplier" means a supplier or service provider, whose goods, services or works offered for procurement, meets the minimum local content as prescribed for 'Class-II local supplier' but less than that prescribed for 'Class-I local supplier' under this Order.
- d) "Non-Local Supplier" means a supplier or service provider, whose goods, services or works offered for procurement, has local content less than that prescribed for 'Class-II local supplier' under this Order.
- e) "L1" means the lowest tender or lowest bid or lowest quotation received in a tender, bidding process or other procurement solicitation as adjudged in the evaluation process as per the tender or other procurement solicitation.
- f) "Margin of Purchase Preference" means the maximum extent to which the price quoted by a "Class-I Local Supplier" may be above the L1 for the purpose of purchase preference. The margin of purchase preference shall be 20% which is to be indicated in tender.

Note: Price/s of all Class I local supplier/s in a tender is more than 20% of L1's price no purchase preference shall be applicable.

- g) "Nodal Ministry" means the Ministry or Department identified pursuant to the said Order in respect of a particular item of goods or services or works.
- h) "Procuring entity" means a Ministry or department or attached or subordinate office of or autonomous body controlled by, the Government of India and includes Government companies as defined in the Companies Act.

Note: Mazagon Dock Shipbuilders Limited (MDL) shall be a procuring entity.

- i) "Works" means all works as per Rule 130 of GFR-2017 and will also include "turnkey works", Engineering, Procurement and Construction (EPC) contracts.
- j) "Services" includes System Integrator (SI) contracts among other services.
- k) **Eligibility of Suppliers to bid in a tender**
- i) In procurement of all goods, services or works in respect of which the Nodal Ministry / Department has communicated that there is sufficient local capacity and local competition, only 'Class-I local supplier', as defined under the Order, shall be eligible to bid irrespective of purchase value.
- ii) Both 'Class-I local supplier' and 'Class-II local supplier' shall be eligible to bid in procurements not covered above para (i) and undertaken by procuring entities, except when Global tender enquiry has been issued. In global tender enquiries (GTE), 'Non-local suppliers' shall also be eligible to bid along with 'Class-I local suppliers' and 'Class-II local suppliers'. In procurement of all goods, services or works, not covered above para (i), and with estimated value of purchases less than INR 200 Crore, in accordance with Rule 161(iv) of GFR, 2017, Global tender enquiry (GTE) shall not be issued except with the approval of competent authority as designated by Department of Expenditure. For the cases pertaining to MoD, Defence Secretary will be the competent authority to approve issue of GTE up to INR 200 Crore based on adequate justification as per MoF DoE PP Division ID Note No F.20/36/2020-PPD dtd 28.10.2020.

l) **Special Conditions in GTE Procurements: Agency Commission:**

The amount of Agency Commission, (normally not exceeding five percent) payable to the Indian Agent should not be more than what is specified in the Agency agreement (a certified copy should be submitted along with the bid) between the bidder and the Indian Agent. The Indian Agent will be required to submit a certificate along with their Agency Commission bill, confirming that the

amount claimed as Agency Commission in the bill has been spent/will be spent, strictly to render services to the foreign Principal, in terms of the Agency Agreement. The Purchaser or their authorized agencies and/or any other authority of the Government of India shall have rights to examine the books of the Indian Agent and defects or misrepresentations in respect of the afore indicated confirmation coming to light during such examinations will make the foreign Principal (i.e. the Contractor) and their Indian Agent liable to be banned/suspended from having business dealings with the Purchaser, following laid down procedures for such banning/suspension of business dealings.

- m) DPIIT vide OM No. P-45021/102/2019-BE-II Part (1) (E-50310) dated 04 Mar 2021 has clarified that bidders offering imported products will fall under the category on Non-local suppliers and they cannot claim themselves as Class-I local suppliers / Class-II local suppliers by claiming the services such as transportation, insurance, installation, commissioning, training and after sales service support like AMC / CMC, etc. as local value addition. Hence, bidders offering imported products will be treated as Non-local suppliers.

## 26. Purchase preference:

- a) Purchase preference shall be given to only "Class-I Local Supplier" (Class II Local Supplier are not eligible for purchase preference) in procurements undertaken in the manner specified in the succeeding sub-paras:
- b) The Class-I local suppliers, under PPP-MII Order, participating in any government tender, may or may not be MSEs, as defined under the MSME Act. Similarly, MSEs participating in any government tender, may or may not be Class-I local suppliers. Suppliers may be categorised in following four broad categories for consideration or applicability of purchase preference:

| Category  | Terminology                        |
|---|------------------------------------|
| Supplier is both MSE & Class- I local supplier    | MSE Class-I local supplier         |
| Supplier is MSE but not Class- I local supplier   | MSE but non-Class-I local supplier |
| Supplier is not MSE but is Class-I local supplier | Non-MSE but Class-I local supplier |
| Supplier is neither MSE nor Class-I local         | Non-MSE non-Class-I local supplier |

- c) In the procurement covered by para 23 (K) (i) above (Para 3(a) of PPP-MII Order, 2017) for which Nodal Ministry has notified sufficient local capacity and competition, only Class-I local suppliers are eligible to bid irrespective of purchase value. Hence, Class-II local suppliers or Non-local suppliers, including MSEs which are Class-II local suppliers/ Non-local suppliers, are not eligible to bid. Purchase preference shall be accorded as under:
- i) L-1 is "MSE Class-I local supplier": 100% of the tendered quantity shall be awarded to L-1.
- ii) L-1 is "Non-MSE but Class-I local supplier"(Divisible in nature): Purchase preference shall be given to MSEs as per PPP-MSE Order. Balance quantity be awarded to the L-1 bidder.
- iii) L-1 is "Non-MSE but Class-I local supplier" (Non- Divisible in nature): Purchase preference shall be given to lowest quoting MSE Class-I local supplier as per PPPMSE Order. If lowest quoting MSE Class-I local supplier does not accept the L-1 rates, the next higher eligible MSE Class-I local supplier is to be given purchase preference and so on. 100% of the tendered quantity shall be awarded to MSE Class-I local supplier accepting L-1 rates. If MSE Class-I local suppliers do not accept L- 1 rates, then contract shall be awarded to L-1
- d) In the procurement of goods and services reserved exclusively for procurement from MSEs as per PPP-MSE Order, non- MSEs are not eligible to bid for these items and Purchase preference shall be accorded as under:
- i) L-1 is "MSE Class-I local supplier": 100% of the tendered quantity shall be awarded to L-1

- ii) L-1 is "MSE non-Class-I local supplier"(Divisible in nature): Purchase preference shall be given to MSE Class-I local supplier as per PPP-MII Order. Balance quantity be awarded to L-1 bidder.
  - iii) L-1 is "MSE non-Class-I local supplier" (Non-Divisible in nature): First opportunity shall be given to lowest quoting "MSE Class-I local supplier" for matching L-1 bidder as per PPP-MII Order for 100% of the tendered quantity and if lowest quoting "MSE Class-I local supplier" does not accept the L-1 rates, the next higher eligible "MSE Class- I local supplier" is to be given purchase preference and so on. If all "MSE Class-I local suppliers" decline to accept the L-1 rates, then contract shall be awarded to L-1 for 100% of the tendered quantity.
- e) In the procurement of goods or service which are covered in para 23 (K) (ii) above which are divisible in nature (Para 3A(b) of PPP-MII Order), both MSEs as well as Class-I local suppliers are eligible for purchase preference and the Purchase preference shall be accorded as under:
- i) L-1 is "MSE Class-I local supplier": 100% of the tendered quantity shall be awarded to L-1.
  - ii) L-1 is "Non-MSE but Class-I local supplier": Purchase preference shall be given to MSEs, if eligible, as per PPP-MSE Order. Balance quantity be awarded to L-1 bidder.
  - iii) L-1 is "MSE but non-Class-I local supplier": Purchase preference shall be given to Class-I local suppliers, if eligible, as per PPP-MII Order. Balance quantity be awarded to L-1 bidder.
  - iv) L-1 is "Non-MSE non-Class-I local supplier": Firstly, Purchase preference shall be given to MSEs as per PPPMSE Order. Thereafter, purchase preference is to be given to Class-I local suppliers for "50% of the tendered quantity minus quantity allotted to MSEs above" as per PPP- MII Order. For the balance quantity, contract be awarded to L-1 bidder. (Kindly refer to the illustrative example in the MoF, DoE OM at Enclosure-II).
- f) In the procurement of goods, services which are covered in para 23 (K) (ii) above and which are not divisible in nature, and in procurement of services where the bid is evaluated on price alone (Items covered under Para 3A(c) of PPP-MII Order, 2017) and both MSEs as well as Class-I local suppliers are eligible for purchase preference Purchase preference shall be accorded as under:
- i) L-1 is "MSE Class-I local supplier": Contract shall be awarded to L-1.
  - ii) L-1 is not "MSE Class-I local supplier " but the "MSE Class-I local supplier" falls within 15% margin of purchase preference. Purchase preference shall be given to lowest quoting "MSE Class-I local supplier". If lowest quoting "MSE Class-I local supplier" does not accept the L-1 rates, the next higher "MSE Class-I local supplier" falling within 15% margin of purchase preference is to be given purchase preference and so on. If all "MSE Class-I local supplier" do not accept L-1 rates, then (f)(iii) shall be followed.
  - iii) If conditions mentioned in sub paras (f)(i) and (f)(ii) above are not met i.e. L1 is not "MSE Class-I local supplier" and "MSE Class-I local supplier" is not eligible to take benefit of purchase preference as per PPP-MSE Order or all "MSE Class-I local supplier" do not accept L-1 rates, the contract is to be awarded / purchase preference to be given in different possible scenarios as under:
    - a) L-1 is "MSE but non-Class-I local supplier" or "Non- MSE but Class-I local supplier": Contract be awarded to L-1.
    - b) L-1 is "Non-MSE non-Class-I local supplier": Firstly, purchase preference shall be given to eligible MSE as per PPP-MSE Order. If MSEs not eligible or does not accept then purchase preference to be given to eligible Class- I Local supplier as per PPPMII Order. If Class-I Local supplier is also not eligible or does not accept then contract be awarded to L-1.
- g) Items reserved for both MSEs and Class-I local suppliers: These items are reserved exclusively for purchase from MSEs as well as Class-I local suppliers. Hence, only "MSE Class-I local supplier" are eligible to bid for these items. Non-MSEs / Class-II local suppliers / Non-local suppliers cannot bid for these items. Hence the question of purchase preference does not arise.

- h) Non-local suppliers, including MSEs falling in the category of Non-local suppliers, shall be eligible to bid only against Global Tender Enquiry.

**27. Minimum Local Content:**

- i) The 'local content' requirement to categorize a supplier as 'Class-I local supplier' is minimum 50%. For 'Class-II local supplier', the 'local content' requirement is minimum 20%. However, Nodal Ministry / Department may prescribe only a higher percentage of minimum local content requirement to categorize a supplier as 'Class-I local supplier' / 'Class-II local supplier'. For the items, for which Nodal Ministry / Department has not prescribed higher minimum local content notification under the Order, it shall be 50% and 20% for 'Class-I local supplier' and 'Class-II local supplier' respectively.
- ii) The Nodal Ministry may keep in view the domestic manufacturing / supply base and assess the available capacity and the extent of local competition while identifying items and prescribing the higher minimum local content or the manner of its calculation, with a view to avoiding cost increase from the operation of this Order.

**28. Reciprocity Clause:**

- i) Entities of countries which have been identified by the nodal Ministry / Department as not allowing Indian companies to participate in their Government procurement for any item related to that nodal Ministry shall not be allowed to participate in Government procurement in India for all items related to that nodal Ministry / Department, except for the list of items published by the Ministry / Department permitting their participation.
- ii) The term 'entity' of a country shall have the same meaning as under the FDI Policy of DPIIT as amended from time to time.

**29. Debarment of bidders / suppliers:**

- i) False declaration will be in breach of Code of Integrity under Rule 175(1)(i)(h) of GFR 2017 for which a bidder or its successors can be debarred for up to 2 years as per Rule 151(iii) of GFR 2017 along with such other actions as may be permissible under law.
- ii) A supplier who has been debarred by any procuring entity for violation of said Order shall not be eligible for preference under said Order for procurement by any other procuring entity for the duration of debarment. The debarment for such other procuring entities shall take effect prospectively from the date on which it comes to the notice of other procurement entities, in such a manner that ongoing procurements are not disrupted.

**30. Export License:**

The Export licence that may be required for delivery of various items / equipment to MDL shall be arranged by the respective Bidders / Suppliers / Contractors from the concerned authorities in their respective countries. The Bidders / Suppliers / Contractors shall take in to account the period required for obtaining such license while indicating delivery / completion periods for the items / equipment and delays in supplies for non-availability of such licenses are to be accounted for by the Supplier / Contractor. The 'End User' certificate if required by the supplier for obtaining the license is to be forwarded by MDL. However, the format and details of the end user certificate required should be forwarded by the supplier to MDL along with the order acceptance. The dealing commercial executive shall arrange the end user certificate and dispatch the same to the supplier most expeditiously.

**31. Provisions of Official Secrets Act, 1923:**

Extract of provisions of the Official Secret Act as per the enclosure should be signed stamped and enclosed in the offer.

**32. Public Grievance Cell:**

A Public Grievance Cell headed by Shree R R Kumar (ED-Production), President, has been set up in the Company. Members of public having complaints or grievances are advised to contact him on Wednesday between 10.00 hours and 12.30 hours in his office on 3rd floor, west Block, MAZAGON

DOCK SHIPBUILDERS LTD, Dock Yard Road, Mumbai 400010, INDIA or send their complaints / grievances to him in writing for redressal. His Telephone No. is 022 2378 2338, 2376 2106.

### **33. Book Examination Clause (BEC):**

~~In case it is found to the satisfaction of MDL that the Supplier has engaged an Agent or paid commission or influenced any person to obtain the contract as described in clauses relating to Agents/Agency Commission and penalty for use of undue influence, the supplier, on a specific request of MDL shall provide necessary information/inspection of the relevant financial documents/information.~~

### **34. Liquidated Damages:**

If the Seller/Service Provider fails to deliver any or all of the Goods/Services within the original/re-fixed delivery period(s) specified in the contract, the Buyer will be entitled to deduct/recover the Liquidated Damages for the delay, unless covered under Force Majeure conditions aforesaid, @ 2% of the contract value of delayed quantity per week or part of the week of delayed period as pre-estimated damages not exceeding 10% of the contract value of delayed quantity without any controversy/dispute of any sort whatsoever.

### **35. Integrity Pact:**

- ~~i) The bidder has to submit Integrity Pact as per the attached format in the enclosure.~~
- ~~ii) Each page of Integrity pact shall be duly signed by the bidder. Non submission of Integrity pact by the bidders duly signed on each page along with Part I bid shall be liable for rejection.~~
- ~~iii) In case of issues related to Integrity Pact (IP) please contact Independent External Monitor (IEM) whose details are as below:-~~

#### **a) Mr. P V Rao**

~~—Email id: [pasupuletirao@yahoo.co.in](mailto:pasupuletirao@yahoo.co.in)~~

### **36. Option Clause:**

MDL retains the right to increase/decrease the ordered quantity by up to 50 % at any time, till final delivery date (or the extended delivery date of the contract), by giving reasonable notice even though the quantity ordered initially has been supplied in full before the last date of the delivery period (or the extended delivery period).

### **37. Common / Deemed DPSU registration and Green Channel Status clause:**

- i) Suppliers / Contractors registered in other Defence PSUs for the tendered item / service shall be considered by MDL as Deemed Registered.
- ii) Green Channel Policy is formulated by DDP, MoD and promulgated vide O.M. No. 43(5)/2015/D(QA) dated 24.03.2017. Suppliers holding Green Channel Certificate for the tendered item shall be considered by MDL as Deemed Registered.

### **38. Land Border Clause:**

(Restrictions under Rule 144 (xi) of the General Financial Rules (GFRs), 2017)

- i) MoF DoE vide OMs No 6/18/2019-PPD dated 23 Jul 2020 & 24 Jul 2020 and OM No F.7/10/2021/-PPD (1) dated 23.02.2023 has promulgated restrictions and procedure for buying from a bidder from a country which shares a land border with India under GFR Rule 144 (xi) on the grounds of Defence of India and National Security for information and compliance.
- ii) The Orders stipulate mandatory registration with competent authority and seeking certificate of compliance with this Order from the bidder from a country which shares a land border with India in the tender process. Exclusions from these restrictions have also been enlisted in the Order. The Competent authority for the purpose of registration under this Order shall be the Registration Committee constituted by the Department for Promotion of Industry and Internal Trade (DPIIT).
- iii) A bidder is permitted to procure raw material, components etc. from the vendors from countries which shares a land border with India. Such vendors will not be required to be registered with

Competent Authority, as it is not regarded as "sub-contracting". However, if bidder has proposed to supply finished goods procured directly/ indirectly from the vendors from the countries sharing land border with India, such vendor will be required to be registered with the Competent Authority.

- iv) The bidder has to enclose filled signed and stamped certificate for "Declaration of Compliance on Restrictions under Rule 144 (xi) of the General Financial Rules (GFRs), 2017" as per the enclosure.

**39. Consignee details:**

Firm shall arrange dispatch of good by appropriate transport mode as per the order and consign the same to Onsite at Mundra Port.

**40. Inspection and Testing:**

- i) Pre-despatch Third Party Inspection by any TPI who is the member of International Association for Classification Society (IACS). Vendor will arrange the inspection with intimation to MDL.
- ii) Charges for TPI shall be borne by the bidder.
- iii) Inspection of the materials will be carried out as mentioned in the Scope of Work.
- iv) Documentation: COC from supplier and Material inspection certificate (Chemical and Physical) from NABL laboratory or 3.1 Mill test certificate / dimensional reports/ warranty certificate, etc.
- v) Receipt Inspection- MDL User
- vi) Warranty certificate as per the enclosure.

**~~41. Work Done Certificate (WDC) (for Works):~~**

~~Work Completion certificate (WCC) shall be issued on Satisfactory completion of respective work with inspection and acceptance reports. Additional Project team executive of rank Chief manager and above will issue WCC.~~

**42. Breach of Obligation Clause with respect to Bid Submitted:**

In case of breach of any obligation mentioned under, the bidder shall be disqualified / debarred from the bidding process for a period of one year from the date of notification,

- i) Bidder has withdrawn / modified / amended / impaired / derogated from the tender during the period of bid validity.
- ii) Bidder fails or refuses to execute the contract upon notification of acceptance of bid by MDL during the period of bid validity.

**43. Right to reject any or all bids:**

MDL reserves its right to accept or reject any or all bids, abandon / cancel the tender process, and issue another tender for the same or similar Goods/Services at any time before the award of the contract. It would have no liability to the affected Bidder or Bidders or any obligation to inform the affected Bidder or Bidders of the grounds for such action(s).

**44. Contacting MDL during the evaluation:**

From the time of bid submission to awarding the contract, no bidder shall contact MDL on any matter relating to the submitted bid. If a Bidder needs to contact MDL for any reason relating to this tender and/ or its bid, it should do so only in writing or electronically. Any effort by a Bidder to influence MDL during the processing of bids, evaluation, bid comparison or award decisions shall be construed as a violation of the Code of Integrity, and bid shall be liable to be rejected as nonresponsive in addition to other punitive actions for violation of Code of Integrity as per the Tender Document.

**45. Claims by firms:**

No claims by the firms will be entertained after 03 years from date of execution/completion of order.

**46. Cancellation / Foreclosure / Termination of order:**

Action for cancellation / foreclosure / termination of order shall be taken in any of the following conditions / circumstances.

- i) On the basis of Government Order.



- ii) Defaults / Breach on part of the contractor / Supplier / supplier in complying with agreed terms of order / contract.
- iii) Liquidation / Dissolution of the Firm or entity on whom the original order is placed.
- iv) Unreasonable delays in supply of ordered articles or services or documentation.
- v) Supplies made not meeting the ordered specifications.
- vi) Activities of any of the Proprietor / Partner being found to be Antisocial / Anti -National liable for penal action under Indian Penal Code or imposed with penalty of black listing / debarred by MDL, Owners, Govt. of India or any such authorities at any time during validity of the contract / order.
- vii) The Purchase Order not accepted by the vendor within the stipulated period.

When the contractor / Supplier is found to be liable for action under any of the above provisions, MDL may terminate or cancel the contract / order in part or full by written notice of default sent to the contractor / Supplier without prejudice to any other remedy invoking risk purchase clause and execution of work / order through other agencies.

#### **47. Cartel Formation/Pool Rates:**

- i) Pool/cartel formation is against the basic principle of competitive bidding and defeats the very purpose of an open and competitive tendering system. Such and similar tactics to avoid/control true competition in a tender leading to "Appreciable Adverse Effect on Competition" (AAEC) have been declared as an offence under the Competition Act, 2002, as amended by the Competition (Amendment) Act, 2007.
- ii) If this is found, suitable administrative actions can be resorted to, such as rejecting the offers, reporting the matter to trade associations, the Competition Commission or NSIC, etc., and requesting them, inter-alia, to take suitable strong actions against such firms. The purchaser may also debar the tenderers indulging in cartel formation/collusive bidding/bid rigging for a period of two years from participation in the tenders of the Purchaser.

#### **48. Conflict of Interest Among Bidders/ Agents:**

A bidder shall not have conflict of interest with other bidders. Such conflict of interest can lead to anti-competitive practices to the detriment of MDL's interests. The bidder found to have a conflict of interest shall be disqualified. A bidder may be considered to have a conflict of interest with one or more parties in this bidding process, if:

- (i) they have controlling partner (s) in common; or
- (ii) they receive or have received any direct or indirect subsidy/ financial stake from any of them; or
- (iii) they have the same legal representative/agent for purposes of this bid; or
- (iv) they have relationship with each other, directly or through common third parties, that puts them in a position to have access to information about or influence on the bid of another Bidder; or
- (v) Bidder participates in more than one bid in this bidding process. Participation by a Bidder in more than one Bid will result in the disqualification of all bids in which the parties are involved. However, this does not limit the inclusion of the components/ sub-assembly/ Assemblies from one bidding manufacturer in more than one bid.
- (vi) In cases of agents quoting in offshore procurements, on behalf of their principal manufacturers, one agent cannot represent two manufacturers or quote on their behalf in a particular tender enquiry. One manufacturer can also authorise only one agent/dealer. There can be only one bid from the following:
  - (a) The principal manufacturer directly or through one Indian agent on his behalf; and
  - (b) Indian/foreign agent on behalf of only one principal.

(vii) Bidder or any of its affiliates participated as a consultant in the preparation of the design or technical specifications of the contract that is the subject of the Bid;

(viii) In case of a holding company having more than one independently manufacturing units, or more than one unit having common business ownership/management, only one unit should quote. Similar restrictions would apply to closely related sister companies. Bidders must proactively declare such sister/ common business/ management units in same/similar line of business.

**Note: The undertaking by the bidders for above para (Conflict of Interest among Bidders/ Agents) to be submitted along with the bid.**

**49. Order Acceptance:**

Successful bidder shall acknowledge the receipt and communicate in writing their unconditional acceptance of order within 03 working days from the date of placement of the order. If nothing to the contrary is received within 03 working days from the date of placement of order, it shall be understood that the order has been accepted.

**Any other terms and conditions not mentioned above but mentioned in Scope of work at the enclosure will be applicable.**

**We look forward to receive your most competitive and reasonable offer against this tender.**

**For MAZAGON DOCK SHIPBUILDERS LIMITED**

**Ranjeet Kumar, DM (C-EY) (Purchase Executive)  
Email: ranjeetkumar100261@mazdock.com  
Phone: 022 2376 2615**

**List of enclosures:**

1. Enclosure 1: TEF acceptance Format.
2. Enclosure 2: Rate sheet
3. Enclosure 3: General Conditions of Contract (GCCs)
4. Enclosure 4: Acceptance format for General Conditions of Contract (GCCs)
5. Enclosure 5: Declaration of Compliance on Restrictions under Rule 144 (xi) of the General Financial Rules (GFRs), 2017
6. Enclosure 6: Declaration certificate for local content
7. Enclosure 7: Extract of provisions of the official secrets act, 1923
8. Enclosure 8: Performa Performance Bank Guarantee cum Security Deposit
9. ~~Enclosure 9: Format for Integrity Pact~~
10. Enclosure 10: Format for warranty certificate
11. Enclosure 11: Deed of guarantee
12. Enclosure 12: Undertaking for Conflict of Interest among Bidders/ Agents
13. Enclosure 13: NEFT/RTGS format
14. Enclosure 14: Functional specifications

**Note: Bidders have to upload filled and signed enclosures along with the offers on their letterhead except for the bonds and the bank guarantees.**

**TEF ACCEPTANCE FORMAT**

| <b>TEF<br/>CLAUSE<br/>No.</b> | <b>BIDDER'S<br/>REMARK</b> | <b>TEF<br/>CLAUSE No.</b> | <b>BIDDER'S<br/>REMARK</b> | <b>TEF<br/>CLAUSE No.</b> | <b>BIDDER'S<br/>REMARK</b> |
|-------------------------------|----------------------------|---------------------------|----------------------------|---------------------------|----------------------------|
| 1.                            | ACC / DEV                  | 2.                        | ACC / DEV                  | 3.                        | ACC / DEV                  |
| 4.                            | ACC / DEV                  | 5.                        | ACC / DEV                  | 6.                        | ACC / DEV                  |
| 7.                            | ACC / DEV                  | 8.                        | ACC / DEV                  | 9.                        | ACC / DEV                  |
| 10.                           | ACC / DEV                  | 11.                       | ACC / DEV                  | 12.                       | ACC / DEV                  |
| 13.                           | ACC / DEV                  | 14.                       | ACC / DEV                  | 15.                       | ACC / DEV                  |
| 16.                           | ACC / DEV                  | 17.                       | ACC / DEV                  | 18.                       | ACC / DEV                  |
| 19.                           | ACC / DEV                  | 20.                       | ACC / DEV                  | 21.                       | ACC / DEV                  |
| 22.                           | ACC / DEV                  | 23.                       | ACC / DEV                  | 24.                       | ACC / DEV                  |
| 25.                           | ACC / DEV                  | 26.                       | ACC / DEV                  | 27.                       | ACC / DEV                  |
| 28.                           | ACC / DEV                  | 29.                       | ACC / DEV                  | 30.                       | ACC / DEV                  |
| 31.                           | ACC / DEV                  | 32.                       | ACC / DEV                  | 33.                       | ACC / DEV                  |
| 34.                           | ACC / DEV                  | 35.                       | ACC / DEV                  | 36.                       | ACC / DEV                  |
| 37.                           | ACC / DEV                  | 38.                       | ACC / DEV                  | 39.                       | ACC / DEV                  |
| 40.                           | ACC / DEV                  | 41.                       | ACC / DEV                  | 42.                       | ACC / DEV                  |
| 43.                           | ACC / DEV                  | 44.                       | ACC / DEV                  | 45.                       | ACC / DEV                  |
| 46.                           | ACC / DEV                  | 47.                       | ACC / DEV                  | 48.                       | ACC / DEV                  |
| 49.                           | ACC / DEV                  |                           |                            |                           |                            |

COMPANY'S NAME &amp; ADDRESS:

---



---



---

SIGNATURE:

DATE:

NAME:

DESIGNATION:

BIDDER'S COMPANY SEAL:

**Note:**

- Bidder confirms to have carefully read the Terms & Conditions enclosed only with this Tender Enquiry Form (TEF) prior to filling up this acceptance format.
- Bidder confirms that this format has been **properly filled, signed and returned** along with our technical offer (Part-I) for considering the Bid.
- Bidder confirms to have indicated **"ACC" for Accepted, "DEV" for Deviation** taken for each clause number in the above table.
- In case of any deviations taken the bidder confirms to have attached **Separate Sheet** indicating all relevant details such as Number & Title / brief description of the Clause, **Reasons for Deviation and suggested alternative(s)**.
- Clause numbers shown in the above format also includes the sub-clauses under these clauses. For example, Clause no. 8 means - Clause nos. 8-a (i) to (iv), b (i) to (xiii)& c

**RATE SHEET PRESCRIBED FORMAT***(Please quote on your letter head only)***Note: Do not mention prices in part 1 Bid (Technical Bid). Mention quoted/Not quoted in technical bid against each line items.**

| Sr.No | Material/Service description   | Qty  | Unit | Unit rate | Total Value |
|-------|--|------|------|-----------|-------------|
| 10    | Material Number: -350000000000080685<br>Material group: -<br>1000000 - MISC ITEMS (On charge off basis)<br>Material Details: -<br>Flange Size (inch): 16"<br>Rating: #1500<br>Material: Stud: - ASTM A 320 Grade L43<br>Nut: - ASTM A 194 Gr. 7<br>Size of stud: Diameter 2.5-inch x Length<br>470 mm<br>Coating : Xylan Coated  | 400  | SET  |           |             |
| 20    | Material Number: -350000000000080686<br>Material group: -<br>1000000 - MISC ITEMS (On charge off basis)<br>Material Details: -<br>Flange Size (inch): 16"<br>Rating: #900<br>Material: Stud: - ASTM A 193 Gr. B7M<br>Nut: - ASTM A 194 Gr. 2HM<br>Size of Stud: Diameter 1.625-inch x Length 290<br>mm<br>Coating : Xylan Coated | 1500 | SET  |           |             |
| 30    | Material Number: -350000000000080687<br>Material group: -<br>1000000 - MISC ITEMS (On charge off basis)<br>Material Details: -<br>Flange Size (inch): 14"<br>Rating: #1500<br>Material: Stud: - ASTM A 193 Gr. B7M<br>Nut: - ASTM A 194 Gr. 2HM<br>Size of stud: Diameter 2.25-inch x Length 425 mm<br>Coating : Xylan Coated    | 400  | SET  |           |             |
| 40    | Material Number: -350000000000080689<br>Material group: -<br>1000000 - MISC ITEMS (On charge off basis)<br>Material Details: -<br>Flange Size (inch): 14"<br>Rating: #1500<br>Material: Stud: - ASTM A 193 Gr. B7M<br>Nut: - ASTM A 194 Gr. 2HM<br>Size of stud: Diameter 2.375-inch x Length 425 mm<br>Coating : Xylan Coated   | 400  | SET  |           |             |
| 50    | Material Number: -350000000000080690<br>Material group: -<br>1000000 - MISC ITEMS (On charge off basis)<br>Material Details: -<br>Flange Size (inch): 12.75"<br>Rating: #1500  | 1200 | SET  |           |             |

|     |  |      |     |  |  |
|-----|--|------|-----|--|--|
|     | Material: Stud: - ASTM A 193 Gr. B7M<br>Nut: - ASTM A 194 Gr. 2HM<br>Size of stud Diameter 2-inch x Length 385 mm<br>Coating : Xylan Coated  |      |     |  |  |
| 60  | Material Number: -350000000000080691<br>Material group: -<br>1000000 - MISC ITEMS (On charge off basis)<br>Material Details: -<br>Flange Size (inch): 12.75"<br>Rating: #1500<br>Material: Stud: - ASTM A 193 Gr. B7M<br>Nut: - ASTM A 194 Gr. 2HM<br>Diameter 1.375-inch x Length 385 mm<br>Coating : Xylan Coated              | 1000 | SET |  |  |
| 70  | Material Number: -350000000000080692<br>Material group: -<br>1000000 - MISC ITEMS (On charge off basis)<br>Material Details: -<br>Flange Size (inch): 12.75"<br>Rating: #900<br>Material: Stud: - ASTM A 193 Gr. B7M<br>Nut: - ASTM A 194 Gr. 2HM<br>Size of stud: Diameter 1.375-inch x Length 255 mm<br>Coating : Xylan Coated | 2000 | SET |  |  |
| 80  | Material Number: -350000000000080693<br>Material group: -<br>1000000 - MISC ITEMS (On charge off basis)<br>Material Details: -<br>Flange Size (inch): 10.75"<br>Rating: #900<br>Material: Stud: - ASTM A 193 Gr. B7<br>Nut: - ASTM A 194 Gr. 2H<br>Size of stud: Diameter 1.375-inch x Length 235 mm<br>Coating : Xylan Coated   | 800  | SET |  |  |
| 90  | Material Number: -350000000000080694<br>Material group: -<br>1000000 - MISC ITEMS (On charge off basis)<br>Material Details: -<br>Flange Size (inch): 8.625"<br>Rating: #1500<br>Material: Stud: - ASTM A 193 Gr. B7M<br>Nut: - ASTM A 194 Gr. 2HM<br>Size of stud Diameter 1.625-inch x Length 325 mm<br>Coating : Xylan Coated | 300  | SET |  |  |
| 100 | Material Number: -350000000000080695<br>Material group: -<br>1000000 - MISC ITEMS (On charge off basis)<br>Material Details: -<br>Flange Size (inch): 6.625"<br>Rating: #1500<br>Material: Stud: - ASTM A 193 Gr. B7M<br>Nut: - ASTM A 194 Gr. 2HM<br>Size of stud: Diameter 1.375inch x Length 265 mm<br>Coating : Xylan Coated | 300  | SET |  |  |
|     | Total Value  |      |     |  |  |

|   |  |
|---|--|
| <b>a. The seller has read, understood and accept the complete Scope of work. (Yes/No)</b> |  |
|---|--|

| <b>Taxes and duties</b>                       |                        |  |
|---|------------------------|--|
| <b>Tax head</b>                               | <b>Rate applicable</b> | <b>Percentage of total Amount on which the tax is applicable</b> |
| GST   |                        |  |
| Any other Taxes/Duties<br>(Bidder to specify) |                        |  |

**Note:**

- i) The Prices indicated in the Price Bid shall be as per rate sheet only. (Please check carefully for taxes before bidding).**
- ii) The bidder shall provide the quoted price breakup of all the items after price bid opening.**
- iii) There should be provision for 10% increase / decrease in quantity and the quoted unit prices to remain fixed(unchanged) for the same.**  
 Provisions for 10% increase/decrease in quantity" is as under:
  - 10% increase in quantity will be absorbed in the same PO price. No additional amount will be paid to vendor.
  - In case of 10% decrease in quantity, amount equivalent to 10% short/less material will be deducted from the vendor amount.

Name: .....

Designation: .....

Date: .....

Bidders Company Seal .....

-----

**Enclosure-3****GENERAL CONDITIONS OF CONTRACT (GCC)**

The word 'Purchaser' refers to MAZAGON DOCK SHIPBUILDERS LIMITED, (MDL), a Company within the meaning of Companies Act, 2013 and it includes its successors or assignees.

The word 'Bidder' (including the term 'tenderer', 'consultant' 'vendor' or 'service provider' in certain contexts) means any legal entity such as firm(s) of Proprietorship / Partnership Firm / Limited Liability Partnership / Private Limited / Limited company / Society registered under Society's Act / Statutory Bodies/ Consortium/ Joint Venture etc. participating in a procurement process.

The word 'Owner' means the person or authority with whom Mazagon Dock Shipbuilders Limited (Purchaser) has contracted to carry out work in relation to which orders are placed by the Purchaser on the Bidder/Supplier/Contractor under this contract for supply or manufacture of certain items and would include Department of Defence Production, Ministry of Defence, Government of India, the Indian Navy, the Coast Guard and any other specified authority. Unless otherwise indicated specifically by the bidder / contractor in his bid, it shall be construed as his acceptance of all the conditions mentioned in this GCC.

**1. TENETS OF INTERPRETATION**

Unless where the context requires otherwise, throughout the contract:

- (a) The heading of these conditions shall not affect the interpretation or construction thereof.
- (b) Writing or written includes matter either whole or in part, in digital communications, manuscript, typewritten, lithographed, cyclostyled, photographed, or printed under or over signature or seal or digitally acceptable authentication, as the case may be.
- (c) Words in the singular include the plural and vice-versa.
- (d) Words importing the masculine gender shall be taken to include other genders, and words importing persons shall include any company or association or body of individuals, whether incorporated or not.
- (e) Terms and expression not herein defined shall have the meanings assigned to them in the Contract Act, 1872 (as amended) or the Sale of Goods Act, 1930 (as amended) or the General Clauses Act, 1897 (as amended) or of INCOTERMS, (current edition published by the International Chamber of Commerce, Paris) as the case may be.
- (f) Any reference to 'Goods' shall be deemed to include the incidental Works/ Services also.
- (g) Any generic reference to GCC shall also imply a reference to TEF as well.
- (h) In case of conflict, provisions of TEF shall prevail over those in GCC.



- (i) Any reference to 'Contract' shall be deemed to include all other documents (inter-alia GCC, TEF).
- (j) Any reference to any legal Act, Government Policies or orders shall be deemed to include all amendments to such instruments, from time to time, till date.
- (k) Fall Clause shall be expressly applicable in the case of Rate Contract.

## **2. LANGUAGE OF CONTRACT**

Unless otherwise stipulated in TEF, the contract shall be written in the Official Language or English. All correspondence and other contract documents, which the parties exchange, shall also be written/ translated accordingly in that language. For purposes of interpretation of the contract, the English documents/ translation shall prevail.

## **3. GOVERNING LAWS AND JURISDICTION**

### **3.1 Governing Laws and Jurisdiction**

(a) This Contract, its meaning and interpretation, and the relation between the Parties shall be governed by the Laws of India for the time being in force.

(b) Irrespective of the place of delivery, or the place of performance or the place of payments under the contract, the contract shall be deemed to have been made at the place from which the Purchase Order/Contract/Letter of Intent has been issued. The courts of such a place shall alone have jurisdiction to decide any dispute arising out or in respect of the contract.

### **3.2 Changes in Laws and Regulations**

Unless otherwise stipulated in the contract, if after the last deadline for the bid submission (Techno-commercial), any law, regulation, ordinance, order or bye-law having the force of law is enacted, promulgated, abrogated, or changed in India (which shall be deemed to include any change in interpretation or application by the competent authorities) that subsequently affects the Delivery Date and/ or the contract Price, then such Delivery Date and/ or Contract Price shall be correspondingly increased or decreased, to the extent that the contractor has thereby been affected in the performance of any of its obligations under the contract. Notwithstanding the foregoing, such additional or reduced cost shall not be separately paid or credited if the same has already been accounted for in the price adjustment provisions where applicable.

## **4. CONFIDENTIALITY, SECRECY AND IPR RIGHTS**

### **(a) IPR Rights**

All deliverables, outputs, plans, drawings, specifications, designs, reports, and other documents and software submitted by the contractor under this Contract shall become and remain the property of MDL and subject to laws of copyright and must not be shared with third parties or reproduced, whether in whole or part, without MDL's prior written consent. The contractor shall, not later than upon termination or expiration of this Contract, deliver all such documents and software to MDL, together with a detailed inventory thereof. The contractor may retain a copy of such documents and software but shall not use it for any commercial purpose.

### **(b) Confidentiality**

All documents, drawings, samples, data, associated correspondence or other information furnished by or on behalf of MDL to the contractor, in connection with the contract, whether such information has been furnished before, during or following completion or termination of the contract, are confidential and shall remain the property of MDL and shall not, without the prior written consent of MDL neither be divulged by the contractor to any third party, nor be used by him for any purpose other than the design, procurement, or other services and work required for the performance of this Contract. If advised by MDL, all copies of all such information in original shall be returned on completion of the contractor's performance and obligations under this contract.

### **(c) Secrecy**

If the Contract declares the subject matter of this Contract as coming under the Official Secrets Act, 1923 or if the contract is marked as "Secret", the contractor shall take all reasonable steps necessary to ensure that all persons employed in any connection with the contract, have acknowledged their responsibilities and penalties for violations under the Official Secrets Act and any regulations framed thereunder.

### **(d) Obligations of the contractor**

(i) Without MDL's prior written consent, the contractor shall not use the information mentioned above except for the sole purpose of performing this contract.

(ii) The contractor shall treat and mark all information as confidential (or Secret – as the case may) and shall not, without the written consent of MDL, divulge to any person other than the person(s) employed by the contractor in the performance of the contract. Further, any such disclosure to any such employed person shall be made in confidence and only so far as necessary for such performance for this contract.

(iii) Notwithstanding the above, the contractor may furnish to its holding company or its Subcontractor(s) such documents, data, and other information it receives from MDL to the extent required for performing the contract. In this event, the contractor shall obtain from such holding company/ Subcontractor(s) an undertaking of confidentiality (or secrecy – as the case may be) similar to that imposed on the contractor under the above clauses.

(iv) The obligation of the contractor under sub-clauses above, however, shall not apply to information that:

(aa) The contractor needs to share with the institution(s) participating in the financing of the contract;

(ab) now or hereafter is or enters the public domain through no fault of Contractor;

(ac) can be proven to have been possessed by the contractor at the time of disclosure and which was not previously obtained, directly or indirectly, from MDL; or

(ad) otherwise lawfully becomes available to the contractor from a third party that has no obligation of confidentiality.

(v) The above provisions shall not in any way modify any undertaking of confidentiality (or Secrecy – as the case may be) given by the contractor before the date of the contract in respect of the contract/ the Tender Document or any part thereof.

(vi) The provisions of this clause shall survive completion or termination for whatever reason of the contract.

## **5. PERMITS, APPROVALS AND LICENSES**

Whenever the supply of Goods and incidental Services requires that the contractor obtain permits, approvals, and licenses from local public authorities, it shall be the contractor's sole responsibility to obtain these and keep these current and valid. Such requirements may include but not be restricted to export licence or environmental clearance if required. If requested by the contractor, MDL shall make its best effort to assist the contractor in complying with such requirements in a timely and expeditious manner, without any dilution of the Contractor's responsibility in this regard.

## **6. TRANSFER OF TITLE OF GOODS**

(a) Unless otherwise stated in the contract, notwithstanding any inspection and approval by the Inspecting Officer on the contractor's premises, or any payments made to the contractor, property in the Goods (and resultant rights and liabilities) shall not pass on to MDL until the Goods have been received, inspected, and accepted by the consignee. The Goods and every constituent part thereof, whether in the possession or control of the contractor, his agents or servants or a carrier, or the joint possession of the contractor, his agents or servants and MDL, his agents, or servants, shall remain in every respect at the risk of the contractor, until their actual delivery to a person stipulated in the contract, as the interim consignee for despatch to the consignee. The Contractor shall be responsible for all loss, destruction, damage, or deterioration of or to the Goods from any cause whatsoever while the Goods after approval by the Inspecting Officer are awaiting despatch or delivery or are in the course of transit from the contractor to the consignee or interim consignee, as the case may be. The Contractor shall alone be entitled and responsible for making claims against any carrier in respect of non-delivery, short delivery, mis-delivery, loss, destruction, damage, or deterioration of the Goods entrusted to such carrier by the contractor for transmission to the consignee or the interim consignee as the case may be.

(b) Provided that where, under the terms of the contract, the Goods are required to be delivered to an interim consignee for despatch to the consignee, the Goods shall be at MDL's risk after their delivery to the interim consignee.

## **7. EXTENSION OF DELIVERY PERIOD**

(a) If at any time during the currency of the contract, the contractor encounters conditions hindering timely delivery of the Goods and performance of incidental Works/ Services, he shall promptly inform MDL in writing about the same and its likely duration. He must make a request to MDL for an extension of the delivery schedule. On receiving the contractor's communication, MDL shall examine the situation and, at its discretion, may agree to extend the delivery schedule, with or without liquidated damages and with and without denial clause by issuing an amendment to the contract.

**(b) Conditions for Extension of Delivery Period**

When the period of delivery is extended due to unexcused delay (Note: please ensure that unexcused delay is defined. Otherwise replace "unexcused delay" with the "delays attributable") by the contractor, the amendment extending the delivery period shall, inter alia, be subject to the following conditions:

**(i) Liquidated Damages**

MDL shall recover from the contractor, under the provisions of this clause, liquidated damages on the Goods and incidental Works/ Services, which the contractor has failed to deliver within the delivery period stipulated in the contract.

**(ii) Denial Clause**

(aa) No increases in price on account of any statutory increase in or fresh Imposition of GST, customs duty or on account of any other taxes/ duty/ cess/ levy), leviable in respect of the Goods and incidental Works/ Services stipulated in the said contract which takes place after the original delivery date, shall be admissible on such of the said Goods, as are delivered after the said date; and

(ab) Notwithstanding any stipulation in the contract for an increase in price on any other ground, including price variation clause or foreign exchange rate variation, or any other variation clause, no such increase after the original delivery date shall be admissible on such goods delivered after the said date.

(ac) Nevertheless, MDL shall be entitled to the benefit of any decrease in price on account of reduction in or remission of GST, customs duty or on account of any other Tax or duty or any other ground as stipulated in the price variation clause or foreign exchange rate variation or any other variation clause which takes place after the expiry of the original delivery date.

**(c) Liquidated damages**

If the contractor fails to deliver any or all of the Goods or fails to perform the incidental Works/ Services (e.g. installation, commissioning or operator training) within the time frame(s) incorporated in the contract, MDL shall, without prejudice to other rights and remedies available to MDL under the contract, deduct from the contract price, as agreed liquidated damages, but not as a penalty, a sum equivalent to the 2 % percent (excluding taxes) of the delivered price of the delayed Goods and/ or incidental Works/ Services for each week of delay or part thereof until actual delivery or performance, subject to a maximum deduction of the 10% of the delayed Goods' or incidental Works/ Services' contract price(s). Besides liquidated damages during such a delay, the denial clause shall also apply. Any failure or delay by any subcontractor, though their employment may have been sanctioned shall not be admitted as a ground for any extension of time or for exempting the contractor from liability for any such loss or damage as aforesaid.

**8. DEFAULTS, BREACHES & TERMINATION OF CONTRACT**

Termination due to Breach, Default, and Insolvency

**(a) Defaults and Breach of Contract**

In case the contractor undergoes insolvency or receivership; neglects or defaults, or expresses inability or disinclination to honour his obligations relating to the performance of the contract or ethical standards or any other obligation that substantively affects MDL's rights and benefits under the contract, it shall be treated as a breach of Contract. Such defaults shall include inter-alia:

**(i) Default in Performance and Obligations**

If the contractor fails to deliver any or all of the Goods or fails to perform any other contractual obligations (including Code of Integrity or obligation to maintain eligibility and Qualifications based on which contract was awarded) within the period stipulated in the contract or within any extension thereof granted by MDL.

**(ii) Insolvency**

If the contractor is wound up or ceases to otherwise trade or is unable to pay its debts as and when they fall due or is otherwise subject to any insolvency procedure.

(iii) If a receiver or similar official is appointed overall or any of the assets of the contractor or a petition is presented for its winding up or it entered into a composition with its creditors;

**(b) Notice for Default**

As soon as a breach of contract is noticed, a show-cause 'Notice of Default' shall be issued to the contractor, giving two weeks' notice, reserving the right to invoke contractual remedies. After such a show-cause notice, all payments to the contractor would be temporarily withheld to safeguard needed recoveries that may become due on invoking contractual remedies.

**(c) Terminations for Default**

(i) Notice for Termination for Default: In the event of unsatisfactory resolution of 'Notice of Default' within two weeks of its issue as per sub-clause above, MDL if so decided, shall by written Notice of Termination for Default sent to the contractor, terminate the contract in whole or in part, without compensation to the contractor.

(ii) Such termination shall not prejudice or affect the rights and remedies, including under sub-clause below, which have accrued and/ or shall accrue to MDL after that.

(iii) Unless otherwise instructed by MDL, the contractor shall continue to perform the contract to the extent not terminated. All warranty obligations, if any, shall continue to survive despite the termination.

**(d) Contractual Remedies for Breaches/Defaults or Termination for Default**

If there is an unsatisfactory resolution within this period, MDL shall take one; or more of the following contractual remedies.

(i) Temporary withhold payments due to the contractor till recoveries due to invocation of other contractual remedies are complete.

(ii) Call back any loaned property or advances of payment, if any, with the levy of interest at the prevailing rate (MIBID - Mumbai Interbank Bid Rate).

(iii) Recover liquidated damages and invoke denial clause for delays.

(iv) Encash and/ or Forfeit performance or other contractual securities.

(v) Prefer claims against insurances, if any.

(vi) Terminate contract for default, fully or partially including its right for Risk and- Cost Procurement as per following sub-clause.

**(vii) Risk and Cost Procurement**

In addition to termination for default, MDL shall be entitled, and it shall be lawful on his part, to procure Goods same to those terminated, with such terms and conditions and in such manner as it deems fit at the "Risk and Cost" of the contractor. Such 'Risk and Cost Procurement' must be initiated (viz. AIP/PR/Tender) within six months from the termination of Contract. The Contractor shall be liable for any loss which MDL may sustain on that account provided the procurement, or, if there is an agreement to procure, such agreement is made. The Contractor shall not be entitled to any gain on such procurement, and the manner and method of such procurement shall be in the entire discretion of MDL. (Note: deleted being contrary to law). (Note: No contractor would give security after the termination of the contract)

Note: Regarding the Goods which are not readily available in the market and where procurement difficulties are experienced, the period for making risk procurement shall be nine months instead of six months provided above.

(viii) Initiate legal proceedings in a for the recovery of the losses and damages, not addressable by the above means.

**9. CLOSURE OF CONTRACT**

The contract shall stand closed upon successful performance of all obligations by the firm, including completion of warrantee obligations and final payment. If no claim is received within 03 years from last supplies/services, then no claim shall be entertained thereafter.

**10. COMMUNICATION AND LANGUAGE FOR DOCUMENTATION**

Any letter, facsimile message, e-mail intimation or notice sent to the Bidder/Supplier/ Contractor at the last known address mentioned in the offer / order shall be deemed to be valid communication for the purpose of the order/contract. Unless stated otherwise by the purchaser, Language for communication and all documentation shall be same, which the Purchaser has used, in the tender enquiry.

**11. PRESERVATION AND MAINTENANCE**

Should any material require any preservation till its final installation/fitment, the detailed procedure (Long term and short term) for the same as also the time of interval after which the state of preservation needs to be reviewed is to be stated by the Bidder/Supplier/Contractor.

Further the de-preservation prior to the material/equipment being commissioned and the maintenance procedure together with its periodicity is also to be indicated by the Bidder/ Supplier / Contractor.

**12. FREIGHT AND INSURANCE.**

**(a) For Indigenous Bidders**

Bidder shall quote for 'Door Delivery to Purchaser,' all charges towards door delivery viz. transport, Insurance charges etc. shall be borne by the Bidder /Supplier / Contractor.

**(b) For Foreign Bidders**

~~For overseas bidders, bidder shall agree for supplying the goods on CIF/CIP, Incoterm basis. The Bidder / Supplier / Contractor shall immediately on despatch of the items, inform all relevant details of despatch such as Order Number, Bill of Lading/AWB Number marked as Freight Paid, Insurance policy/document, number of packages, value of consignment, invoice number etc. as per contractual terms.~~

**13. DEMURRAGE**

Storage, and Demurrage, fines etc. charges will be payable by the Bidder / Supplier / Contractor for all shipments in case of improper documentation, wrong declarations, error in weight measurements, packing list, invoice, late receipt of documents etc. i.e. for reasons which are not attributable to the purchaser.

**14. CANCELLATION OF TENDER**

The Purchaser reserves the right to cancel/withdraw the tender in toto or part and or award the contract / order in full or part without assigning any reason whatsoever and without thereby incurring any liability to the affected Bidder or Bidders or any obligations to inform the affected Bidder or Bidders of the grounds for MDL action.

**15. PURCHASER'S PROPERTY.**

All property (such as materials, drawings, documents etc.) issued by the Purchaser or any other individual or firm on behalf of the Purchaser in connection with the contract shall remain confidential, being the property of the Purchaser and the Bidder/Supplier/Contractor shall undertake to return all such property so issued and will be responsible for any or all loss thereof and damage thereto resulting from whatever causes and shall reimburse the Purchaser the full amount of loss and damage.

On completion of work in any compartment / location of the purchaser's premises, the Bidder/Supplier/Contractor must ensure that the place is left in a reasonably clean state and all scrap is transferred to nearby scrap-bins.

**16. REJECTION OF MATERIALS**

If the Goods, or any portion thereof of the equipment found defective / rejected, the Supplier / Contractor shall collect the same from MDL's Stores, all incidental charges being borne by him (inclusive of Custom duty, if payable), within 30 days from the date of intimation to the Supplier / Contractor of such rejection. If not collected within 30 days, MDL shall recover storage charges @ 1 % per month maximum up to 5% of cost of rejected items. MDL reserves the right to dispose-off the rejected items at the end of a total period of six months in any manner to the best advantage to MDL and recover consequential damages maximum up to order value.

**17. RECOVERY-ADJUSTMENT PROVISIONS**

Payment made under one order shall not be assigned or adjusted to any other order except to the extent agreed upon in writing by the Purchaser. During the currency of the contract, if any sum of money is payable by the Bidder / Supplier / Contractor the same shall be deducted from any sum then due or thereafter may become due to the Bidder / Supplier / Contractor under the contract or any other contract with the Purchaser.

**18. INDEMNIFICATION**

The Bidder / Supplier / Contractor, his employees, licences, agents or Sub-Supplier / Sub-contractor, while on site of the Purchaser for the purpose of this contract, indemnifies the Purchaser against direct damage and/or injury to the property and/or the person of the Purchaser or that of Purchaser's employees, agents, Sub- Contractors / Suppliers occurring and to the extent caused by the negligence of the Bidder / Supplier / Contractor, his employees, licensees, agents or Sub-contractor by making good such damages to the property, or compensating personal injury and the total liability for such damages or injury shall be as mutually discussed and agreed to.

**19. TRANSFER OF SUPPLIERS / CONTRACTOR'S RIGHTS**

The Bidder / Supplier / Contractor shall not either wholly or partly sell, transfer, assign or otherwise dispose of the rights, liabilities and obligations under the contract between him and the Purchaser without prior consent of the Purchaser in writing.

## **20. SUBCONTRACT AND RIGHT OF PURCHASER**

The Bidder / Supplier / Contractor under no circumstances undertake or subcontract any work / contract from or to any other Sub-contractor without prior written approval of the Competent Authority of Purchaser. In the event it is found that such practice has been indulged in, the contract is liable to be terminated without notice and the Bidder / Supplier / Contractor is debarred all from future tender enquiries / work orders. However, in no circumstances a contractor is permitted to subcontract any part of the contract to the bidders who had quoted for the concerned tender.

## **21. PATENT RIGHTS**

The Bidder / Supplier / Contractor shall hold harmless and keep the Purchaser indemnified against all claims arising as a result of infringement of any patent / copy rights on account of manufacture, sale or use of articles covered by the order.

## **22. AGENTS/AGENCY COMMISSION**

The seller confirms and declares to the buyer that the seller is the original manufacturer or authorized distributor/stockiest of original manufacturer of the goods referred to in this contract and has not engaged any individual or firm, whether Indian or foreign whatsoever, to intercede, facilitate or in any way to recommended to the Buyer or any of its functionaries, whether officially or unofficially , to the award of the Contract / Purchase order to the Seller; nor has any amount been paid, promised or intended to be paid to any such individual or firm in respect of any such intercession, facilitation or recommendation. The Seller agrees that if it is established at any time to the satisfaction of the Buyer that the present declaration is in any way incorrect or if at a later stage it is discovered by the Buyer that the Seller has engaged any such individual/firm, and paid or intended to pay any amount, gift, reward , fees, commission or consideration to such person, party, firm or institution , whether before or after the signing of this Contract / Purchase order, the Seller will be liable to refund that amount to the Buyer. The seller will also be debarred from participation in any RFQ/Tender for new projects/program with Buyer for a minimum period of five years. The buyer will also have a right to consider cancellation of the Contract either wholly or in part, without any entitlement or compensation to the Seller who shall in such event be liable to refund all payments made by the buyer in terms of the Contract along with interest at the rate of 2% per annum or 6% whichever is higher above LIBOR (London Inter Bank Offer Rate) (for foreign vendors) and base rate of SBI plus 2% (for Indian Vendors). The Buyer will also have the right to recover any such amount from any contracts concluded earlier with Buyer.

## **23. USE OF UNDUE INFLUENCE / CORRUPT PRACTICES**

The Bidder / Supplier / Contractor undertakes that he has not used corrupt practices or used any undue influence which is not admissible as per Indian law to obtain contract/order or in doing any business with the purchaser. If found that Bidder / Supplier / Contractor is involved in such wrong practices, then Purchaser is entitled to cancel the contract/s and all or any other contracts and then to recover from the Bidder / Supplier / Contractor the amounts of any loss arising from such contracts' cancellation, including but not limited to imposition of penal damages, forfeiture of Performance security, encashment of the Bank Guarantee and refund of the amounts paid by the Purchaser.

## **24. IMMUNITY OF GOVERNMENT OF INDIA CLAUSE**

It is expressly understood and agreed by and between M/s. (Bidder / Supplier / Contractor) and Mazagon Dock Shipbuilders Limited, Dockyard Road, Mumbai – 400 010 (MDL) is entering into this Agreement solely on its own behalf and not on the behalf of any person or entity. In particular, it is expressly understood and agreed that the Government of India is not a party to this Agreement and has no liabilities, obligations or rights hereunder. It is expressly understood and agreed that MDL is an independent legal entity with power and authority to enter into contracts solely in its own behalf under the applicable of Laws of India and general principles of Contract Law. The (Bidder / Supplier / Contractor) expressly agrees, acknowledges and understands that MDL is not an agent, representative or delegate of the Government of India. It is further understood and agreed that the Government of India is not and shall not be liable for any acts, omissions and commissions, breaches or other wrongs arising out of the contract. Accordingly, (Bidder / Supplier / Contractor) hereby expressly waives,

releases and foregoes any and all actions or claims, including cross claims, impleader claims or counter claims against the Government of India arising out of this contract and covenants not to sue Government of India in any manner, claim, cause of action or thing whatsoever arising of or under this Agreement.

## **25. EXPORT LICENCE**

The export licenses that may be required for delivery of the various items/equipment to MDL shall be arranged by the Bidder / Supplier / Contractor from the concerned authorities in their country without any time and cost implications on the Purchaser.

## **26. BANNED OR DE-LISTED CONTRACTORS / SUPPLIERS**

The Bidder / Supplier / Contractor declares that they being Proprietors / Directors / Partners have not been any time individually or collectively blacklisted or banned or de-listed by any Government or quasi Government agencies or PSUs. If a bidder's entities as stated above have been blacklisted or banned or de-listed by any Government or quasi Government agencies or PSUs, this fact must be clearly stated and it may not necessarily be a cause for disqualifying him.

## **27. DUTY OF PERSONNEL OF SUPPLIER/CONTRACTOR**

MDL being a Defence Public Sector Undertaking, Bidder / Supplier / Contractor undertakes that their personnel deployed in connection with the entrusted work will not indulge in any activities other than the duties assigned to them.

## **28. DISPUTE RESOLUTION MECHANISM AND ARBITRATION**

### **(a) Dispute resolution mechanism(DRM)**

(i) Any dispute/differences between the parties arising out of and in connection with the contract shall be settled amicably by mutual negotiations at HoS/HoD level.

(ii) In case of non-settlement by (i) above, if at any time, before, during or after the contract period any unsettled claim, dispute or difference arose between the parties, upon or in relation to or in connection with or in any way touching or concerning this tender/agreement/order/contract, the same shall be referred to the concerned Functional Director. The Functional Director shall then nominate an Executive of the rank of General Manager whom he thinks fit and competent or a Committee of Executives who/which shall then scrutinise the claims/disputes that have been referred to the concerned functional Director and make efforts for amicable settlements by mutual discussions/negotiations.

(iii) In case no amicable settlement is arrived by (ii) above within a period of three months, then the contractor shall approach Public Grievance Cell and address the disputes as per the provisions made under the relevant clause of the contract.

(iv) In case the issues/disputes do not get settled within a period of six months from the date of submission of the dispute to the Grievance Cell, then the contractor may invoke Arbitration Clause of the contract.

### **(b) Arbitration**

Unresolved disputes/differences, if any, shall then be settled by Arbitration. The Arbitration proceedings shall be conducted at Mumbai, India, in English Language, under the Arbitration and Conciliation Act, 1996 as amended from time to time and the rules thereunder. MDL prefers to have arbitration through Institutes such as Indian Council of Arbitration (ICA)/ICA-DR, Mumbai Centre for International Arbitration, International Chamber of Commerce (ICC), Singapore International Arbitration Centre (SIAC) with the mutual consent of the parties. In case of unresolved difference/dispute between the Purchaser and Supplier, being Central Public Sector Enterprises/Central Govt. departments, the disputes shall be resolved firstly through mutual discussion or through the empowered agencies of the Govt. or through arbitration by reference by either party to the department of Public Enterprises, as per extant guidelines. If disputes/differences remain unresolved/unexecuted, the same shall be referred first to the Cabinet Secretariat and then, if necessary to the PMO. Any changes to arbitration clause must be vetted by HOD (Legal) before incorporation in contract/PO.

## **29. JURISDICTION OF COURTS**

All contracts shall be deemed to have been wholly made in Mumbai and all claims there under are payable in Mumbai City and it is the distinct condition of the order that no suit or action for the purpose

of enforcing any claim in respect of the order shall be instituted in any Court other than that situated in Mumbai City, Maharashtra State, India i.e. courts in Mumbai shall alone have jurisdiction to decide upon any dispute arising out of or in respect of the contract.

### **30. SAFETY**

The Contractor / Bidder must observe all safety precautions in connection with the work to be performed by him, his agents or labourers. In the event of any accident happening in our yard resulting in loss of lives or otherwise damaging any part of the property, the contractor shall be required to make good the loss to the Company and shall be responsible for all consequences that follow from the loss and / or injuries to the persons involved in such accidents. The standard of safety to be observed in the Company shall be decided by the Executive-in-Charge Safety, or any Executive appointed for the purpose before the commencement of work in the yard. It will be essential for contractor to ascertain the standard precautions which contractor is required to observe in discharging his work as per the standards prevalent in MDL. The decision of MDL in matters concerning Safety shall be final and binding on the contractor. The Contractor / Bidder shall be required to provide his workmen with Boiler Suits of any suitable colour other than blue or white, with the Name of the Contractor in prominent letters on the boiler suits along with personal protection gears like safety shoes, hand gloves etc. workmen of the Contractor / Bidder must wear throughout their working while in the premises of MDL. Contractor's workmen working without safety gears are to be disallowed for work.

### **31. FORCE MAJEURE**

If at any time during the execution of the goods / service order, the performance in whole or in part by either Purchaser or and by the Bidder(s) / Supplier(s) / Contractor(s) is / are delayed by any reason of force majeure situations such as acts of civil war, civil commotion, sabotage, hostilities, war, fires, explosions, epidemics, natural calamities like floods, earthquakes, volcanoes, storms, acts of God and laws of respective governments or any other causes beyond the control of either parties, hereinafter referred to as "events", provided notice of the occurrence of such event/s is / are communicated by either party, to the other party within 21 days from the date of occurrence thereof, neither party shall by reason such events be entitled to terminate the contract nor shall either party have any claim for damages against the other in respect of such non-performance and or delay in performance of the contract / order. Executions on either side shall be resumed as soon as practicable after such event has come to an end or ceased to exist and the decision of Purchaser as to whether activities can resume or not, shall be conclusive and final. Occurrence of the events to be certified by Chamber of Commerce / Indian High Commission or Embassies / Government in that Country. The performance in whole or in part under the captioned tender / contract is prevented or delayed by reason of any such event for a period exceeding sixty days either party may at its option terminate the contract / further processing of the tender. The relative obligations of both the parties remain suspended during the actual period of force majeure. The Purchaser may extend the delivery schedule as mutually agreed, on receipt of written communication from the Bidder / Supplier / Contractor regarding occurrence of 'Force Majeure' conditions, but not exceeding six months from the scheduled delivery date. If the 'Force Majeure' conditions extend beyond this period, the Purchaser shall have the right to cancel the order without any financial implication to the Purchaser or on terms mutually agreed to.

-----



**Enclosure-4****ACCEPTANCE FORM FOR GENERAL CONDITIONS OF CONTRACT (GCC)**

| GCC<br>CLAUSE<br>No. | BIDDER'S<br>REMARK | GCC<br>CLAUSE<br>No. | BIDDER'S<br>REMARK | GCC<br>CLAUSE<br>No. | BIDDER'S<br>REMARK |
|----------------------|--------------------|----------------------|--------------------|----------------------|--------------------|
|                      | ACC/DEV            |                      | ACC./ DEV          |                      | ACC/ DEV           |
| 1                    | ACC/DEV            | 2                    | ACC/DEV            | 3                    | ACC/DEV            |
| 4                    | ACC/DEV            | 5                    | ACC/DEV            | 6                    | ACC/DEV            |
| 7                    | ACC/DEV            | 8                    | ACC/DEV            | 9                    | ACC/DEV            |
| 10                   | ACC/DEV            | 11                   | ACC/DEV            | 12                   | ACC/DEV            |
| 13                   | ACC/DEV            | 14                   | ACC/DEV            | 15                   | ACC/DEV            |
| 16                   | ACC/DEV            | 17                   | ACC/DEV            | 18                   | ACC/DEV            |
| 19                   | ACC/DEV            | 20                   | ACC/DEV            | 21                   | ACC/DEV            |
| 22                   | ACC/DEV            | 23                   | ACC/DEV            | 24                   | ACC/DEV            |
| 25                   | ACC/DEV            | 26                   | ACC/DEV            | 27                   | ACC/DEV            |
| 28                   | ACC/DEV            | 29                   | ACC/DEV            | 30                   | ACC/DEV            |
| 31                   | ACC/DEV            |                      | ACC/DEV            |                      | ACC/DEV            |

COMPANY'S NAME & ADDRESS:

\_\_\_\_\_  
 \_\_\_\_\_  
 \_\_\_\_\_

SIGNATURE:  
 DATE:  
 NAME:  
 DESIGNATION:  
 BIDDER'S COMPANY SEAL:

**NOTES:**

1. Bidders should carefully read the General Terms & Conditions (GCC) of the Tender Enquiry prior to filling up this acceptance format.
2. This format should be properly filled, signed and returned by the bidder(s) along with their technical offer for considering their Bid.
3. Bidder(s) should indicate "ACC" for Accepted, "DEV" for Deviation Taken for each clause number in the above table.
4. Bidder(s) to attach Separate Sheet indicating all relevant details such as Number & description of the Clause, Reasons for Deviation and Alternative suggested for any deviations taken by them.
5. **Clause numbers shown in the above format also includes the sub-clauses under these clauses. For example, Clause no. '8' means – Clause nos.-8.1, 8.2, 8.3.**

-----

**Enclosure-5**

**Declaration of Compliance on Restrictions under Rule 144 (xi) of the General Financial Rules (GFRs), 2017**

**Restriction under rule 144( xi) of GFR**

- I. Any bidder from a country which shares a land border with India will be eligible to bid in any procurement whether of goods, services (including consultancy services and non-consultancy services) or works (including turnkey projects) only if the bidder is registered with the Competent Authority. Further, any bidder (including bidder from India) having specified Transfer of Technology (TOT) arrangement with an entity from a country which shares a land border with India, shall also require to be registered with the same competent authority.
- II. "Bidder" (including the term 'tenderer', 'consultant' or 'service provider' in certain contexts) means any person or firm or company, including any member of a consortium or joint venture (that is an association of several persons, or firms or companies), every artificial juridical person not falling in any of the descriptions of bidders stated hereinbefore, including any agency branch or office controlled by such person, participating in a procurement process.
- III. "Bidder (or entity) from a country which shares a land border with India" for the purpose of this Order means: -
  - (a) An entity incorporated, established or registered in such a country; or
  - (b) A subsidiary of an entity incorporated, established or registered in such a country; or
  - (c) An entity substantially controlled through entities incorporated, established or registered in such a country; or
  - (d) An entity whose beneficial owner is situated in such a country; or
  - (e) An Indian (or other) agent of such an entity; or

(f) A natural person who is a citizen of such a country; or

(g) A consortium or joint venture where any member of the consortium or joint venture falls under any of the above.

IV. The beneficial owner for the purpose of (iii) above will be as under:

1. In case of a company or Limited Liability Partnership, the beneficial owner is the natural person(s), who, whether acting alone or together, or through one or more juridical person, has a controlling ownership interest or who exercises control through other means.

Explanation—

- a. "Controlling ownership interest" means ownership of or entitlement to more than twenty-five per cent. of shares or capital or profits of the company;
  - b. "Control" shall include the right to appoint majority of the directors or to control the management or policy decisions including by virtue of their shareholding or management rights or shareholder's agreements or voting agreements;
2. In case of a partnership firm, the beneficial owner is the natural person(s) who, whether acting alone or together, or through one or more juridical person, has ownership of entitlement to more than fifteen percent of capital or profits of the partnership;
  3. In case of an unincorporated association or body of individuals, the beneficial owner is the natural person(s), who, whether acting alone or together, or through one or more juridical person, has ownership of or entitlement to more than fifteen percent of the property or capital or profits of such association or body of individuals;
  4. Where no natural person is identified under (1) or (2) or (3) above, the beneficial owner is the relevant natural person who holds the position of senior managing official;
  5. In case of a trust, the identification of beneficial owner(s) shall include identification of the author of the trust, the trustee, the beneficiaries with fifteen percent or more interest in the trust and any other natural person exercising ultimate effective control over the trust through a chain of control or ownership.

V. An Agent is a person employed to do any act for another, or to represent another in dealings with third person.

VI. The successful bidder shall not be allowed to sub-contract works to any contractor from a country which shares a land border with India unless such contractor is registered with the Competent Authority.

VII. The registration shall be valid at the time of submission of bid and at the time of acceptance of bid.

VIII. If the bidder was validly registered at the time of acceptance I placement of order, registration shall not be a relevant consideration during contract execution.

**Note: Model certificate for the same is attached at the following page.**

**Model Certificate:**

**DECLARATION BY AUTHORISED SIGNATORY OF THE FIRM**

"I..... have read the clause regarding restrictions on procurement from a bidder of a country which shares a land border with India. I certify that this bidder is not from such a country or, if from such a country, has been registered with the Competent Authority.

I hereby certify that this bidder fulfills all requirements in this regard and is eligible to be considered. [Where applicable, evidence of valid registration by the Competent Authority shall be attached.]"

**AUTHORISED SIGNATURE:** \_\_\_\_\_

**DATE:** \_\_\_\_\_

**Seal / Stamp of Bidder**

**Model additional certificate by Bidders in the cases of specified TOT:**

**DECLARATION BY AUTHORISED SIGNATORY OF THE FIRM**

I have read the clause regarding restrictions on procurement from a bidder having Transfer of Technology (TOT) arrangement I certify that this bidder does not have any TOT arrangement requiring registration with the competent authority.

OR

I have read the clause regarding restrictions on procurement from a bidder having Transfer of Technology (TOT) arrangement. I certify that this bidder has valid registration to participate in this procurement.

**AUTHORISED SIGNATURE:** \_\_\_\_\_

**DATE:** \_\_\_\_\_

**Seal / Stamp of Bidder**

**DECLARATION CERTIFICATE FOR LOCAL CONTENT**  
**(Tender value Less than Rs 10 Crores)**

This declaration must form part of all tenders & it contains general information and serves as a declaration form for all bidders. (Before completing this declaration, bidders must study the General Conditions, Definitions, Govt Directives applicable in respect of Local Content & prescribed tender conditions).

**LOCAL CONTENT DECLARATION BY CHIEF FINANCIAL OFFICER OR OTHER LEGALLY RESPONSIBLE PERSON NOMINATED IN WRITING BY THE CHIEF EXECUTIVE OR SENIOR MEMBER/PERSON WITH MANAGEMENT RESPONSIBILITY (CORPORATION, PARTNERSHIP OR INDIVIDUAL)**

**IN RESPECT OF BID / TENDER No.** .....  
**ISSUED BY:** (Name of Firm):.....

NB: The obligation to complete, duly sign and submit this declaration cannot be transferred to an external authorized representative, auditor or any other third party acting on behalf of the bidder.

I, the undersigned, ..... (full names),  
do hereby declare, in my capacity as .....  
of .....(name of bidder  
entity), the following:

(a) The facts contained herein are within my own personal knowledge.

(b) I have read and understood the requirement of local content (LC) and same is specified as percentage calculated in accordance with the definition provided at clause 2 of revised Public Procurement (preference to Make in India) Order 2017.

"Local content" as per above order means the amount of value added in India which shall be the total value of items procured (excluding net domestic indirect taxes) minus the value of imported content in the item (including all customs duties) as a proportion of the total value in percent."

(c) I have satisfied myself that the goods/services/works to be delivered in terms of the above-specified bid comply with the local content requirements as specified in the tender for 'Class-I Local Supplier' / 'Class-II Local Supplier', and as above.

(d) I understand that a bidder can seek benefit of either Public Procurement Policy for MSEs –Order 2012 or Public Procurement (preference to Make in India) Order 2017 and not both and once the option is declared / selected it is not permitted to be modified subsequently. Accordingly, I seek the benefit from the below declared purchase preference policy only.



i) I seek benefits against the following policy only (Select only one Option):

1) PPP MSE Order 2012  (applicable for MSE manufacturers)

2) PPP MII 2017  (applicable for Class I suppliers as well as MSE manufacturers)

(Note: If not declared / selected it shall be deemed that purchase preference benefit is sought under PPP MII 2017 policy. However, selection of both the options will be treated as ambiguous and will result in rejection of bid)

(e) The local content calculated using the definition given above are as under:

| Tender Item<br>Sr No | Local content calculated<br>as above % | Location of local value addition<br>(Location shall be the specified as name of city or district,<br>etc. Location as name of country will be considered as<br>ambiguous and such bids shall be rejected.) |
|----------------------|--|--|
|                      |  |  |
|                      |  |  |

Attach separate sheet duly signed if space is not sufficient

NB: Local content percentage shall be declared item wise or tender wise strictly as per the terms of the tender.

(f) I accept that the Procurement Authority / Institution / MDL / Nodal Ministry has the right to request that the local content be verified in terms of the requirements of revised Public Procurement (preference to Make in India) Order 2017 dtd 16.09.2020 and I shall furnish the document / information on demand. Failure on my part to furnish the data will be treated as false declaration as per PPP MII Order 2017. In case of contract being awarded, I undertake to retain the relevant documents for 7 years from date of execution.

(g) I understand that the submission of incorrect data, or data that are not verifiable as described in revised Public Procurement (preference to Make in India) Order 2017, may result in the Procurement Authority / Nodal Ministry / MDL imposing any or all of the remedies as provided for in Clause 9 of the Revised Public Procurement (preference to Make in India) Order 2017 dated 16.09.2020

SIGNATURE: \_\_\_\_\_

DATE: \_\_\_\_\_

Seal / Stamp of Bidder



**DECLARATION CERTIFICATE FOR LOCAL CONTENT**  
**(Tender value More than Rs 10 Crores)**

This declaration must form part of all tenders & it contains general information and serves as a declaration form for all bidders. (Before completing this declaration, bidders must study the General Conditions, Definitions, Govt Directives applicable in respect of Local Content & prescribed tender conditions).

**THE BIDDERS SHALL PROVIDE THIS CERTIFICATE FROM STATUTORY AUDITOR OR COST AUDITOR OF THE COMPANY (IN CASE OF COMPANIES) OR FROM A PRACTICING COST ACCOUNTANT OR PRACTICING CHARTED ACCOUNTANT (IN RESPECT OF SUPPLIER OTHER THAN COMPANIES) GIVING THE PERCENTAGE OF LOCAL CONTENT.**

**IN RESPECT OF BID / TENDER No.** .....  
**ISSUED BY: (Name of Firm):**.....

I, the undersigned, ..... (full names),  
do hereby declare, in my capacity as .....  
of .....(name of bidder  
entity), the following:

(a) The facts contained herein are within my own personal knowledge.

(b) I have read and understood the requirement of local content (LC) and same is specified as percentage calculated in accordance with the definition provided at clause 2 of revised Public Procurement (preference to Make in India) Order 2017.

“Local content” as per above order means the amount of value added in India which shall be the total value of items procured (excluding net domestic indirect taxes) minus the value of imported content in the item (including all customs duties) as a proportion of the total value in percent.”

(c) I have satisfied myself that the goods/services/works to be delivered in terms of the above-specified bid comply with the local content requirements as specified in the tender for 'Class-I Local Supplier' / 'Class-II Local Supplier', and as above.

(d) I understand that a bidder can seek benefit of either Public Procurement Policy for MSEs –Order 2012 or Public Procurement (preference to Make in India) Order 2017 and not both and once the option is declared / selected it is not permitted to be modified subsequently. Accordingly, I seek the benefit from the below declared purchase preference policy only.

i) I seek benefits against the following policy only (**Select only one Option**):

1) PPP MSE Order 2012  (applicable for MSE manufacturers)

2) PPP MII 2017  (applicable for Class I suppliers as well as MSE manufacturers)

(Note: If not declared / selected it shall be deemed that purchase preference benefit is sought under PPP MII 2017 policy. However, selection of both the options will be treated as ambiguous and will result in rejection of bid)



(e) The local content calculated using the definition given above are as under:

| Tender Item<br>Sr No | Local content calculated<br>as above % | Location of local value addition<br>(Location shall be the specified as name of city or district,<br>etc. Location as name of country will be considered as<br>ambiguous and such bids shall be rejected.) |
|----------------------|--|--|
|                      |  |  |
|                      |  |  |

Attach separate sheet duly signed if space is not sufficient

NB: Local content percentage shall be declared item wise or tender wise strictly as per the terms of the tender.

(f) I accept that the Procurement Authority / Institution / MDL / Nodal Ministry has the right to request that the local content be verified in terms of the requirements of revised Public Procurement (preference to Make in India) Order 2017 dtd 16.09.2020 and I shall furnish the document / information on demand. Failure on my part to furnish the data will be treated as false declaration as per PPP MII Order 2017. In case of contract being awarded, I undertake to retain the relevant documents for 7 years from date of execution.

(g) I understand that the submission of incorrect data, or data that are not verifiable as described in revised Public Procurement (preference to Make in India) Order 2017, may result in the Procurement Authority / Nodal Ministry / MDL imposing any or all of the remedies as provided for in Clause 9 of the Revised Public Procurement (preference to Make in India) Order 2017 dated 16.09.2020

**SIGNATURE:** \_\_\_\_\_

**DATE:** \_\_\_\_\_

**Seal / Stamp of Bidder**

**ACTUAL LOCAL CONTENT CERTIFICATE**  
**(Tender value Less than Rs 10 Crores)**

Note 1: This certificate shall be submitted by the successful bidder post execution of the contract.

**LOCAL CONTENT DECLARATION (post execution of contract / PO) BY CHIEF FINANCIAL OFFICER OR OTHER LEGALLY RESPONSIBLE PERSON NOMINATED IN WRITING BY THE CHIEF EXECUTIVE OR SENIOR MEMBER/PERSON WITH MANAGEMENT RESPONSIBILITY (CORPORATION, PARTNERSHIP OR INDIVIDUAL)**

**IN RESPECT OF CONTRACT No./ PO No.....**  
**ISSUED BY: (Name of Firm):.....**

NB: The obligation to complete, duly sign and submit this declaration cannot be transferred to an external authorized representative, auditor or any other third party acting on behalf of the bidder.

I, the undersigned, ..... (full names),  
do hereby declare, in my capacity as .....  
of ..... (name of bidder entity),  
that:

- (a) The facts contained herein are within my own personal knowledge.  
(b) My/our company had declared the local content at the time of tender as under

| Tender Item Sr No | Local content calculated as above % | Location of local value addition |
|-------------------|-------------------------------------|----------------------------------|
|                   |                                     |                                  |
|                   |                                     |                                  |

- (c) My / our company has completed the above referred contract and the actual local content of the delivered item/s calculated using the definition in the declaration given at the time of Bid is as under:

| Tender Item Sr No | Declared minimum Local content at the time of bidding (%) | Achieved Local content of delivered items (%) |
|-------------------|---|---|
|                   |   |   |
|                   |   |   |

NB: Local content percentage shall strictly be declared item wise or tender wise as was declared at the time of bid / tender.

- (d) I accept that the Procurement Authority / Institution / MDL / Nodal Ministry has the right to request that the local content be verified in terms of the requirements of revised Public Procurement (preference to Make in India) Order 2017 dated 16.09.2020 and I shall furnish the document / information on demand. Failure on my part to furnish the data will be treated as false declaration as per PPP MII Order 2017. I undertake to retain the relevant documents for 7 years from date of execution.

- (e) I understand that the submission of incorrect data, or data that are not verifiable as described in revised Public Procurement (preference to Make in India) Order 2017, may result in the Procurement Authority / Nodal Ministry / MDL imposing any or all of the remedies as provided for in Clause 9 of the Revised Public Procurement (preference to Make in India) Order 2017 dated 16.09.2020.

**SIGNATURE:** \_\_\_\_\_

**DATE:** \_\_\_\_\_

**Stamp / Seal of the company**



**ACTUAL LOCAL CONTENT CERTIFICATE**  
**(Tender value More than Rs 10 Crores)**

Note 1: This certificate shall be submitted by the successful bidder post execution of the contract.

**LOCAL CONTENT DECLARATION (post execution of contract / PO). THE SUPPLIER SHALL PROVIDE THIS CERTIFICATE FROM STATUTORY AUDITOR OR COST AUDITOR OF THE COMPANY (IN CASE OF COMPANIES) OR FROM A PRACTICING COST ACCOUNTANT OR PRACTICING CHARTED ACCOUNTANT (IN RESPECT OF SUPPLIER OTHER THAN COMPANIES) GIVING THE PERCENTAGE OF LOCAL CONTENT.**

**IN RESPECT OF CONTRACT No./ PO No.....**  
**ISSUED BY: (Name of Firm):.....**

I, the undersigned, ..... (full names),  
do hereby declare, in my capacity as .....  
of .....(name of bidder entity),  
that:

- (a) The facts contained herein are within my own personal knowledge.  
(b) My/our company had declared the local content at the time of tender as under

| Tender Item Sr No | Local content calculated as above % | Location of local value addition |
|-------------------|-------------------------------------|----------------------------------|
|                   |                                     |                                  |
|                   |                                     |                                  |

- (c) My / our company has completed the above referred contract and the actual local content of the delivered item/s calculated using the definition in the declaration given at the time of Bid is as under:

| Tender Item Sr No | Declared minimum Local content at the time of bidding (%) | Achieved Local content of delivered items (%) |
|-------------------|---|---|
|                   |   |   |
|                   |   |   |

NB: Local content percentage shall strictly be declared item wise or tender wise as was declared at the time of bid / tender.

(d) I accept that the Procurement Authority / Institution / MDL / Nodal Ministry has the right to request that the local content be verified in terms of the requirements of revised Public Procurement (preference to Make in India) Order 2017 dated 16.09.2020 and I shall furnish the document / information on demand. Failure on my part to furnish the data will be treated as false declaration as per PPP MII Order 2017. I undertake to retain the relevant documents for 7 years from date of execution.

(e) I understand that the submission of incorrect data, or data that are not verifiable as described in revised Public Procurement (preference to Make in India) Order 2017, may result in the Procurement Authority / Nodal Ministry / MDL imposing any or all of the remedies as provided for in Clause 9 of the Revised Public Procurement (preference to Make in India) Order 2017 dated 16.09.2020.

**SIGNATURE:** \_\_\_\_\_

**DATE:** \_\_\_\_\_

**Stamp / Seal of the company**

**EXTRACT OF PROVISIONS OF THE OFFICIAL SECRETS ACT, 1923****SECTION 2(B): "PROHIBITED PLACE"**

It is defined as the place of any work of Defence Dockyard and other so belonging or occupied and used for the purpose of building, repairing, making or storing any ammunitions of war.

For the purpose of the above definition, sketch includes any photograph or other mode of representing any place or thing.

**SECTION 3: "PENALTIES FOR SPYING"**

If any person unlawfully - approaches, inspects, passes over or is in the vicinity of any clear place; or make any sketches intended to be directly or indirectly useful to an enemy ; or c) Obtains collects records or communicates to any other person any secret official code.

Shall be liable for imprisonment of 14 years in case of Defence Installation.

**SECTION 4: "COMMUNICATION WITH FOREIGN AGENTS"**

If any person has been in communication with or attempted to communicate with foreign agents regarding the vital information of any "PROHIBITED PLACE" would be guilty of violating the provisions of this Act.

**SECTION 5: "WRONGFUL COMMUNICATION OF INFORMATION"**

If any person having in his possession or control any official document;

- a) Willfully communicates to any person, other than a person, who is authorised to communicate it.
- b) Used the information in his possession for the benefit of any foreign power.
- c) Retain in his possession when he has no power to retain it
- d) Fails to take reasonable care of it.

Shall be guilty of an offence under this Act.

**SECTION 6: "UNAUTHORISED USE OF UNIFORMS"**

If any person for the purpose of gaining admission or of assisting any other person to gain admission to a "PROHIBITED PLACE" wears uniforms without lawful authority shall be guilty of offence under this Section.

**SECTION 7: "INTERFERING WITH OFFICERS OF POLICE"**

No person in the vicinity of any "PROHIBITED PLACE" shall abstract any Police Officer engaged on guard, sentry or similar duty. If any people move in the provisions of this section, shall be punishable with imprisonment, which may extend up to 3 years.

**SECTION 8: "DUTY OF GIVING INFORMATION"**

It shall be duty of every person to give on demand to a superintendent of Police or any other Police Officer not below the rank of Inspector, any information in his power relating to an offence under this Act. If any person fails to give such information, shall be punishable with imprisonment to 3 years or fine or with both.

**SECTION 9: "INCITEMENT"**

Any person who attempts to commit or debate the commission of an offence under this Act shall be punishable with the same punishment and be liable to be proceeded against in the same manner as if he had committed such offence.

**SECTION 10: "PENALTY FOR HARBOURING SPIES"**

If any person whom he knows or has reasonable grounds for supposing to be person who is about to commit or who has committed offence under this Act shall be guilty of offence under this Section.

**SECTION 11: "SEARCH WARRANTS"**

If a presidency Magistrate, Magistrate First Class or Sub-Divisional magistrate is satisfied with the information that there is reasonable ground for suspecting that an offence under this Act has been or is about to be committed, he may grant search warrant to any Police Officer to enter at any time any premises to force to search premises or the places.

We accept and comply by the above clauses of EXTRACT OF PROVISIONS OF THE OFFICIAL SECRETS ACT, 1923.

Bidder's Signature.....

Bidder's Name.....

Company Seal.....

-----

**PROFORMA BANK GUARANTEE FOR PERFORMANCE SECURITY**

(On Non-Judicial stamp paper of value Rs. 500/- . However, the value of stamp paper to be confirmed from Legal Department, MDL.)

IN CONSIDERATION OF MAZAGON DOCK SHIPBUILDERS LIMITED, a company incorporated under the Companies Act 1956 and having its registered office at Dockyard Road, Mumbai 400010 (hereinafter referred to as the "the Purchaser" which expression shall, unless it be repugnant or contrary to the subject or context thereof, be deemed to mean and include its successors and assigns) having placed an order on Messers ..... a partnership firm/sole proprietor business/a company registered under the Companies Act, 1956 having its office at .....(hereinafter called " the Contractor/ Supplier" which expression shall, unless it be repugnant or contrary to the subject or context thereof, be deemed to mean and include its successors and assigns) vide order No..... dated..... (hereinafter called "the order" which expression shall include any amendments/alterations to "the order" issued by "the Purchaser") for the supply , delivery at site, installation and commissioning of certain equipment, item/services/civil works etc. as stated in the said Order and the Purchaser having agreed with the Contractor/Supplier to accept a Bank Guarantee in lieu of Performance Security payable under the said order for the fulfillment and performance of the said order, We, ..... Bank having office at ..... (hereinafter referred to as "the Bank" which expression shall include its successors and assigns) hereby agree to pay to the Purchaser without any demur on first demand an amount not exceeding Rs..... (Rupees.....only) being 5% (10% in case of Capital Procurement) of the order value against any loss or damage, costs, charges and expenses caused to or suffered by the Purchaser by reason of non performance and non-fulfillment or for any breach on the part of the Contractor / Supplier of any of the terms and conditions of the said order.

2. We, ..... Bank further agree that the Purchaser shall be sole judge whether the said Contractor/Supplier has failed to perform or fulfil the said order in terms thereof or committed breach of any terms and conditions of the order and the extent of loss, damage, cost, charges and expenses suffered or incurred or would be suffered or incurred by the Purchaser on account thereof and we waive in the favour of the Purchaser all the rights and defences to which we as guarantors may be entitled to.

3. We, ..... Bank further agree that the amount demanded by the Purchaser as such shall be final and binding on the Bank as to the Bank 's liability to pay and the amount demanded and the Bank undertake to pay the Purchaser the amount so demanded on first demand and without any demur notwithstanding any dispute raised by the Contractor/Supplier or any suit or other legal proceedings including arbitration pending before any court, tribunal or arbitrator relating thereto, our liability under this guarantee being absolute and unconditional.

4. We, ..... Bank further agree with the Purchaser that the Purchaser shall have the fullest liberty without our consent and without affecting in any manner our obligations hereunder to vary any of the terms and conditions of the said order/or to extend time of performance by the Supplier from time to time or to postpone for any time to time any of the powers exercisable by the Purchaser against the Contractor/ Supplier and to forbear to enforce any of the terms and conditions relating to the order and we shall not be relieved from our liability by reason of any such variation or extension being granted to the Contractor/ Supplier or for any forbearance, act or omission on the part of the Purchaser or any indulgence by the Purchaser to the Contractor/Supplier or by any such matter or things whatsoever which under the law relating to sureties would have the effect of relieving us.

5. We, ..... Bank further undertake not to revoke this guarantee during its currency except with the previous consent of the Purchaser in writing.

6. We, ..... Bank also agree that the Bank's liability under this guarantee shall not be affected by any change in the constitution of the Contractor / Supplier or dissolution or winding up of the business of the contractor/ supplier.

7. Notwithstanding anything contained herein above:

- i) Our liability under this guarantee shall not exceed Rs.....
- ii) This Bank Guarantee shall be valid upto and including .....; and
- iii) We are liable to pay the guarantee amount or any part thereof under this Bank Guarantee only and only if you serve upon us a written claim or demand on or before .....(validity + 4 weeks from the date of expiry of this guarantee).

8. This Guarantee shall be governed by Indian laws and the Courts at Mumbai, India shall have the exclusive jurisdiction.

IN WITNESS WHEREOF the Bank has executed this document on this.....day of.....

For ..... Bank

(by its constituted attorney)

(Signature of a person authorised to sign on behalf of "the Bank")

-----

**INTEGRITY PACT**

~~Mazagon Dock Shipbuilders Limited (MDL) hereinafter referred to as "The Principal/Buyer"~~

And

~~.....hereinafter referred to as "The Bidder/ Contractor"~~

Preamble

~~The Principal/Buyer intends to award, under laid down organizational procedures, contract/s for~~  
~~.....The Principal/Buyer values full compliance with all~~  
~~relevant laws of the land, rules, regulations, economic use of resources and of fairness / transparency in~~  
~~its relations with its Bidder(s) and /or Contractor(s).~~

~~In order to achieve these goals, the Principal/Buyer will appoint an Independent External Monitor (IEM),~~  
~~who will monitor the tender process and the execution of the contract for compliance with the principles~~  
~~mentioned above.~~

**Section 1 – Commitments of the Principal/Buyer:**

~~(1) The Principal/Buyer commits itself to take all measures necessary to prevent corruption and to~~  
~~observe the following principles:~~

~~a) No employee of the Principal/Buyer, personally or through family members, will in connection with the~~  
~~tender for, or the execution of a contract, demand, take a promise for or accept, for self or third person,~~  
~~any material or immaterial benefit which the person is not legally entitled to.~~

~~b) The Principal/Buyer will during the tender process treat all Bidder(s) with equity and reason. The~~  
~~Principal/Buyer will in particular, before and during the tender process, provide to all Bidder(s) the same~~  
~~information and will not provide to any Bidder(s) confidential/additional information through which the~~  
~~Bidder(s) could obtain an advantage in relation to the tender process or the contract execution.~~

~~c) The Principal/Buyer will exclude from the process all known prejudiced persons.~~

~~d) The Principal/Buyer undertakes to scrupulously follow the Purchase Manual containing Standard Terms~~  
~~& Conditions (STAC) and General Terms & Conditions (GT&C) in respect of procurement contracts for~~  
~~goods, services and civil works.~~

~~(1) — If the Principal/Buyer obtains information on the conduct of any of its employees which is a~~  
~~criminal offence under the relevant Anti-Corruption Laws of India, or if there be a substantive suspicion~~  
~~in this regard, the Principal/Buyer will inform the Chief Vigilance Officer, MDL and in addition can~~  
~~initiate disciplinary actions.~~

**Section 2 – Commitments of the Bidder(s)/Contractor(s):**

~~(1) The Bidder(s)/Contractor(s) commit himself to take all measures necessary to prevent corruption.~~  
~~He commits himself to observe the following principles during his participation in the tender process and~~  
~~during the contract execution:~~

*Bidder's Sign*.....

*Bidder's Stamp*.....

~~a) The Bidder(s)/Contractor(s) will not, directly or through any other persons or firm, offer promise or give to any of the Principal/Buyer's employees involved in the tender process or the execution of the contract or to any third person any material or other benefit which he/she is not legally entitled to, in order to obtain in exchange any advantage or any kind whatsoever during the tender process or during the execution of the contract.~~

~~b) The Bidder(s)/Contractor(s) will not enter with other Bidders into any undisclosed agreement or understanding, whether formal or informal. This applies in particular to prices, specifications, certifications, subsidiary contracts, submission or non-submission of bids or any other actions to restrict competitiveness or to introduce cartelization in the bidding process.~~

~~c) The Bidder(s)/Contractor(s) will not commit any offence under the relevant Anti-Corruption Laws of India; further the Bidder(s)/Contractor(s) will not use improperly, for purposes of competition or personal gain, or pass on to other, any information or document provided by the Principal/Buyer as part of the business relationship, regarding plans, technical proposals and business details, including information contained or transmitted electronically.~~

~~d) The Bidder(s)/Contractor(s) of foreign origin shall disclose the name and address of the Agents/representatives in India, if any. Similarly, the Bidder(s)/Contractor(s) of Indian Nationality shall furnish the name and address of the foreign principals, if any. All payments made to the Indian Agent/representative have to be in Indian Rupees only. Further details as mentioned in the "Guidelines of Indian Agents of Foreign suppliers" shall be disclosed by the Bidders(s)/Contractor(s). Copy of the "Guidelines on Indian Agents of Foreign Suppliers" as annexed and marked as Annexure A.~~

~~e) The Bidder(s)/Contractor(s) will when presenting his bid, disclose any and all payments he has made, is committed to or intends to make to agents, brokers or any other intermediaries in connection with the award of the contract.~~

~~f) The Bidder (s)/Contractor(s), their agents, representatives shall not do such things so as to interfere with the procedures laid down in the Principal/Buyer's Purchase Manual containing the Standard Terms and Conditions (STAC) and General Terms and Conditions (GT&C) in respect of procurement contracts for goods, services and civil works.~~

~~g) The Bidder commits to refrain from giving any complaint directly or through any other manner without supporting it with full and verifiable facts.~~

~~(2) The Bidder(s)/Contractor(s) will not instigate third persons to commit offences outlines above or be an accessory to such offences.~~

**Section 3 – Disqualification from tender process and exclusion from future contracts:**

~~If the Bidder(s)/Contractor(s) before contract award has committed a transgression through a violation of Section 2, above or in any other form such as to put his reliability or credibility as Bidder(s) in question, the Principal/Buyer is entitled to disqualify the Bidder(s)/Contractor(s) from the tender process or to terminate the contract, if already signed for such reason, as per the procedure mentioned in the "Guidelines on Banning of business dealings" Copy of the "Guidelines on Banning of business dealings" is annexed and marked as Annexure B.~~

*Bidder's Sign*.....

*Bidder's Stamp*.....



~~1) If the Bidder(s)/Contractor(s) has committed a transgression through a violation of Section 2 such as to put his reliability or credibility into question, the Principal/Buyer is entitled also to exclude the Bidder(s)/Contractor(s) from future contract award processes. The imposition and duration of the exclusion will be determined by the severity of the transgression. The severity will be determined by the circumstances of the case, in particular the number of transgressions, the position of the transgressors within the company hierarchy of the Bidder(s) and the amount of the damage. The exclusion will be imposed for a minimum of six months and maximum of five years, which may be further extended at the discretion of the Principal/Buyer.~~

~~2) A transgression is considered to have occurred, if the Principal/Buyer after due consideration of the available evidence, concludes that no reasonable doubt is possible.~~

~~3) The Bidder (s) accepts and undertakes to respect and uphold the Principal/Buyer's absolute right to resort to and impose such exclusion and further accepts and undertakes not to challenge or question such exclusion on any ground, including the lack of any hearing before the decision to resort to such exclusion is taken. This undertaking is given freely and after obtaining legal advice.~~

~~4) If the Bidder(s)/Contractor(s) can prove that he has restored/ recouped the damage caused by him and has installed a suitable corruption prevention system, the Principal/Buyer may revoke the exclusion prematurely.~~

**Section 4 – Sanctions for Violation:**

~~(1) Any breach of the aforesaid provisions by the Bidder or any one employed by him or acting on his behalf (whether with our without the knowledge of the Bidder) or the commission of any offence by the Bidder or any one employed by him or acting on his behalf, as defined in Chapter IX of the Indian Penal Code, 1860 or the Prevention of Corruption Act 1988 or any other Act enacted for the prevention of corruption shall entitle the Principal/Buyer to take all or any one of the following actions, wherever required—~~

~~a) To immediately call off the pre-contract negotiations without assigning any reason or giving any compensation to the Bidder. However, the proceedings with the other Bidder (s) would continue.~~

~~b) The Earnest Money Deposit/Security Deposit/Performance Bond shall stand forfeited either fully or partially, as decided by the Principal/Buyer, and the Principal/Buyer shall not be required to assign any reason there for.~~

~~c) To immediately cancel the contract, if already signed, without giving any compensation to the Bidder.~~

~~d) To recover all sums already paid by the Principal/Buyer, in case of an Indian Bidder with interest thereon at 2% higher than the prevailing Base Rate of SBI, and in case of a Bidder from a country other than India with interest thereon at 2% higher than the LIBOR. If any outstanding payment is due to the Bidder from the Buyer in connection with any other contract for any other Defence stores, such outstanding payment could also be utilized to recover the aforesaid sum and interest.~~

~~e) To encash the advance Bank Guarantee and Performance Bond/Warranty bond, if furnished by the Bidder, in order to recover the payments, already made by the Principal/Buyer, along with interest.~~

~~f) To cancel all or any other contracts with the Bidder.~~

~~g) To debar the Bidder from entering into any bid from Principal/Buyer for a minimum period of five years, which may be further extended at the discretion of the Principal/Buyer.~~

*Bidder's Sign*.....

*Bidder's Stamp*.....

~~h) To recover all sums paid in violation of this Pact by Bidder(s) to any middleman or agent or broker with a view to securing the contract.~~

~~i) If the Bidder or any employee of the Bidder or any person acting on behalf of the Bidder, either directly or indirectly, is closely related to any of the officers of the Buyer, or alternatively, if any close relative of an officer of the Buyer has financial interest/stake in the Bidder's firm, the same shall be disclosed by the Bidder at the time of filing of tender. Any failure to disclose the interest involved shall entitle the Buyer to rescind the contract without payment of any compensation to the Bidder.~~

~~The term 'close relative' for this purpose would mean spouse whether residing with the Principal/Buyer's employee/employees or not, but not include a spouse separated from the Principal/Buyer's employee/employees by a decree or order of a competent court; son or daughter or step son or step daughter and wholly dependent upon Principal/Buyer's employee/employees, but does not include a child or step child who is no longer in any way dependent upon the Principal/Buyer's employee/employees or of whose custody the Principal/Buyer's employee/employees has been deprived of by or under any law; any other person related, whether by blood or marriage, to the Principal/Buyer's employee/employees or to the Principal/Buyer's employee/employees wife or husband and wholly dependent upon Principal/Buyer's employee/employees.~~

~~j) The Bidder shall not lend to or borrow any money from or enter into any monetary dealings or transactions, directly or indirectly, with any employee of the Principal/Buyer, and if he does so, the Principal/Buyer shall be entitled forthwith to rescind the contract and all other contracts with the Bidder. The Bidder shall be liable to pay compensation for any loss or damage to the Principal/Buyer resulting from such rescission and the Principal/Buyer shall be entitled to deduct the amount so payable from the money(s) due to the Bidder.~~

~~k) In cases where Irrevocable Letters of Credit have been received in respect of any contract signed by the Principal/Buyer with the Bidder, the same shall not be opened.~~

~~(2) The decision of the Principal/Buyer to the effect that a breach of the provisions of this Integrity Pact has been committed by the Bidder shall be final and binding on the Bidder, however, the same Bidder can approach the Monitor(s) appointed for the purposes of this Pact.~~

**Section 5— Integrity Pact:**

~~1) The provisions regarding Sanctions for violation of Integrity Pact include forfeiture of Performance Bond in case of a decision by the Principal/Buyer to forfeit the same without assigning any reason for imposing sanction for violation of Integrity Pact.~~

~~2) No interest shall be payable by the Principal/Buyer to the Bidder(s) on Earnest Money/Security Deposit for the period of its currency.~~

**Section 6— Previous Transgression:**

~~(1) The Bidder declares that no previous transgressions occurred in the last three years with any other company in any country conforming to the anti-corruption approach or with any other public section enterprise in India that could justify his exclusion from the tender process.~~

~~(2) If the bidder makes incorrect statement on this subject, he can be disqualified from the tender process or further action can be taken.~~

*Bidder's Sign*.....

*Bidder's Stamp*.....

**Section 7 – Equal treatment of all Bidders/Contractor(s)/Subcontractors:**

- ~~(1) The Bidder(s)/Contractor(s) undertake(s) to demand from all subcontractors a commitment in conformity with this integrity Pact, and to submit it to the Principal before contract signing.~~
- ~~2) The Principal/Buyer will enter into agreements with identical conditions as this one with all bidders, contractors and subcontractors.~~
- ~~(3) The Principal/Buyer will disqualify from the tender process all bidders who do not sign this Pact or violate its provisions.~~

**Section 8 – Criminal charges against violation Bidder(s)/Contractor(s)/ Subcontractor(s):**

- ~~(1) If the Principal/Buyer obtains knowledge of conduct of a Bidder, Contractor or subcontractor, or of an employee or a representative or an associate of a Bidder, Contractor or subcontractor which constitutes corruption or if the Principal has substantive suspicion in this regard, the Principal/Buyer will inform the same to the Chief Vigilance Officer, MDL.~~

**Section 9 – Independent External Monitor/Monitors:**

- ~~(1) The Principal/Buyer appoints competent and credible independent External Monitor for this Pact. The task of the Monitor is to review independently and objectively whether and to what extent the parties comply with the obligations under this agreement.~~
- ~~(2) The Monitor is not subject to instructions by the representatives of the parties and performs his functions neutrally and independently. He reports to the Chairman & Managing Director of the Principal/Buyer.~~
- ~~(3) The Bidder(s)/Contractor(s) accepts that the Monitor has the right to access without restriction to all project documentation of the Principal/Buyer including that provided by the Contractor. The Contractor will also grant the Monitor, upon his request and demonstration of a valid interest, unrestricted and unconditional access to his project documentation. The same is applicable to Subcontractors. The Monitor is under contractual obligation to treat the information and documents of the Bidder(s)/Contractor(s)/Subcontractor(s) with confidentiality.~~
- ~~(4) The Principal/Buyer will provide to the Monitor sufficient information about all meetings among the parties related to the Project provided such meetings could have an impact on the contractual relations, between the Principal/Buyer and the Contractor. The parties offer to the Monitor the option to participate in such meetings.~~
- ~~(5) As soon as the Monitor notices, or believes to notice, a violation of this agreement, he will so inform the Management of the Principal/Buyer and request the Management to discontinue or take corrective action, or to take other relevant action. The Monitor can in this regard submit non-binding recommendations. Beyond this, the Monitor has no right to demand from the parties that they act in a specific manner, refrain from action or tolerate action. However, the Monitor shall give an opportunity to the Bidder(s)/Contractor(s) to present its case before making its recommendation to the Principal/Buyer.~~
- ~~(6) The Monitor will submit a written report to the Chairman & Managing Director of the Principal within 8 to 10 weeks from the date of reference or intimation to him by the Principal/Buyer and, should the occasion arise, submit proposals for correcting problematic situations.~~
- ~~(7) Monitor shall be entitled to compensation on the same terms as being extended to / provided to Independent Directors on the Board of Principal/Buyer.~~

*Bidder's Sign*.....

*Bidder's Stamp*.....

~~(8) If the Monitor has reported to the Chairman & Managing Director of the Principal, a substantiated suspicion of an offence under relevant Anti Corruption Laws of India and the Chairman & Managing Director of the Principal/Buyer has not, within the reasonable time taken visible action to proceed against such offence or reported it to the Chief Vigilance Officer, the Monitor may also transmit this information directly to the Central Vigilance Commissioner, Government of India.~~

~~(9) The word 'Monitor' would include both singular and plural.~~

**Section 10 — Pact Duration:**

~~This pact begins when both parties have legally signed it. It expires for the Contractor 12 months after the last payment under the contract and for all other Bidders 06 months after the contract has been awarded. If any claim is made / lodged during this time, the same shall be binding and continue to be valid despite the lapse of this pact as specified above unless it is discharged / determined by Chairman & Managing Director of the Principal/Buyer.~~

**Section 11 — Other provisions:**

~~(1) This agreement is subject to Indian Law, place of performance and jurisdiction is the Registered Office of the Principal/Buyer, i.e. Mumbai. The Arbitration clauses provided in the main tender document/ contract shall not be applicable for any issue/dispute arising under this Integrity pact.~~

~~(2) Changes and supplements as well as termination notices need to be made in writing. Side agreements have not been made.~~

~~(3) If the Contractor is a partnership or a consortium, this agreement must be signed by all partners or consortium members.~~

~~(4) Should one or several provisions of this agreement turn out to be invalid, the remainder of this agreement remains valid. In this case, the parties will strive to come to an agreement to their original intentions.~~

**Section 12 — Fall Clause: #**

~~"The Bidder undertakes that it has not supplied/is not supplying similar products/ systems or subsystems at a price lower than that offered in the present bid in respect of any other Ministry/Department of the Government of India or PSU and if it is found at any stage that similar product/systems or sub systems was supplied by the Bidder to any other Ministry/Department of the Government of India or a PSU at a lower price, then that very price, with due allowance of elapsed time, will be applicable to the present case and the difference in the cost would be refunded by the Bidder to the Principal/Buyer, if the contract has already been concluded."~~

\_\_\_\_\_

For & on behalf of

MAZAGON DOCK Shipbuilders LIMITED for & on behalf of Bidder/Contractor

(Office Seal) (Office Seal)

Place \_\_\_\_\_

Date \_\_\_\_\_

Witness 1: \_\_\_\_\_ Witness 2: \_\_\_\_\_

(Name & Address) \_\_\_\_\_ (Name & Address) \_\_\_\_\_

\_\_\_\_\_  
\_\_\_\_\_  
\_\_\_\_\_

**GUIDELINES FOR INDIAN AGENTS OF FOREIGN SUPPLIERS**

~~1.0 There shall be compulsory registration of agents for all Global (Open) Tender and Limited Tender. An agent who is not registered with MDL shall apply for registration.~~

~~1.1 An agent shall represent only one Foreign Supplier and not represent two suppliers or quote on their behalf in the same tender. However, either the Indian Agent on behalf of the Foreign Suppliers (also includes foreign manufacturers) or the Foreign Suppliers (also includes foreign manufacturers) directly could bid in a tender, but not both. In cases where an agent participates in a tender on behalf of one manufacturer, shall not quote on behalf of another manufacturer along with the first Manufacturer in a subsequent/parallel tender for the same item.~~

~~1.2 Registered agents will file an authenticated Photostat copy duly attested by a Notary Public/Original certificate of the principal confirming the agency agreement and giving the status being enjoyed by the agent and the commission/remuneration/salary/ retainer ship being paid by the principal to the agent before the placement of order by MDL.~~

~~1.3 Wherever the Indian representatives have communicated on behalf of their principals and the foreign parties have stated that they are not paying any commission to the Indian agents, and the Indian representative is working on the basis of salary or as retainer, a written declaration to this effect should be submitted by the party (i.e. Principal) before finalizing the order.~~

**2.0 DISCLOSURE OF PARTICULARS OF AGENTS/ REPRESENTATIVES IN INDIA, IF ANY.**

~~2.1 Tenderers of Foreign nationality shall furnish the following details in their offer:~~

~~2.1.1 The name and address of the agents/representatives in India, if any and the extent of authorization and authority given to commit the Principals. In case the agent/representative be a foreign Company, it shall be confirmed whether it is real substantial Company and details of the same shall be furnished.~~

~~2.1.2 The amount of commission/remuneration included in the quoted price(s) for such agents/representatives in India.~~

~~2.1.3 Confirmation of the Tenderer that the commission/ remuneration if any, payable to his agents/representatives in India, may be paid by MDL in Indian Rupees only.~~

~~2.2 Tenderers of Indian Nationality shall furnish the following details in their offers:~~

~~2.2.1 The name and address of the foreign principals indicating their nationality as well as their status, i.e, whether manufacturer or agents of manufacturer holding the Letter of Authority of the Principal~~

~~specifically authorizing the agent to make an offer in India in response to tender either directly or through the agents/representatives.~~

~~2.2.2 The amount of commission/remuneration included in the price (s) quoted by the Tenderer for himself.~~

~~2.2.3 Confirmation of the foreign principals of the Tenderer that the commission/remuneration, if any, reserved for the Tenderer in the quoted price (s), may be paid by MDL in India in equivalent Indian Rupees on satisfactory completion of the Project or supplies of Stores and Spares in case of operation items~~

~~2.3 In either case, in the event of contract materializing, the terms of payment will provide for payment of the commission /remuneration, if any payable to the agents/representatives in India in Indian Rupees on expiry of 90 days after the discharge of the obligations under the contract.~~

~~2.4 Failure to furnish correct and detailed information as called for in paragraph 2.0 above will render the concerned tender liable to rejection or in the event of a contract materializing, the same liable to termination by MDL. Besides this there would be a penalty of banning business dealings with MDL or damage or payment of a named sum. \_\_\_\_\_~~

**GUIDELINES ON BANNING OF BUSINESS DEALINGS****CONTENTS**

| <b>Sr.</b> | <b>Description</b>  | <b>Pages</b> |
|------------|---|--------------|
| 1.         | Introduction  | 2            |
| 2.         | Scope   | 2            |
| 3.         | Definitions   | 2-3          |
| 4.         | Initiation of Banning / Suspension  | 3            |
| 5.         | Suspension of Business Dealings   | 3-4          |
| 6.         | Ground on which Banning of Business Dealing can be initiated                      | 4-5          |
| 7.         | Banning of Business Dealings  | 5-6          |
| 8.         | Removal from List of Approved Agencies-Suppliers/ Contractors etc.                | 6            |
| 9.         | Procedure for issuing Show-cause Notice   | 6            |
| 10.        | Appeal against the Decision of the Competent Authority                            | 7            |
| 11.        | Review of the Decision by the Competent Authority                                 | 7            |
| 12.        | Circulation of the names of Agencies with whom Business Dealings have been banned | 7            |

**1. Introduction**

1.1 Mazagon Dock Shipbuilders Limited (MDL), being a Public Sector Enterprise and 'State', within the meaning of Article 12 of Constitution of India, has to ensure preservation of rights enshrined in Chapter III of the Constitution. MDL as also to safeguard its commercial interests. MDL deals with Agencies, who have a very high degree of integrity, commitments and sincerity towards the work undertaken. It is not in the interest of MDL to deal with Agencies who commit deception, fraud or other misconduct in the execution of contracts awarded / orders issued to them. In order to ensure compliance with the constitutional mandate, it is incumbent on MDL to observe principles of natural justice before banning the business dealings with any Agency.

1.2 Since banning of business dealings involves civil consequences for an Agency concerned, it is incumbent that adequate opportunity of hearing is provided and the explanation, if tendered, is considered before passing any order in this regard keeping in view the facts and circumstances of the case.

**2. Scope**

2.1 MDL reserves its rights to remove from list of approved suppliers / contractors or to ban business dealings if any Agency has been found to have committed misconduct and also to suspend business dealings pending investigation.

2.2 Similarly, in case of sale of material there is a clause to deal with the Agencies / customers / buyers, who indulge in lifting of material in unauthorized manner.

2.3 However, absence of such a clause does not in any way restrict the right of MDL to take action / decision under these guidelines in appropriate cases.

2.4 The procedure of (i) Removal of Agency from the List of approved suppliers / contractors; (ii) Suspension and (iii) Banning of Business Dealing with Agencies, has been laid down in these guidelines.

~~2.5 These guidelines apply to all the Divisions/Yards of MDL.~~

~~2.6 It is clarified that these guidelines do not deal with the decision of the Management not to entertain any particular Agency due to its poor / inadequate performance or for any other reason.~~

~~2.7 The banning shall be with prospective effect, i.e., future business dealings.~~

### ~~3. Definitions~~

~~In these Guidelines, unless the context otherwise requires:~~

- ~~i) 'Bidder / Contractor / Supplier / Purchaser / Customer' shall mean and include a public limited company or a private limited company, a firm whether registered or not, an individual, a cooperative society or an association or a group of persons engaged in any commerce, trade, industry, etc. 'Bidder / Contractor / Supplier / Purchaser / Customer' in the context of these guidelines is indicated as 'Agency'.~~
- ~~ii) 'Inter connected Agency' shall mean two or more companies having any of the following features:
 
  - ~~a) If one is a subsidiary of the other.~~
  - ~~b) If the Director(s), Partner(s), Manager(s) or Representative(s) are common;~~
  - ~~c) If management is common;~~
  - ~~d) If one owns or controls the other in any manner;~~~~
- ~~iii) 'Competent Authority' and 'Appellate Authority' shall mean the following:
 
  - ~~a) Functional Director shall be the 'Competent Authority' for the purpose of these guidelines. CMD, MDL shall be the 'Appellate Authority'.~~
  - ~~b) CMD, MDL shall have overall power to take suo moto action on any information available or received by him and pass such order(s) as he may think appropriate, including modifying the order(s) passed by any authority under these guidelines. Page No. 8.56 Amdt. No : 0 Date : 01/01/2015~~~~
- ~~iv) 'Investigating Department' shall mean any Department or Unit investigating into the conduct of the Agency and shall include the Vigilance Department, Central Bureau of Investigation, the State Police or any other department set up by the Central or State Government having powers to investigate.~~
- ~~v) 'List of approved Agencies' 'Bidder / Contractors / Suppliers / Purchasers / Customers shall mean and include list of approved / registered Agencies 'Bidder / Contractors / Suppliers / Purchasers / Customers, etc~~

### ~~4. Initiation of Banning / Suspension~~

~~Action for banning / suspension business dealings with any Agency should be initiated by the department having business dealings with them after noticing the irregularities or misconduct on their part. Besides the concerned department, Vigilance Department may also be competent to initiate such action.~~

### ~~5. Suspension of Business Dealings~~

~~5.1 If the conduct of any Agency dealing with MDL is under investigation by any department, the Competent Authority may consider whether the allegations under investigation are of a serious nature and whether pending investigation, it would be advisable to continue business dealing with the Agency. If the Competent Authority, after consideration of the matter including the recommendation of the Investigating Department, if any, decides that it would not be in the interest to continue business dealings pending investigation, it may suspend business dealings with the Agency. The order to this~~



~~effect may indicate a brief of the charges under investigation. If it is decided that inter-connected Agencies would also come within the ambit of the order of suspension, the same should be specifically stated in the order. The order of suspension would operate for a period not more than six months and may be communicated to the Agency as also to the Investigating Department. The Investigating Department may ensure that their investigation is completed and whole process of final order is over within such period.~~

~~5.2 The order of suspension shall be communicated to all Commercial Departmental Heads. During the period of suspension, no business dealing may be held with the Agency.~~

~~5.3 As far as possible, the existing contract(s) with the Agency may continue unless the Competent Authority, having regard to the circumstances of the case, decides otherwise.~~

~~5.4 If the gravity of the misconduct under investigation is very serious and it would not be in the interest of MDL, as a whole, to deal with such an Agency pending investigation, the Competent Authority may order suspension of business dealing with Agency and send his recommendation to Chief Vigilance Officer (CVO), MDL alongwith the material available, copy of which may be issued to the Agency concerned with intimation to CVO MDL. Such an order would operate for a period of six months from the date of issue.~~

~~5.5 If the Agency concerned asks for detailed reasons of suspension, the Agency may be informed that its conduct is under investigation. It is not necessary to enter into correspondence or argument with the Agency at this stage.~~

~~5.6 It is not necessary to give any show cause notice or personal hearing to the Agency before issuing the order of suspension. However, if investigations are not complete in six months' time, the Competent Authority may extend the period of suspension by another three months, during which period the investigations must be completed.~~

## **~~6. Ground on which Banning of Business Dealings can be initiated~~**

~~6.1 If the security consideration, including questions of loyalty of the Agency to the State, so warrants; Page No. 8.57 Amdt. No : 0 Date : 01/01/2015~~

~~6.2 If the Director / Owner of the Agency, proprietor or partner of the firm, is convicted by a Court of Law for offences involving moral turpitude in relation to its business dealings with the Government or any other public sector enterprises or MDL, during the last five years;~~

~~6.3 If there is strong justification for believing that the Directors, Proprietors, Partners, owner of the Agency have been guilty of malpractices such as bribery, corruption, fraud, substitution of tenders, interpolations, etc;~~

~~6.4 If the Agency continuously refuses to return / refund the dues of MDL without showing adequate reason and this is not due to any reasonable dispute which would attract proceedings in arbitration or Court of Law;~~

~~6.5 If the Agency employs a public servant dismissed / removed or employs a person convicted for an offence involving corruption or abetment of such offence;~~

~~6.6 If business dealings with the Agency have been banned/blacklisted by Government Agencies/ Statutory bodies, DGQA, Defence Shipyards, DPSUs or with whom commercial transactions have been suspended for sufficient and justifiable reasons. If the Agency having same promoters/Directors /Partners as the barred/blacklisted Company as at 6.6 above for the duration for which the barring/blacklisting of sister concern persists.~~

~~6.7 If the Agency has resorted to Corrupt, fraudulent practices including misrepresentation of facts; If the agency who had fraudulently dealt with the Company for pecuniary gains or had connived with dealing officers for mutual benefit.~~

~~6.8 If the Agency uses intimidation / threatening or brings undue outside pressure on the MDL or its official in acceptance / performances of the job under the contract;~~

~~6.9 If the Agency indulges in repeated and / or deliberate use of delay tactics in complying with contractual stipulations;~~

~~6.10 Wilful indulgence by the Agency in supplying sub-standard material irrespective of whether pre-despatch inspection was carried out by MDL or not;~~

~~6.11 Based on the findings of the investigation report of CBI / Police against the Agency for malafide / unlawful acts or improper conduct on his part in matters relating to the MDL or even otherwise;~~

~~6.12 Established litigant nature of the Agency to derive undue benefit;~~

~~6.13 Continued poor performance of the Agency in several contracts;~~

~~6.14 If the Agency misuses the premises or facilities of the MDL, forcefully occupies, tampers or damages the Company's properties including land, water resources, forests / trees, etc.~~

~~If the Agency who knowingly collude to defeat competition with the aim of deriving undeserved profit or gain from doing business with MDL.~~

~~(Note: The examples given above are only illustrative and not exhaustive. The Competent Authority may decide to ban business dealing for any good and sufficient reason).~~

### **~~7- Banning of Business Dealings~~**

~~7.1 Decision to ban business dealings with any Agency would apply throughout the Company.~~

~~7.2 There will be a Standing Committee to be appointed by the CMD which may include HOD of respective Commercial Section/Capital Works/OTS, HOD (M), rep of Legal Deptt. and OIC (SR&R) for processing the cases of "Banning of Business Dealings". The functions of the committee shall, inter-alia include:~~

~~i) To study the report of the Investigating Agency and decide if a prima facie case for banning exists, if not, send back the case to the Competent Authority.~~

~~ii) To recommend for issue of show cause notice to the Agency by the concerned department.~~

~~iii) To examine the reply to show cause notice and call the Agency for personal hearing, if required.~~

~~iv) To submit final recommendation to the Competent Authority for banning or otherwise.~~

~~7.3 If the Competent Authority is prima facie of view that action for banning business dealings with the Agency is called for, a show cause notice may be issued to the Agency as per paragraph 9.1 and an enquiry held accordingly.~~

### **~~8- Removal from List of Approved Agencies—Suppliers / Contractors, etc.~~**

~~8.1 If the Competent Authority decides that the charge against the Agency is of a minor nature, it may issue a show cause notice as to why the name of the Agency should not be removed from the list of approved Agencies—Suppliers / Contractors, etc.~~

~~8.2 The effect of such an order would be that the Agency would not be disqualified from competing in Open Tender Enquiries but LTE may not be given to the Agency concerned.~~

~~8.3 Past performance of the Agency may be taken into account while processing for approval of the Competent Authority for awarding the contract.~~

### ~~9. Show cause Notice~~

~~9.1 In case where the Competent Authority decides that action against an Agency is called for, a show cause notice has to be issued to the Agency. Statement containing the imputation of misconduct or mis-behaviour may be appended to the show cause notice and the Agency should be asked to submit within 15 days a written statement in its defence.~~

~~9.2 If the Agency requests for inspection of any relevant document in possession of MDL, necessary facility for inspection of documents may be provided.~~

~~9.3 The Competent Authority may consider and pass an appropriate speaking order:~~

- ~~a) For exonerating the Agency if the charges are not established;~~
- ~~b) For removing the Agency from the list of approved Suppliers / Contactors, etc.~~
- ~~c) For banning the business dealing with the Agency.~~

~~9.4 If it decides to ban business dealings, the period for which the ban would be operative may be mentioned. The order may also mention that the ban would extend to the interconnected Agencies of the Agency.~~

### ~~10. Appeal against the Decision of the Competent Authority~~

~~10.1 The Agency may file an appeal against the order of the Competent Authority banning business dealing, etc. The appeal shall lie to Appellate Authority. Such an appeal shall be preferred within one month from the date of receipt of the order banning business dealing, etc.~~

~~10.2 Appellate Authority would consider the appeal and pass appropriate order which shall be communicated to the Agency as well as the Competent Authority.~~

### ~~11. Review of the Decision by the Competent Authority~~

~~Any petition / application filed by the Agency concerning the review of the banning order passed originally by Competent Authority under the existing guidelines either before or after filing of appeal before the Appellate Authority or after disposal of appeal by the Appellate Authority, the review petition can be decided by the Appellate Authority upon disclosure of new facts / circumstances or subsequent development necessitating such review. The Competent Authority may refer the same petition to the separate Standing Committee which may be constituted by Appellate Authority for examination and recommendation.~~

### ~~12. Circulation of the names of Agencies with whom Business Dealings have been banned~~

~~12.1 Depending upon the gravity of misconduct established, the Competent Authority may direct HOD (Materials)/OIC (SR&R) to circulate the names of Agency with whom business dealings have been banned, to the Government Departments, other Public Sector Enterprises, etc. for such action as they deem appropriate.~~

~~12.2 If Government Departments or a Public Sector Enterprise request for more information about the Agency with whom business dealings have been banned, a copy of the report of Inquiring Authority together with a copy of the order of the Competent Authority / Appellate Authority may be supplied.~~

~~12.3 If business dealings with any Agency have been banned by the Central or State Government or any other Public Sector Enterprise, MDL may, without any further enquiry or investigation, issue an order banning business dealing with the Agency and its interconnected Agencies.~~

**FORM OF WARRANTY CERTIFICATE**

In accordance with the Order N<sup>o</sup>..... Dated ..... placed by MAZAGON DOCK SHIPBUILDERS LIMITED on \_\_\_\_\_ (Name of firm)

\_\_\_\_\_ (Name of firm) certify that the following Items identified by the following references related to Submarine No:

Description of Item(s).....

Manufacturer's Serial Number (OR any other such ID No) of the Equipment / Item.....

Delivery Challan No. / ~~Bill of Lading~~ No & Date / Air Way Bill No & Date .....

Covered by \_\_\_\_\_ (Name of firm) Invoice No & Date..... are warranted according to the terms and conditions as specified in the order.

**The Date of issue of the certificate: DD/MM/YYYY**

**The Date of the end of validity of the guarantee: DD/MM/YYYY**

For and on behalf of

|   |  |
|---|--|
| <b>Order reference Number</b>                 |  |
| <b>Description of Material</b>                |  |
| <b>Corresponding to Invoice No &amp; Date</b> |  |

-----

***(to be executed on non-judicial stamp paper of requisite value as per place of execution in India)***

## **DEED OF GUARANTEE**

**THIS DEED OF GUARANTEE ("Deed")** made and executed at (\*) on this the \_\_\_\_\_ day of \_\_\_\_\_ 20 by: (\*), a (\*) existing under the laws of (\*) and having its registered at (\*) (hereinafter referred to as "**the Principal Manufacturer"/ "Original Equipment Manufacturer(OEM)"**), which expression shall unless it be repugnant to the subject or context thereof be deemed to include their respective heirs, executors, administrators and legal representatives) being the Party of the FIRST PART;

**IN FAVOUR OF MAZAGON DOCK SHIPBUILDERS LIMITED**, a company existing under the laws of India, having its registered office at Dockyard Road, Mazagon, Mumbai 400010, India (hereinafter referred to as the **(MDL)**, which expression, unless excluded by or in contradiction to the subject or context, shall mean and include its successors and assigns) being the Party of the OTHER PART;

**Whereas:**

A. MDL has floated a Tender Bearing Tender No. (\*) dated (\*) ("**Tender**"), wherein quotations were invited for supplying of (\*) ("**Goods&/or Services**") as stipulated in the Tender at locations as specified in the Tender.

B. The Principal Manufacturer /OEM has agreed to submit its bid through an authorised representative namely (\*) (hereinafter referred to as "**Authorised Representative**"), for the aforesaid Tender.

C. The Principal Manufacturer/OEM has represented that it has authorised the Authorised Representative to act on its behalf herein for submitting the bid and to act as an intermediary for supplying the Goods &/or Services to MDL as per the terms of the Tender, as mentioned herein this Deed.

D. The Tender Condition No. (\*) requires that the Principal Manufacturer furnishes a legally enforceable document, i.e. this Deed, for the purpose of ensuring smooth execution of the Contract if awarded to the Authorised Representative (pursuant to the Tender) and for assuring that all obligations as stated in the Contract will be fulfilled therein, including warranty and guarantee obligations contained in the Tender. It is further clarified that MDL shall award the contract and sign the relevant transaction documents ("**Transaction Documents**") with the Authorised Representative (in the event of its bid qualifying as per the criteria stipulated in the Tender).

E. Thus, the Principal Manufacturer/OEM has agreed to execute this Deed in favour of MDL.

**NOW THIS INDENTURE WITNESSETH THAT IN CONSIDERATION OF THE ABOVE PREMISES IT IS HEREBY COVENANTED AND AGREED (THE PRINCIPAL MANUFACTURER /OEM COVENANTING AND AGREEING JOINTLY AND SEVERALLY) AS FOLLOWS:**

1. As per Tender condition No. (\*), the Principal Manufacturer /OEM hereby, absolutely, irrevocably and unconditionally guarantees to MDL, the performance by the Principal Manufacturer /OEM of all of the obligations in/under the said Tender and Transaction Documents whether executed by the Principal Manufacturer /OEM directly or the Authorised Representative or both, to the satisfaction of MDL in the event of failure of the Authorised Representative or otherwise upon the occurrence of an event of default under the said Tender and/or Transaction Documents.

2. Any such demand made by MDL on the Principal Manufacturer /OEM shall be final, conclusive and binding notwithstanding any contractual arrangement, difference or any dispute between Principal Manufacturer /OEM and MDL and/or MDL and the Authorised Representative or any other legal proceedings, pending before any court, tribunal, arbitrator or any other authority. The Principal Manufacturer /OEM shall be bound by the terms and conditions of the Tender and/or Transaction Documents.

3. The Principal Manufacturer /OEM shall indemnify and hold harmless MDL from any claim made against MDL or any third party for injury, damage, loss or expenses attributable to the breach /non-performance of responsibilities by the Authorised Representative.

4. In order to give effect to the Guarantee herein contained MDL shall be entitled to act as if the Principal Manufacturer /OEM was originally liable to MDL for all the obligations of the Authorised Representative as mentioned in the Tender and/or Transaction Documents.

5. Notwithstanding MDL's rights herein or under the Tender and/or Transaction Documents, MDL shall have fullest liberty to call upon the Principal Manufacturer /OEM to perform the obligation of the Authorised Representative under the Tender and/or Transaction Documents and pay together with interest as well as the costs (including reasonable attorney costs) charges and expenses, and/or other money for the time being due to MDL in respect of the aforesaid.

6. The Guarantee herein contained shall not be determined or in any way prejudiced by any absorption of or by any amalgamation thereof of MDL but shall ensure and be available for and by the absorbing or amalgamated entity.

7. The Guarantee shall be irrevocable and enforceable against the Principal Manufacturer /OEMs notwithstanding any dispute between the Principal Manufacturer /OEM and the Authorised Representative.

8. The Principal Manufacturer /OEM hereby agrees that notwithstanding any variation made in the terms of the Transaction Documents, the Principal Manufacturer /OEM shall not be released or discharged of their obligation under this Guarantee provided that in the event of such variation the liability of the Principal Manufacturer /OEM shall notwithstanding anything herein contained be deemed to have accrued and the Principal Manufacturer /OEM shall be deemed to have become liable hereunder on the date or dates on which the Authorised Representative become liable to perform its obligations which became due under the said Transaction Documents.

9. The Guarantee hereby given is independent and distinct from any security that the MDL have taken or may take in any manner whatsoever whether it is by way of a performance guarantee or security Deposit as per provisions of the Tender and Transaction Documents.

10. The Principal Manufacturer /OEM shall pay all stamp duty, other duties, Taxes, fees, penalties or other charges payable on or in connection with the execution, issue, delivery, registration of this Deed, and any document, act and registration performed pursuant hereto, if and when the same has become payable according to the Applicable Law.

11. The Principal Manufacturer /OEM declares that the information and data furnished by it to MDL and the Authorised Representative pursuant to the Tender is true and correct.

12. This Deed shall be governed by and construed in all respects with the Indian laws and the parties hereto agree that any matter or issues arising hereunder or any dispute hereunder shall be subject to the jurisdiction of the competent Courts/Tribunals of the city of Mumbai in India.

13. This Deed may be executed in 2 (two) counterparts, each of which so executed will be deemed to be an original and such counterpart together will constitute one and the same Deed.

**IN WITNESS WHEREOF** the Principal Manufacturer /OEM (abovementioned) has executed these presents the day and year first hereinabove written.

Signed, Sealed and Delivered on behalf of

**By:**  
**Name: (\*)**

**Title: (\*)**

**Witness**

**1.**  
**2.**

-----

**Undertaking for Conflict of Interest Among Bidders/ Agents**

A bidder shall not have conflict of interest with other bidders. Such conflict of interest can lead to anti-competitive practices to the detriment of MDL's interests. The bidder found to have a conflict of interest shall be disqualified. A bidder may be considered to have a conflict of interest with one or more parties in this bidding process, if:

- (i) they have controlling partner (s) in common; or
- (ii) they receive or have received any direct or indirect subsidy/ financial stake from any of them; or
- (iii) they have the same legal representative/agent for purposes of this bid; or
- (iv) they have relationship with each other, directly or through common third parties, that puts them in a position to have access to information about or influence on the bid of another Bidder; or
- (v) Bidder participates in more than one bid in this bidding process. Participation by a Bidder in more than one Bid will result in the disqualification of all bids in which the parties are involved. However, this does not limit the inclusion of the components/ sub-assembly/ Assemblies from one bidding manufacturer in more than one bid.
- (vi) In cases of agents quoting in offshore procurements, on behalf of their principal manufacturers, one agent cannot represent two manufacturers or quote on their behalf in a particular tender enquiry. One manufacturer can also authorise only one agent/dealer. There can be only one bid from the following:
  - (aa) The principal manufacturer directly or through one Indian agent on his behalf; and
  - (ab) Indian/foreign agent on behalf of only one principal.
- (vii) Bidder or any of its affiliates participated as a consultant in the preparation of the design or technical specifications of the contract that is the subject of the Bid;
- (viii) In case of a holding company having more than one independently manufacturing units, or more than one unit having common business ownership/management, only one unit should quote. Similar restrictions would apply to closely related sister companies. Bidders must proactively declare such sister/ common business/ management units in same/similar line of business.

**DECLARATION BY AUTHORISED SIGNATORY OF THE FIRM**

"I..... have read the above clause regarding Conflict of Interest Among Bidders/ Agents. I certify that this bidder fulfils all the requirements in this regard and does not have any conflict of interest"

**AUTHORISED SIGNATURE:** \_\_\_\_\_

**DATE:** \_\_\_\_\_

**Seal / Stamp of Bidder**

-----

## APPENDIX - 21

## RTGS/NEFT – MANDATE AUTHORIZATION FORM

(ILLUSTRATIVE FORMAT)

1. Supplier's / Vendor's Name:

|  |  |  |  |  |  |  |  |  |  |  |  |  |  |  |  |  |  |  |  |
|--|--|--|--|--|--|--|--|--|--|--|--|--|--|--|--|--|--|--|--|
|  |  |  |  |  |  |  |  |  |  |  |  |  |  |  |  |  |  |  |  |
|--|--|--|--|--|--|--|--|--|--|--|--|--|--|--|--|--|--|--|--|

2. Supplier's / Vendor's Name as per Bank Records:

|  |  |  |  |  |  |  |  |  |  |  |  |  |  |  |  |  |  |  |  |
|--|--|--|--|--|--|--|--|--|--|--|--|--|--|--|--|--|--|--|--|
|  |  |  |  |  |  |  |  |  |  |  |  |  |  |  |  |  |  |  |  |
|--|--|--|--|--|--|--|--|--|--|--|--|--|--|--|--|--|--|--|--|

3A. Supplier's Code

|  |  |  |  |  |  |
|--|--|--|--|--|--|
|  |  |  |  |  |  |
|--|--|--|--|--|--|

3B. Supplier's PAN Number: #

|  |  |  |  |  |  |  |  |  |  |  |  |  |  |
|--|--|--|--|--|--|--|--|--|--|--|--|--|--|
|  |  |  |  |  |  |  |  |  |  |  |  |  |  |
|--|--|--|--|--|--|--|--|--|--|--|--|--|--|

# Quoting PAN No. in all the e-returns has become 100% mandatory w.e.f. 14-02-2008 hence, ensure to fill up this and also send a photocopy of PAN duly self-attested. If there is any difference between the name given in the supplier's name and name given in the PAN card, then a note to explain the reason for the difference and the correlation between both.

4. Supplier's / Vendor's Complete Postal Address:

|           |  |  |  |  |  |  |           |  |  |  |  |     |  |  |  |  |  |  |  |
|-----------|--|--|--|--|--|--|-----------|--|--|--|--|-----|--|--|--|--|--|--|--|
| Door No.  |  |  |  |  |  |  | Street:   |  |  |  |  |     |  |  |  |  |  |  |  |
| Location: |  |  |  |  |  |  | District: |  |  |  |  |     |  |  |  |  |  |  |  |
| City:     |  |  |  |  |  |  | State     |  |  |  |  | PIN |  |  |  |  |  |  |  |

5. Supplier's / Vendor's E-mail ID:

|  |  |  |  |  |  |  |  |  |  |  |  |  |  |  |  |  |  |  |  |
|--|--|--|--|--|--|--|--|--|--|--|--|--|--|--|--|--|--|--|--|
|  |  |  |  |  |  |  |  |  |  |  |  |  |  |  |  |  |  |  |  |
|--|--|--|--|--|--|--|--|--|--|--|--|--|--|--|--|--|--|--|--|

6. Supplier's / Vendor's Telephone Number &amp; Mobile Phone Number:

|  |  |  |  |  |  |  |  |  |  |  |  |  |  |  |  |  |  |  |  |
|--|--|--|--|--|--|--|--|--|--|--|--|--|--|--|--|--|--|--|--|
|  |  |  |  |  |  |  |  |  |  |  |  |  |  |  |  |  |  |  |  |
|  |  |  |  |  |  |  |  |  |  |  |  |  |  |  |  |  |  |  |  |

7. Name of the Bank:

|  |  |  |  |  |  |  |  |  |  |  |  |  |  |  |  |  |  |  |  |
|--|--|--|--|--|--|--|--|--|--|--|--|--|--|--|--|--|--|--|--|
|  |  |  |  |  |  |  |  |  |  |  |  |  |  |  |  |  |  |  |  |
|--|--|--|--|--|--|--|--|--|--|--|--|--|--|--|--|--|--|--|--|

8. Bank (Branch) Postal Address:

|  |  |  |  |  |  |  |  |  |  |  |  |  |  |  |  |  |  |  |  |
|--|--|--|--|--|--|--|--|--|--|--|--|--|--|--|--|--|--|--|--|
|  |  |  |  |  |  |  |  |  |  |  |  |  |  |  |  |  |  |  |  |
|--|--|--|--|--|--|--|--|--|--|--|--|--|--|--|--|--|--|--|--|

9. RTGS/NEFT\* - Code of the Branch:

|       |  |  |  |  |  |  |  |  |  |  |  |  |  |  |  |  |  |  |  |
|-------|--|--|--|--|--|--|--|--|--|--|--|--|--|--|--|--|--|--|--|
| RTGS: |  |  |  |  |  |  |  |  |  |  |  |  |  |  |  |  |  |  |  |
| NEFT: |  |  |  |  |  |  |  |  |  |  |  |  |  |  |  |  |  |  |  |

RTGS\* - "Real Time Gross Settlement", NEFT\* - "National Electronic Fund Transfer".

These "IFSC" Codes are unique numbers of each Branch – "Indian Financial Services Code". For some Branches both the codes are the same and some Banks, may maintain one Code No. for RTGS and another Code No. for NEFT. Hence, please fill up both the rows, even if it is the same.

10. Nature of the Account: (Tick whichever is applicable &amp; put 'x' mark for the balance two accounts)

|                      |  |                      |  |                  |  |
|----------------------|--|----------------------|--|------------------|--|
| Saving Bank Account: |  | Cash Credit Account: |  | Current Account: |  |
|----------------------|--|----------------------|--|------------------|--|

11. Bank Account Number of the Supplier: ©

|  |  |  |  |  |  |  |  |  |  |  |  |  |  |  |  |  |  |  |  |
|--|--|--|--|--|--|--|--|--|--|--|--|--|--|--|--|--|--|--|--|
|  |  |  |  |  |  |  |  |  |  |  |  |  |  |  |  |  |  |  |  |
|--|--|--|--|--|--|--|--|--|--|--|--|--|--|--|--|--|--|--|--|

© Fill up from the 1<sup>st</sup> column. For the balance left out blank columns, please mention 'x' mark.

We hereby declare that the particulars given above are correct and complete. If the transaction is delayed for reasons of incomplete or incorrect information, we would not hold MDL responsible.

Date:

Supplier's Seal:

Authorized Signature of the Supplier:

Certified that the particulars as per Serial Numbers 2, 7 to 11 are correct as per our records.

Date:

Bank's Stamp

Authorized Signature of the Officer of the

Bank.

Note: Based on the illustrative Format as above, the concerned Dealing Officer / HOD(C) may formulate / design the required forms / documents / tender enquiries / registers / GCC / proformas to suit to the requirements on case to case basis in line with the corresponding articles in Purchase Manual Volume-I.



# **Functional Specifications**



Offshore Design Section  
Engineering Services  
ISO - 9001:2008

**FUNCTIONAL  
SPECIFICATION FOR  
PIPING DESIGN**

|               |        |
|---------------|--------|
| Spec. No.     | 2004 A |
| Rev. No.      | 9      |
| Discipline    | PIPING |
| Page: 1 OF 75 |        |

**FUNCTIONAL SPECIFICATION  
FOR  
PIPING DESIGN**

*Prepared by PS 09.05.2016*  
*Reviewed by AKM 09/05/2016*  
*Approved by SJ 09/05/16*

| Prepared / Revised By | Reviewed By | Approved By | Total No. of Pages | Date     | Rev. No. |
|-----------------------|-------------|-------------|--------------------|----------|----------|
| PS                    | AKM         | SJ          | 75                 | 09.05.16 | 9        |

|   |   |   |               |        |
|---|---|---|---------------|--------|
|  | <b>Offshore Design Section</b><br><b>Engineering Services</b><br><b>ISO – 9001:2008</b> | <b>FUNCTIONAL</b><br><b>SPECIFICATION FOR</b><br><b>PIPING DESIGN</b> | Spec. No.     | 2004 A |
|   |   |   | Rev. No.      | 9      |
|   |   |   | Discipline    | PIPING |
|   |   |   | Page: 2 OF 75 |        |

**REVISION STATUS RECORD**

|                           |             |             |                       |          |          |
|---------------------------|-------------|-------------|-----------------------|----------|----------|
| PS                        | SJ          | AR          | 74                    | 04.04.14 | 8        |
| PS                        | GJ          | GRP         | 78                    | 21.07.09 | 7        |
| PS                        | GJ          | JSS         | 84                    | 07.12.06 | 6        |
| BLS                       | GJ          | JSS         | 83                    | 20.09.06 | 5        |
| BLS                       | MP          | JSS         | 83                    | 04.02.06 | 4        |
| PS                        | MP          | JSS         | 83                    | 21.06.05 | 3        |
| Prepared<br>By/Revised By | Reviewed By | Approved By | Total No.<br>of Pages | Date     | Rev. No. |

|             |                    |           |          |            |
|-------------|--------------------|-----------|----------|------------|
| FORMAT No.  | Ref. PROCEDURE No. | ISSUE No. | REV. No. | REV. DATE: |
| ODS/SOF/004 | ODS/SOP/023        | 01        | 00       | 21.07.2010 |

|   |   |   |               |        |
|---|---|---|---------------|--------|
|  | <b>Offshore Design Section<br/>Engineering Services<br/>ISO – 9001:2008</b> | <b>FUNCTIONAL<br/>SPECIFICATION FOR<br/>PIPING DESIGN</b> | Spec. No.     | 2004 A |
|   |   |   | Rev. No.      | 9      |
|   |   |   | Discipline    | PIPING |
|   |   |   | Page: 3 OF 75 |        |

## CONTENTS

### 1. INTRODUCTION

- 1.1 General
- 1.2 Purpose of this document
- 1.3 Contractor's Responsibilities

### 2. ENVIRONMENTAL DESIGN CRITERIA AND UTILITIES

- 2.1 Basic Climatic Condition
- 2.2 Seismic and Transportation Loads
- 2.3 Design Life
- 2.4 Dimensions

### 3. DESIGN REQUIREMENTS

- 3.1 General
- 3.2 Design Load Cases
- 3.3 Design Stress
- 3.4 Drawings and Calculations

### 4. MECHANICAL REQUIREMENTS

- 4.1 Minimum Thickness
- 4.2 Corrosion Allowances

### 5. MATERIALS

- 5.1 General Specification
- 5.2 Sour Service Requirement
- 5.3 Corrosion Allowance
- 5.4 Carbon Steel
- 5.5 Stain less Steel
- 5.6 Duplex Stain less Steel
- 5.7 Incoloy /Inconel Claded piping
- 5.8 Cu-Ni (90-10)
- 5.9 Copper
- 5.10 GRE
- 5.11 PVC

|             |                    |           |          |            |
|-------------|--------------------|-----------|----------|------------|
| FORMAT No.  | Ref. PROCEDURE No. | ISSUE No. | REV. No. | REV. DATE: |
| ODS/SOF/004 | ODS/SOP/023        | 01        | 00       | 21.07.2010 |

|   |   |   |               |        |
|---|---|---|---------------|--------|
|  | <b>Offshore Design Section<br/>Engineering Services<br/>ISO – 9001:2008</b> | <b>FUNCTIONAL<br/>SPECIFICATION FOR<br/>PIPING DESIGN</b> | Spec. No.     | 2004 A |
|   |   |   | Rev. No.      | 9      |
|   |   |   | Discipline    | PIPING |
|   |   |   | Page: 4 OF 75 |        |

|           |  |
|-----------|--|
| 5.12      | CPVC   |
| 5.13      | TITANIUM                                     |
| 5.14      | Material Identification                      |
| 5.15      | Supports and Miscellaneous                   |
| 5.16      | Bolting                                      |
| 5.17      | Gaskets                                      |
| 5.18      | Certification Documents                      |
| <b>6.</b> | <b>TECHNICAL NOTES FOR PIPING COMPONENTS</b> |
| 6.1       | Pipe   |
| 6.2       | Tubing                                       |
| 6.3       | Fittings                                     |
| 6.4       | Branch Connections                           |
| 6.5       | Flanges                                      |
| 6.6       | Bolting                                      |
| 6.7       | Valves                                       |
| 6.8       | Specialty Items                              |
| <b>7.</b> | <b>PIPING SYSTEM DESIGN</b>                  |
| 7.1       | General                                      |
| 7.2       | Pipe Routing                                 |
| 7.3       | Pipe Supports                                |
| 7.4       | Pipe-ways                                    |
| 7.5       | Piping Clearances                            |
| 7.6       | Flanged Connections                          |
| 7.7       | Threaded Pipe work                           |
| 7.8       | Changes in Materials                         |
| 7.9       | Vents, Drains & Bleeds                       |
| 7.10      | Corrosion Inhibition & Monitoring Pipe work  |
| 7.11      | Relief Valves                                |
| 7.12      | Control Valves                               |
| 7.13      | Isolations                                   |
| 7.14      | Fire Suppression System                      |
| 7.15      | Cupro-Nickel Pipe work                       |
| 7.16      | Copper Piping                                |

|             |                    |           |          |            |
|-------------|--------------------|-----------|----------|------------|
| FORMAT No.  | Ref. PROCEDURE No. | ISSUE No. | REV. No. | REV. DATE: |
| ODS/SOF/004 | ODS/SOP/023        | 01        | 00       | 21.07.2010 |

|   |   |   |               |        |
|---|---|---|---------------|--------|
|  | <b>Offshore Design Section<br/>Engineering Services<br/>ISO – 9001:2008</b> | <b>FUNCTIONAL<br/>SPECIFICATION FOR<br/>PIPING DESIGN</b> | Spec. No.     | 2004 A |
|   |   |   | Rev. No.      | 9      |
|   |   |   | Discipline    | PIPING |
|   |   |   | Page: 5 OF 75 |        |

|  |
|--|
| <p>7.17 GRE Piping Systems</p> <p>7.18 Piping on the Bridge</p> <p>7.19 Piping at Equipment</p> <p>7.20 Piping layout requirements</p> <p>8. PROTECTIVE COATINGS &amp; INSULATION</p> <p>9. PIPING SPECIFICATION INDEX</p> <p>10. GENERAL REQUIREMENTS</p> <p>10.1 Pre qualification criteria and tests for manufacturers (New Vendor)</p> <p>10.2 Suggested Third Party Inspection Agencies</p> <p>10.3 Quality Assurance</p> <p>10.4 Safety Provisions</p> <p>10.5 Receipt &amp; Storage</p> <p>10.6 Spares</p> <p>10.7 Warranties</p> <p>10.8 Documentation</p> <p>GLASS REINFORCED EPOXY (Annexure-1)</p> <p>1.1 Scope</p> <p>1.2 Design / Operating Data</p> <p>1.3 Design &amp; Manufacture of GRE piping</p> <p>1.4 Qualification &amp; Quality Control of GRE Piping</p> <p>1.5 Fabrication &amp; Installation of GRE Piping</p> <p>1.6 Certification Requirements of GRE Piping.</p> <p>1.7 List of Codes &amp; Standards for (GRE) Composite Material Piping</p> |
|--|

|             |                    |           |          |            |
|-------------|--------------------|-----------|----------|------------|
| FORMAT No.  | Ref. PROCEDURE No. | ISSUE No. | REV. No. | REV. DATE: |
| ODS/SOF/004 | ODS/SOP/023        | 01        | 00       | 21.07.2010 |

|   |   |   |               |        |
|---|---|---|---------------|--------|
|  | <b>Offshore Design Section<br/>Engineering Services<br/>ISO – 9001:2008</b> | <b>FUNCTIONAL<br/>SPECIFICATION FOR<br/>PIPING DESIGN</b> | Spec. No.     | 2004 A |
|   |   |   | Rev. No.      | 9      |
|   |   |   | Discipline    | PIPING |
|   |   |   | Page: 6 OF 75 |        |

## 1. INTRODUCTION

### 1.1 GENERAL

This refers to the minimum and mandatory requirements of designs & materials for piping & piping components. All piping assemblies, equipment & materials supplied or installed under these specifications shall be in accordance with sound engineering principles. Any omission from this specification shall not relieve the contractor from his responsibility of furnishing equipment or materials to meet the specific process parameters, environmental parameters, safety parameters and any other applicable statutory laws or relevant codes & standards. Substitution or changes from this specification must be accompanied with sufficient information/justification and written approval shall be obtained from the Company.

All piping, piping components, piping specialties and vessels shall be painted in accordance with Spec. No. 2005.

All piping, piping components, piping specialties and vessels shall be insulated in accordance with Spec. No. 2006.

All welding and NDT shall be performed as per Spec. 2009 F.

### 1.2 PURPOSE OF THIS DOCUMENT

This document shall form the basis upon which the Engineering Procurement and Construction Contractor can develop a detailed specification. This document should be considered as a general specification. The Contractor should update this document with the detailed design information that is developed during the detailed design phase.

### 1.3 CONTRACTOR'S RESPONSIBILITIES

The Contractor shall be responsible for the selection and design of piping, including full compliance with all applicable project specifications and design Codes / Standards, including those listed in Piping Design Criteria.

The Contractor shall provide and follow detailed pipe work specifications, covering materials, classes, fittings, valves, branches and special items. These specifications shall generally comply with this Specification.

This Specification covers all pipe work on the offshore production facilities at New platforms and for modification jobs as per the bid package and approved P&ID except the following: -

|             |                    |           |          |            |
|-------------|--------------------|-----------|----------|------------|
| FORMAT No.  | Ref. PROCEDURE No. | ISSUE No. | REV. No. | REV. DATE: |
| ODS/SOF/004 | ODS/SOP/023        | 01        | 00       | 21.07.2010 |

|   |   |   |                      |               |
|---|---|---|----------------------|---------------|
|  | <b>Offshore Design Section<br/>Engineering Services<br/>ISO – 9001:2008</b> | <b>FUNCTIONAL<br/>SPECIFICATION FOR<br/>PIPING DESIGN</b> | <b>Spec. No.</b>     | <b>2004 A</b> |
|   |   |   | <b>Rev. No.</b>      | <b>9</b>      |
|   |   |   | <b>Discipline</b>    | <b>PIPING</b> |
|   |   |   | <b>Page: 7 OF 75</b> |               |

- a. All instrument piping downstream of the last piping block valve, as defined on the P & ID's.

The Contractor shall provide the Company with all drawings, specifications and detailed pipe stress calculations for approval.

## **2. ENVIRONMENTAL DESIGN CRITERIA AND UTILITIES**

### **2.1 BASIC CLIMATIC CONDITIONS**

Refer structural design criteria, Vol-II, Section-3.4 attached in bid package.

### **2.2 SEISMIC AND TRANSPORTATION LOADS**

All equipment supports and braces, pipe supports and other support steel work, including temporary braces, shall be designed to withstand seismic loads applicable to the present location. Refer to the Structural Basis of Design for seismic design considerations.

All equipment supports and braces, pipe supports and other support steel work, including temporary braces, shall be designed to withstand the operating, lifting, transport (by road and by sea) and hydro-test loads specified in Project Specification.

### **2.3 DESIGN LIFE**

The process facilities design life requirement is 25 years.

### **2.4 DIMENSIONS**

S1 units shall be used. Dimensions shall be in mm and be related to the Platform datum's or reference lines.

## **3. DESIGN REQUIREMENTS**

### **3.1 GENERAL**

Design requirement shall be as per Cl. 4 of piping design criteria, Vol-II section 3.3.

### **3.2 DESIGN LOAD CASES**

Pipe work, its supports and anchors, shall be designed to withstand the results of the following applicable combinations of loads and forces within the limits of stress set by ASME B31.3:

- a) Hydro-test Condition (The empty weight plus weight of water to fill the piping).

|             |                    |           |          |            |
|-------------|--------------------|-----------|----------|------------|
| FORMAT No.  | Ref. PROCEDURE No. | ISSUE No. | REV. No. | REV. DATE: |
| ODS/SOF/004 | ODS/SOP/023        | 01        | 00       | 21.07.2010 |



|   |   |   |               |        |
|---|---|---|---------------|--------|
|  | <b>Offshore Design Section<br/>Engineering Services<br/>ISO – 9001:2008</b> | <b>FUNCTIONAL<br/>SPECIFICATION FOR<br/>PIPING DESIGN</b> | Spec. No.     | 2004 A |
|   |   |   | Rev. No.      | 9      |
|   |   |   | Discipline    | PIPING |
|   |   |   | Page: 8 OF 75 |        |

- b) Operating and Design Conditions (The empty weight plus the weight of operating fluid).
- c) Wind loading condition
- d) Dynamic Loading Condition
- e) Periodic Site Test Condition
- f) Any other condition that would affect the safety of the pipe work, e.g. cyclic loading and slug forces, when identified on the Data Sheet.

The pipe work shall be analyzed in its corroded state for each load combination.

### 3.3 DESIGN STRESS

Allowable stress shall be the maximum stresses permitted by ASME B31.3.

### 3.4 DRAWINGS AND CALCULATIONS

The Isometric drawings submitted by contractor shall contain information not limited to the following:

- a) Material of construction.
- b) Design pressure and design temperature.
- c) Pressure rating of piping/piping components.
- d) Hydro-test pressure.
- e) Stress relieving requirements.
- f) Stress analysis requirements.
- g) Insulation requirements.
- h) Supports details.
- i) Line number.
- j) NDT requirements.

#### Note:

In addition to above isometric drawing shall contain all pertinent information relating to the Standards, Codes and Specifications used in the design, fabrication, and inspection and testing of the pipe work, including the materials used.

The Contractor shall submit detailed calculations establishing the compliance of their design with applicable codes and standards specified in Piping Design Criteria.

|             |                    |           |          |            |
|-------------|--------------------|-----------|----------|------------|
| FORMAT No.  | Ref. PROCEDURE No. | ISSUE No. | REV. No. | REV. DATE: |
| ODS/SOF/004 | ODS/SOP/023        | 01        | 00       | 21.07.2010 |

|   |   |   |               |        |
|---|---|---|---------------|--------|
|  | <b>Offshore Design Section<br/>Engineering Services<br/>ISO – 9001:2008</b> | <b>FUNCTIONAL<br/>SPECIFICATION FOR<br/>PIPING DESIGN</b> | Spec. No.     | 2004 A |
|   |   |   | Rev. No.      | 9      |
|   |   |   | Discipline    | PIPING |
|   |   |   | Page: 9 OF 75 |        |

All calculations shall be complete, giving all references and showing all working methods. The Contractor shall be able to provide proof of software verification for any software used. Computer printouts will not be accepted without input data and complete printout.

Wherever relevant, additional calculations shall be undertaken regarding the effects of slug forces.

Contractor to prepare the piping material specification for each class & shall provide the complete information such as pipe size, thickness, fittings, flanges branch connection tables, valve selection & tag numbers, designed pressure- temperature ratings and applicable codes/standards etc. Contractor shall submit the piping class data sheets for company's approval.

Contractor to prepare the data sheets & specifications for piping specialties based on good engineering practice & applicable codes/standards and obtain company's approval.

Approval of drawings, calculations and other documents by the Company does not relieve the Contractor of their responsibility for the correctness of the design to suit the stated conditions.

#### 4. MECHANICAL REQUIREMENTS

##### 4.1 MINIMUM THICKNESS

The minimum thickness of material other than carbon steel shall be based on requirements of pressure & other mechanical loading. However, the minimum thickness of high alloy steel vessels (austenitic) & their components shall not be less than 3 mm.

Contractor to provide thickness calculations for each size & piping class. Minimum wall thickness of carbon steel & low alloy pipes, including corrosion allowance, shall be as following:

- DN 40 (1½") or less – schedule 80
- DN 50 (2") through DN 150 (6")- schedule 80
- DN 200 (8") through DN 600 (24")- standard wall.

##### 4.2 CORROSION ALLOWANCES

Unless otherwise specified on the Pipe Specification Index & other project specifications, carbon steel pipes shall have 3 mm corrosion allowance & carbon steel (NACE) shall have 6

|             |                    |           |          |            |
|-------------|--------------------|-----------|----------|------------|
| FORMAT No.  | Ref. PROCEDURE No. | ISSUE No. | REV. No. | REV. DATE: |
| ODS/SOF/004 | ODS/SOP/023        | 01        | 00       | 21.07.2010 |

|   |   |   |                |        |
|---|---|---|----------------|--------|
|  | <b>Offshore Design Section<br/>Engineering Services<br/>ISO – 9001:2008</b> | <b>FUNCTIONAL<br/>SPECIFICATION FOR<br/>PIPING DESIGN</b> | Spec. No.      | 2004 A |
|   |   |   | Rev. No.       | 9      |
|   |   |   | Discipline     | PIPING |
|   |   |   | Page: 10 OF 75 |        |

mm corrosion allowance applied to all pressure retaining parts and all surfaces of non-removable internals exposed to the process fluid.

When corrosion protection is provided by a corrosion resistant metallic lining, a minimum thickness of 3 mm of lining material shall be used.

Pipe work that is subjected to erosion e.g. due to impingement by the process stream, shall be protected with extra wall thickness.

## 5. MATERIALS

### 5.1 GENERAL SPECIFICATION

Materials shall be as per ASTM, BS or API specifications referenced in Piping Design Criteria.

Materials shall be new and unused, clean and free from rust, pits and obvious defects. Material older than one year from date of manufacturing shall not be permitted.

Cast, ductile or malleable iron, aluminum, copper, or copper-bearing alloys shall not be used in hydrocarbon service.

For carbon/carbon manganese steel vessels operating below 0°C and requiring impact testing, all pressure parts and direct attachment materials shall be manufactured with fully killed, fine grain materials.

All pipe fittings specified as galvanized shall be hot dip galvanized with a minimum of 763 grams of galvanizing material per square meter of surface area, in accordance with ASTM A123M/ASTM A153.

### 5.2 SOUR SERVICE REQUIREMENTS

#### 5.2.1 CARBON STEEL (NACE)

**This shall be in accordance with NACE Standard MR-01-75/ISO 15156-1/2/3 and shall meet the following special requirements: -**

#### **SPECIAL REQUIREMENTS FOR MANUFACTURE, INSPECTION, TESTING AND SUPPLY OF CARBON STEEL (NACE) MATERIAL:**

##### 5.2.1.1 MANUFACTURE

The following treatments during steel making are mandatory:

- a) All steel shall be fully killed and fine grained.

|             |                    |           |          |            |
|-------------|--------------------|-----------|----------|------------|
| FORMAT No.  | Ref. PROCEDURE No. | ISSUE No. | REV. No. | REV. DATE: |
| ODS/SOF/004 | ODS/SOP/023        | 01        | 00       | 21.07.2010 |

|   |   |   |                       |               |
|---|---|---|-----------------------|---------------|
|  | <b>Offshore Design Section<br/>Engineering Services<br/>ISO – 9001:2008</b> | <b>FUNCTIONAL<br/>SPECIFICATION FOR<br/>PIPING DESIGN</b> | <b>Spec. No.</b>      | <b>2004 A</b> |
|   |   |   | <b>Rev. No.</b>       | <b>9</b>      |
|   |   |   | <b>Discipline</b>     | <b>PIPING</b> |
|   |   |   | <b>Page: 11 OF 75</b> |               |

- b) All steel shall be produced using Basic oxygen or Electro Furnace Process.
- c) Steel shall be made by low sulphur and low phosphorous refining process and shall be vacuum degassed while molten by means of an approved procedure.
- d) Effective sulfide shape control by calcium treatment shall be carried out if sulphur level is in excess of 0.002% for CS-NACE plate material and piping finished product fabricated from plate material.
- e) Specific treatment to control non-metallic inclusions likes Aluminum oxide clusters, silicates and magnesium sulphide etc.

The manufacturer shall take particular care to control the rolling and heat treatment conditions so as to eliminate low temperature transformation microstructures associated with segregation such as bainite band or islets of martensite in order to reduce the propagation of HIC.

#### **5.2.1.2 INSPECTION AND TESTING**

The following tests shall be conducted in addition to relevant codes and standards. Test certificates shall be duly witnessed & certified by a Company approved third party inspection agency.

#### **A. HYDROGEN INDUCED CRACKING (HIC) TESTING**

This test shall be conducted only for pre-qualification of vendors who are not listed in suggested vendor list. This test shall be carried out on one finished product of each heat (material wise and type of construction wise, i.e. seamless and welded separately) irrespective of size/thickness. The test shall be carried out as per NACE-TM-02-84 standards.

HIC testing for casting is not required.

The test shall be performed on a set of three test specimens. The test shall be performed, as per NACE-TM-02-84 and the acceptance criteria shall be as Crack sensitivity ratio (CSR) < 1% & Crack Length Ratio (CLR) < 10.00%

In case any one of the above samples fails to meet the acceptance criteria, three more additional specimen from the product from which the first set of specimen were taken, shall be retested and results reported.

|             |                    |           |          |            |
|-------------|--------------------|-----------|----------|------------|
| FORMAT No.  | Ref. PROCEDURE No. | ISSUE No. | REV. No. | REV. DATE: |
| ODS/SOF/004 | ODS/SOP/023        | 01        | 00       | 21.07.2010 |

|   |   |   |                |        |
|---|---|---|----------------|--------|
|  | <b>Offshore Design Section<br/>Engineering Services<br/>ISO – 9001:2008</b> | <b>FUNCTIONAL<br/>SPECIFICATION FOR<br/>PIPING DESIGN</b> | Spec. No.      | 2004 A |
|   |   |   | Rev. No.       | 9      |
|   |   |   | Discipline     | PIPING |
|   |   |   | Page: 12 OF 75 |        |

In case of failure of any of the samples in above, two additional products shall be selected from the same heat and size specimens shall be tested (three from each product).

In case of failure of any one of the six-samples, the particular heat will be rejected.

#### **B. SULPHIDE STRESS CORROSION CRACKING (SSCC) TEST**

This test shall be conducted only for pre-qualification of vendors who are not listed in suggested vendor list. This test shall be carried out on one finished product of each heat (material wise and type of construction wise i.e. seamless and welded separately) irrespective of size/thickness. The test shall be carried out as per NACE-TM-01-77.

Reporting of test result: Curve shall be reported as per NACE-TM-01-77 for various stress level between 72% and 90% of SMYS.

Acceptance Criteria: At 72% SMYS, time of failure shall not be less than 720 hrs.

Sampling for test shall be same as indicated clause no. 5.2.1.2 A

#### **C. HARDNESS TEST**

This shall be carried out on finished product of each heat irrespective of size/thickness.

This test shall be carried out as per ASTM E-18/ ASTM E-92/ASTM E 10.

The product/heat for which hardness values are found in excess of specified value shall be rejected. Maximum hardness value shall be limited to HRC-22. **HB 233, HRB 99, HV 241**

#### **D. MICROSCOPIC TEST**

This shall be carried out on finished product of each heat (material wise and type of construction wise i.e. seamless and welded separately) irrespective of size/thickness.

This test shall be carried out as per ASTM E-45 Method D. Steel shall be calcium treated for inclusion morphology control & there shall not be elongated manganese sulphide inclusions.

#### **E. CHEMICAL ANALYSIS**

This shall be carried out on finished product & raw material for each heat (material wise and type of construction wise i.e. seamless and welded separately) irrespective of size/thickness. Test results shall meet the relevant codes & standards.

The acceptable level of Sulphur is as follows:

|             |                    |           |          |            |
|-------------|--------------------|-----------|----------|------------|
| FORMAT No.  | Ref. PROCEDURE No. | ISSUE No. | REV. No. | REV. DATE: |
| ODS/SOF/004 | ODS/SOP/023        | 01        | 00       | 21.07.2010 |

|   |   |   |                |        |
|---|---|---|----------------|--------|
|  | <b>Offshore Design Section<br/>Engineering Services<br/>ISO – 9001:2008</b> | <b>FUNCTIONAL<br/>SPECIFICATION FOR<br/>PIPING DESIGN</b> | Spec. No.      | 2004 A |
|   |   |   | Rev. No.       | 9      |
|   |   |   | Discipline     | PIPING |
|   |   |   | Page: 13 OF 75 |        |

- i) 0.003 % Max for Flat rolled Products
- ii) 0.01 % Max for Seamless products.
- iii) 0.025 % Max for Forging.

If the Sulphur level is higher than these limits, HIC test as per clause no. 5.2.1.2 A shall be carried out.

Carbon equivalent (CE) shall be less than 0.40 & PCM shall be less than 0.21 and shall be computed as per one of the following formulae depending upon.

- a) If  $C \geq 0.12\%$ ,  $CE = C + Mn/6 + (Cr+Mo+V)/5 + (Ni+Cu)/15$
- b) If  $C < 0.12\%$ ,  $PCM = C + Si/30 + (Mn+Cu+Cr)/20 + Ni/60 + Mo/15 + V/10 + 5B$

#### F. MECHANICAL TEST

The mechanical properties shall be as per the specified material specification.

#### F. THROUGH THICKNESS TENSION TEST (FOR PLATES)

Plates 25mm and above in thickness shall be tested perpendicular to the rolled, surface with frequency and test procedure as per ASTM A 770 and determination of reduction of area as per ASTM A370. Minimum reduction area shall not be less than 35%.

#### G. ULTRASONIC TESTING (FOR PLATES)

Test shall be performed for thickness 12.7mm and above according to ASTM A578 level – B. No repaired welding shall be permitted on plates.

#### 5.2.2 STAINLESS STEEL (NACE)

This shall be in accordance with NACE Standard MR-01-75/ ISO 15156-1/2/3 and test requirement as per applicable material standard.

#### A. INTER GRANULAR CORROSION CRACKING (IGC)

For all austenitic stainless steel Piping, Piping components and Valves, Inter-granular Corrosion Test (IGC) shall be conducted as per following ASTM A 262 practice “B” with acceptance criteria of 60 mills per year (max) for all materials- forged, rolled, wrought and casting.



#### 5.2.3 DUPLEX STAINLESS STEEL

This shall be in accordance with NACE Standard MR-01-75/ ISO 15156-1/2/3 and test requirement as per applicable material standard.

|             |                    |           |          |            |
|-------------|--------------------|-----------|----------|------------|
| FORMAT No.  | Ref. PROCEDURE No. | ISSUE No. | REV. No. | REV. DATE: |
| ODS/SOF/004 | ODS/SOP/023        | 01        | 00       | 21.07.2010 |

|   |   |   |                       |               |
|---|---|---|-----------------------|---------------|
|  | <b>Offshore Design Section<br/>Engineering Services<br/>ISO – 9001:2008</b> | <b>FUNCTIONAL<br/>SPECIFICATION FOR<br/>PIPING DESIGN</b> | <b>Spec. No.</b>      | <b>2004 A</b> |
|   |   |   | <b>Rev. No.</b>       | <b>9</b>      |
|   |   |   | <b>Discipline</b>     | <b>PIPING</b> |
|   |   |   | <b>Page: 14 OF 75</b> |               |

The following tests shall be conducted in addition to relevant codes and standards. Test certificates shall be duly witnessed & certified by a Company approved third party inspection agency.

**A. CHLORIDE STRESS CORROSION CRACKING TEST**

This test shall be conducted only for pre-qualification of vendors who are not listed in suggested vendor list.

Either of the two tests given below can be carried out to assess the chloride Stress Cracking Resistance of the Material.

**Test: 1**

This test shall be conducted on the material at 155 Deg C with aeration in 45% MgCl<sub>2</sub> solution as per ASTM G36. Stress to cause rupture in 500 hours shall exceed 0.35 times the ultimate tensile strength. This test shall be carried out on one finished product of each heat irrespective of size & thickness.

**Test: 2**

This test shall be conducted on specimen as per ASTM G 36 at 100 degree Celsius with aeration in boiling 40% CaCl<sub>2</sub> solution & pH shall be at 6.5. Stress to cause rupture in 500 hours shall exceed 0.85 times the ultimate tensile strength. This test shall be carried out on one finished product of each heat irrespective of size & thickness.

**B. PITTING CORROSION TEST**

This test shall be conducted on specimen as per **ASTM G48** using ferric chloride solution (10% FeCl<sub>3</sub>.6 H<sub>2</sub>O) as per method A at 22±2<sup>0</sup> C for 72 hours and at 50<sup>0</sup> C for 24 hours. The acceptance criteria shall be no pitting shall occur on surface of tested material for the test at 22±2<sup>0</sup> C and for the test at 50<sup>0</sup> C weight loss shall be reported to company for review. In addition to that, another test shall also be carried out to establish the critical pitting temperature as per method E of ASTM G 48 and report the critical pitting temperature to company for review. Preferably minimum critical pitting temperature shall be 30<sup>0</sup> C.

**C. INTERGRANULAR CORROSION TEST (HUEY TEST)**

The test shall be carried out, as per **ASTM A 262 Practice C**. weight loss shall not exceed 4 mils/month. This test shall be carried out on one finished product of each heat irrespective of size & thickness. The entire test reports shall be from the product specimen drawn from the heat bearing same number.

**D. CHEMICAL TEST**

This test shall be carried out on finished product of each heat irrespective of size & thickness as per relevant codes & standards with following limitation.

|             |                    |           |          |            |
|-------------|--------------------|-----------|----------|------------|
| FORMAT No.  | Ref. PROCEDURE No. | ISSUE No. | REV. No. | REV. DATE: |
| ODS/SOF/004 | ODS/SOP/023        | 01        | 00       | 21.07.2010 |

|   |   |   |                |        |
|---|---|---|----------------|--------|
|  | <b>Offshore Design Section<br/>Engineering Services<br/>ISO – 9001:2008</b> | <b>FUNCTIONAL<br/>SPECIFICATION FOR<br/>PIPING DESIGN</b> | Spec. No.      | 2004 A |
|   |   |   | Rev. No.       | 9      |
|   |   |   | Discipline     | PIPING |
|   |   |   | Page: 15 OF 75 |        |

Pitting index (P.I) shall be computed as per following formulae.

$$P.I. = \%Cr + 3.3(\% Mo) + 16(\% N_2)$$

The Pitting index of the material shall be greater than 35.

Carbon content shall be 0.03% (max.)

Sulphur content shall be 0.02%(max.)

#### **E. MICRO STRUCTURAL EXAMINATION AND FERRITE MEASUREMENT**

Ferrite content measurement of the material shall be carried out as per ASTM E 562 for each heat by metallographic examination. Ferrite content shall be in the range of 45% to 55%.

#### **F. HARDNESS TEST**

This test shall be carried out on finished product per heat, manufacturing method wise as per ASTM E 18 irrespective of size & thickness. Maximum hardness of the product shall be limited to HRC 25 (max.).

#### **G. SULPHIDE STRESS CORROSION CRACKING (SSCC) TEST**

This test shall be conducted only for pre-qualification of vendors who are not listed in suggested vendor list.

Resistance of the materials to sulphide stress corrosion cracking shall be tested using:

- a) NACE –TM- 01-77 test solution (test temp.24° C) minimum stress for cracking in 720 hrs. is 350 N/mm<sup>2</sup>.
- b) NACE-TM-01-77 test solution (test temp. 90° C and total pressure of H<sub>2</sub>S =16 bars) minimum stress for cracking in 720 hrs. is 325 N/mm<sup>2</sup>.

#### **H. MECHANICAL TEST**

The following mechanical test shall be carried out: -

##### **(I) Tensile Test**

The material in solution-annealed condition shall conform to the mechanical properties requirements specified below-

- a) Ultimate Tensile Strength : 680-900 N/mm<sup>2</sup>
- b) Yield Strength (0.2% offset) : 450 N/mm<sup>2</sup> (min)

|             |                    |           |          |            |
|-------------|--------------------|-----------|----------|------------|
| FORMAT No.  | Ref. PROCEDURE No. | ISSUE No. | REV. No. | REV. DATE: |
| ODS/SOP/004 | ODS/SOP/023        | 01        | 00       | 21.07.2010 |



|   |   |   |                |        |
|---|---|---|----------------|--------|
|  | <b>Offshore Design Section<br/>Engineering Services<br/>ISO – 9001:2008</b> | <b>FUNCTIONAL<br/>SPECIFICATION FOR<br/>PIPING DESIGN</b> | Spec. No.      | 2004 A |
|   |   |   | Rev. No.       | 9      |
|   |   |   | Discipline     | PIPING |
|   |   |   | Page: 16 OF 75 |        |

- c) Yield Strength (1.0% offset) : 500 N/mm<sup>2</sup> (min)
- d) Elongation : 25% minimum
- e) Hardness : HRC-25 (max.)

(II) Impact Test

Fracture Toughness (Charpy V-Notch Energy)

- For Wrought Materials

|                    |                                   |
|--------------------|-----------------------------------|
| At +20 °C (68 °F)  | 120 Joule (Avg)<br>90 Joule (Min) |
| At -30 °C (-22 °F) | 100 Joule (Avg)<br>75 Joule (Min) |

- For Cast Materials

|                    |                                  |
|--------------------|----------------------------------|
| At +20 °C (68 °F)  | 75 Joule (Avg)<br>55 Joule (Min) |
| At -30 °C (-22 °F) | 60 Joule (Avg)<br>40 Joule (Min) |

**I. CREVICE CORROSION**

This test shall be conducted on specimen as per **ASTM G48** using ferritic chloride solution (10% FeCl 3.6 H<sub>2</sub>O) at 25 degree Celsius for 24 hours. The acceptance criteria shall be no crevice corrosion shall occur on surface of tested material at specific temperature. This test shall be carried out on finished product of each heat irrespective of size & thickness.

**5.2.4 Incoloy 825/Inconel 625 AND Incoloy 825/ Inconel 625 CLAD CARBON STEEL PIPE MATERIALS**

This shall be in accordance with NACE Standard MR-01-75 and test requirement as per applicable material standard.

**A TECHNICAL REQUIREMENTS FOR CLAD PLATES**

- Clad plates shall be made by using standard practice suitable to obtain metallurgical bonding between carbon steel and corrosion resistant alloy. A detailed procedure for production of clad plates shall be submitted for company's approval and shall include the following as a minimum:

- Material traceability system

|             |                    |           |          |            |
|-------------|--------------------|-----------|----------|------------|
| FORMAT No.  | Ref. PROCEDURE No. | ISSUE No. | REV. No. | REV. DATE: |
| ODS/SOF/004 | ODS/SOP/023        | 01        | 00       | 21.07.2010 |

|   |   |   |                |        |
|---|---|---|----------------|--------|
|  | <b>Offshore Design Section<br/>Engineering Services<br/>ISO – 9001:2008</b> | <b>FUNCTIONAL<br/>SPECIFICATION FOR<br/>PIPING DESIGN</b> | Spec. No.      | 2004 A |
|   |   |   | Rev. No.       | 9      |
|   |   |   | Discipline     | PIPING |
|   |   |   | Page: 17 OF 75 |        |

- b) Steel and plate making process
  - c) Heating technique, rolling reductions, and working temperatures.
  - d) Cladding process
  - e) Procedure for heat treatment
  - f) Ultrasonic testing of plates and bond integrity check.
2. Each finished plate shall be subjected to automatic ultrasonic examination for checking bonding integrity and soundness of carbon steel backing plate. This test shall be carried out on 100% plate surface area on both sides, in accordance with ASTM A 578 and its supplementary requirement S3. The acceptance criteria for the finished clad plates shall be as per ASTM A 578 level B besides specific technical requirements mentioned below.
  3. Discontinuity, causing complete loss of back reflection, which cannot encompass within 75-mm diameter circles, shall be unacceptable.
  4. Clad plates having a total area of discontinuity greater than 6,000 sq. mm. shall be rejected. Also where the lamination exceeds 6.35 mm. in length measured along the two longitudinal edges of the plate, shall be rejected. A Lamina defect in the backing plate is also unacceptable. Unbounded area, which cannot be encompassed within 25-mm. diameters circles, shall be unacceptable.
  5. Acceptance criteria for integrity of bond of the cladding material shall be as per ASTM A578, level S7.
  6. No defect in corrosion resistant alloy is permitted. Minor defects, if any as mentioned in (a) and (b) below may be repaired with company's prior approval by welding and shall be subsequently tested by dye-penetrant examination. This manufacturer shall submit welding procedure for company's approval prior to undertaking such repair works.
    - a) Finished clad plates having defects lower than 500-cm<sup>2</sup> area and total defect area lower than 1.5% of the total plate surface area is only allowed to be repaired.
    - b) The plates having defects lower than 500 cm<sup>2</sup> area and total defects greater than 1.5% but lower than 3% of the total surface are may be repaired with company's prior approval.
    - c) Plates having defective area greater than 3% or single defect greater than 500 cm<sup>2</sup> shall be rejected.

|             |                    |           |          |            |
|-------------|--------------------|-----------|----------|------------|
| FORMAT No.  | Ref. PROCEDURE No. | ISSUE No. | REV. No. | REV. DATE: |
| ODS/SOF/004 | ODS/SOP/023        | 01        | 00       | 21.07.2010 |

|   |   |   |                |        |
|---|---|---|----------------|--------|
|  | <b>Offshore Design Section<br/>Engineering Services<br/>ISO – 9001:2008</b> | <b>FUNCTIONAL<br/>SPECIFICATION FOR<br/>PIPING DESIGN</b> | Spec. No.      | 2004 A |
|   |   |   | Rev. No.       | 9      |
|   |   |   | Discipline     | PIPING |
|   |   |   | Page: 18 OF 75 |        |

## B. TECHNICAL REQUIREMENTS FOR CLAD PIPES

1. A detailed procedure for manufacture of pipes from clad plates shall be submitted for company's approval and shall include the following as a minimum.

- a. Pipe making procedure
- b. Welding procedure specification including chemical composition of filler wire and flux
- c. Flux handling, Heat treatment
- d. Visual and dimensional checks
- e. Inspection and testing, chemical, mechanical, corrosion, microstructure etc.
- f. Non destructive testing etc.
- g. Hydrostatic testing
- h. Finishing treatment
- i. Marking

2. The tolerances on dimensions and weights of the finished clad pipes shall be as per API Spec. 5L with the following modifications:

Permissible tolerances on nominal wall thickness shall be as follows:

- a) On Carbon Steel backing material + 10%, -5%
- b) On Clading (Incoloy-825/Inconel-625) material + 10%, negative tolerance NIL
- c) Cumulative tolerance: The cumulative tolerance resulting from all the individual variation shall be such that the maximum radial mismatches between the inside diameter of any two-pipe cross-sections is limited to 0.5mm.

3. Pipe ends shall be beveled to suit API-5L.

## C. HEAT TREATMENT

After finish rolling for bonding, all clad plate produced shall be normalized at a temperature of 950 + 50 deg.C followed by air cooling and water quenching. This will be followed by tempering treatment at 620/650 deg.C followed by air cooling.

The detailed heat treatment procedure (including any alternatives proposed) shall be submitted for Company's approval.

|             |                    |           |          |            |
|-------------|--------------------|-----------|----------|------------|
| FORMAT No.  | Ref. PROCEDURE No. | ISSUE No. | REV. No. | REV. DATE: |
| ODS/SOF/004 | ODS/SOP/023        | 01        | 00       | 21.07.2010 |

|   |   |   |                       |               |
|---|---|---|-----------------------|---------------|
|  | <b>Offshore Design Section<br/>Engineering Services<br/>ISO – 9001:2008</b> | <b>FUNCTIONAL<br/>SPECIFICATION FOR<br/>PIPING DESIGN</b> | <b>Spec. No.</b>      | <b>2004 A</b> |
|   |   |   | <b>Rev. No.</b>       | <b>9</b>      |
|   |   |   | <b>Discipline</b>     | <b>PIPING</b> |
|   |   |   | <b>Page: 19 OF 75</b> |               |

#### **D. PHYSICAL PROPERTIES AND TESTS**

Test tabs of adequate length shall be attached to an adequate number of pipes so as to facilitate carrying out the specified mechanical and corrosion tests.

The clad pipe shall be subjected to the following tests to determine the physical properties of the finished product. The test shall be carried out on the full thickness of carbon steel, after removal of corrosion resistant alloy Incoloy-825 Inconel 625, on the finished pipe. While removing corrosion resistant alloy, care must be taken not to reduce the wall thickness of carbon steel backing metal as far as possible.

##### **1. MECHANICAL PROPERTIES**

The carbon steel backing metal shall meet the requirements of mechanical properties set forth in API spec. for Line pipe and shall in addition have fracture toughness of minimum 47 Joules (average)/38 Joules (individual), when subjected to Charpy V-notch test at 0 deg.C, in accordance with ASTM A370. Testing frequency shall be as required for guided bend test mentioned below. Orientation, location, and number of specimens per pipe shall be as per supplementary requirements SR 5 of API Spec.5L.

##### **2. WELD TENSILE TEST**

The specimen shall represent full wall thickness of carbon steel with corrosion resistant alloy removed from specimen. The ultimate tensile strength shall be higher than the minimum specified for the base material. Testing frequency shall be as required for guided bend test mentioned below.

##### **3. GUIDED BEND TESTS**

The guided bend test shall be carried out on specimens taken from the each of the two representative pipes of each lot. The lot shall be defined as a maximum of 50 pipes belonging to the same heat of carbon steel and manufactured with the same process.

##### **4. MICROSCOPIC EXAMINATION AND HARDNESS TEST**

Test specimen for microscopic examination shall be taken transverse to the longitudinal weld, from the finished pipe. The width of the specimen shall be minimum of three times the width of the weld. The specimen shall then be ground suitably and etched to reveal the microstructure. The specimen shall be visually examined using a magnification profile with smooth transition to base material. The microstructure shall also be examined at a suitable, higher magnification to ensure favorable distribution of micro-constituents. Chemical composition shall be ascertained by appropriate methods to verify that in the top 2mm of the cladding it is within the specified limits. Hardness test HV 10 according to ASTM A370 and at suitable locations as per MR 01 75/ISO 15156-2, Fig.2 (Along with hardness at Parent

|             |                    |           |          |            |
|-------------|--------------------|-----------|----------|------------|
| FORMAT No.  | Ref. PROCEDURE No. | ISSUE No. | REV. No. | REV. DATE: |
| ODS/SOF/004 | ODS/SOP/023        | 01        | 00       | 21.07.2010 |

|   |   |   |                       |               |
|---|---|---|-----------------------|---------------|
|  | <b>Offshore Design Section<br/>Engineering Services<br/>ISO – 9001:2008</b> | <b>FUNCTIONAL<br/>SPECIFICATION FOR<br/>PIPING DESIGN</b> | <b>Spec. No.</b>      | <b>2004 A</b> |
|   |   |   | <b>Rev. No.</b>       | <b>9</b>      |
|   |   |   | <b>Discipline</b>     | <b>PIPING</b> |
|   |   |   | <b>Page: 20 OF 75</b> |               |

material, weld metal and HAZ of Cladded layer) shall be carried out on the test pieces already submitted to micro structural examination. In the heat affected zone indentations shall start as close to the fusion line as possible. The maximum Vickers hardness value for each single point shall not exceed 248 HV 10 on carbon steel portion and 285 HV 10 corrosion resistant alloys.

#### **E. BOND EFFICIENCY TEST**

##### **1. SHEAR TEST**

Shear test shall be performed according to ASTM A265 and minimum shear strength in the longitudinal direction shall be 140 Mpa.

##### **2. DUCTILITY TESTS**

Ductility test in longitudinal direction shall be performed according to ASTM A 265. No crack and no unbounding shall be allowed.

##### **3. CHARPY IMPACT TEST**

This test shall be performed in accordance with ASTM A 370. From each finished pipe per lot representing same heat of carbon steel and manufactured with the same process, five samples shall be taken transverse to the principal rolling direction. From each sample three specimens shall be machined. The specimens shall be notched as follows: -

- Weld Metal
- Fusion line + 2MM
- Base metal

At the test temperature of 0<sup>0</sup>.C, the fracture toughness values obtained shall be consistent with those indicated in clause C-1 above.

#### **F. CORROSION TESTS**

The specimen shall be machined only to remove the carbon steel portion and shall contain the full weld on the corrosion resistant alloy in as welded condition. Corrosion resistant alloy shall not be ground or pickled and surface of specimen shall approximate the same roughness as the finished pipe. Specimen shall be machined transverse to the weld with following dimensions:-

|                                |   |               |
|--------------------------------|---|---------------|
| Width (transverse to the weld) | : | 50 mm         |
| Length (parallel to the weld)  | : | 25 mm         |
| Thickness                      | : | 1.5 mm (Min.) |

|             |                    |           |          |            |
|-------------|--------------------|-----------|----------|------------|
| FORMAT No.  | Ref. PROCEDURE No. | ISSUE No. | REV. No. | REV. DATE: |
| ODS/SOF/004 | ODS/SOP/023        | 01        | 00       | 21.07.2010 |

|   |   |   |                |        |
|---|---|---|----------------|--------|
|  | <b>Offshore Design Section<br/>Engineering Services<br/>ISO – 9001:2008</b> | <b>FUNCTIONAL<br/>SPECIFICATION FOR<br/>PIPING DESIGN</b> | Spec. No.      | 2004 A |
|   |   |   | Rev. No.       | 9      |
|   |   |   | Discipline     | PIPING |
|   |   |   | Page: 21 OF 75 |        |

The following corrosion tests shall be carried out on the specimens prepared as above.

### 1. INTERGRANULAR CORROSION TEST

- (a) For Incoloy 825, this test shall be carried out in accordance with ASTM A-262 practice C. Maximum permitted weight loss shall not exceed 0.0040 inch/month.
- (b) For Inconel 625, this test shall be carried out in accordance with ASTM G28 Method A. Maximum permitted weight loss shall not exceed 0.0040 inch/month

### 2. PITTING CORROSION TEST

This test shall be conducted on specimen as per ASTM G48 using ferric chloride solution (10% FeCl<sub>3</sub>.6 H<sub>2</sub>O) as per method A at 22±2<sup>0</sup> C for 72 hours and at 50<sup>0</sup> C for 24 hours. The acceptance criteria shall be no pitting shall occur on internal pipe surface of tested material for the test at 22±2<sup>0</sup> C and for the test at 50<sup>0</sup> C weight loss shall be reported to company for review. In addition to that, another test shall also be carried out to establish the critical pitting temperature as per method C of ASTM G 48 and report the critical pitting temperature to company for review. Preferably minimum critical pitting temperature shall be 30<sup>0</sup> C for Incoloy 825 and 85<sup>0</sup> C for Inconel 625.

### 3. SULPHIDE STRESS CORROSION CRACKING (SSCC) TEST

This test shall be conducted only for pre-qualification of new vendors who are not listed in suggested vendor list.

Sulphide Stress Corrosion cracking test shall be carried out on the cladding alloy as follows:

- a) Test as per NACE-TM-01-77 at test temperature.
  - i) Room/24<sup>0</sup>C
- b) Test as per NACE-TM-01-77 except that the test solution shall have H<sub>2</sub>S partial pressure of 5bars and CO<sub>2</sub> partial pressure of 20bars and test temperature shall be:
  - i. At 90<sup>0</sup>C
  - ii) At 120<sup>0</sup>C

Note:- Test solution – 5% NaCl + 0.5% Acetic Acid

|             |                    |           |          |            |
|-------------|--------------------|-----------|----------|------------|
| FORMAT No.  | Ref. PROCEDURE No. | ISSUE No. | REV. No. | REV. DATE: |
| ODS/SOF/004 | ODS/SOP/023        | 01        | 00       | 21.07.2010 |

|   |   |   |                       |               |
|---|---|---|-----------------------|---------------|
|  | <b>Offshore Design Section<br/>Engineering Services<br/>ISO – 9001:2008</b> | <b>FUNCTIONAL<br/>SPECIFICATION FOR<br/>PIPING DESIGN</b> | <b>Spec. No.</b>      | <b>2004 A</b> |
|   |   |   | <b>Rev. No.</b>       | <b>9</b>      |
|   |   |   | <b>Discipline</b>     | <b>PIPING</b> |
|   |   |   | <b>Page: 22 OF 75</b> |               |

Each test result shall be evaluated based on acceptance criteria of Minimum Stress for no cracking to occur after 720 hrs equals to 95% of SMYS of cladding material used

#### **G. HYDROSTATIC TEST**

All the finished pipes shall be subject to mill hydrostatic test pressures corresponding to 90% of the specified minimum yield strength for Carbon Steel and the test pressure shall be held for at least 30 seconds. Permanent test records (Pressure time chart) shall be maintained by the manufacturer and submitted for review of Company.

#### **H. NON-DESTRUCTIVE INSPECTION**

The following non-destructive inspection shall be performed on each pipe after hydrostatic testing. A detailed non-destructive testing specification shall be developed and submitted to Company for qualification and approval.

##### **1. RADIOGRAPHIC EXAMINATION**

After hydrostatic test, the weld seams shall be checked for detection of longitudinal and transverse defects to the weld by radiographic method on the full length of the pipe. Acceptance criteria for the radiographs shall be as per ASME BPV-VIII, Division I, clause UW 51.

The film used for radiographic inspection of pipe welds shall be class 1 and 2 referring to Table –II of ASTM E-94, with film density of 1.8-3.8 that allow the sensitivity of at least 1.5% of the nominal total thickness of pipe weld bead.

##### **2. SOUNDNESS OF BONDING**

After hydrostatic test, each pipe shall be inspected by ultrasonic method for the detection of lamination and for bonding check on a circumferential band of 50mm along each side of the longitudinal weld.

No lamination and unbonding are allowed on pipes. Pipe ends of each pipe shall also be inspected by Ultrasonic examination with angle probe to detect hair line crack defects on pipe body, perpendicular to the surface, for a length at least 50 MM. No defect shall be allowed.

##### **3. MAGNETIC PARTICLE EXAMINATION**

After hydrostatic testing, all pipes shall be subject to Magnetic particle examination. This shall include full length of external surface of the weld bead of backing material to be examined by Magnetic particle method. The test procedure shall be in accordance with

|             |                    |           |          |            |
|-------------|--------------------|-----------|----------|------------|
| FORMAT No.  | Ref. PROCEDURE No. | ISSUE No. | REV. No. | REV. DATE: |
| ODS/SOF/004 | ODS/SOP/023        | 01        | 00       | 21.07.2010 |



ASTM E 709 and acceptance criteria shall be according to ASME Sec. VIII, Div.2 Part 7 Clause no. 7.5.6.2.

### 5.3 CORROSION ALLOWANCE

The corrosion allowance for various service of piping systems are shown below. MOC shall be as indicated in the P & ID.

(Wherever more than one material is indicated against the same service, the MOC shall be as per the class and grade indicated in the P&ID.)

| SERVICE  | Min CA (mm) | PIPES                        | FITTINGS        | FLANGES         |
|--|-------------|------------------------------|-----------------|-----------------|
| Hydrocarbon (Sour service) for<br>a) Gas Lift<br>b) Well Fluid | 6.0         | CS (NACE)                    | CS (NACE)       | CS (NACE)       |
|  | 1.5         | SS316L (NACE)                | SS316L (NACE)   | SS316L (NACE)   |
|  | 0.0         | DSS                          | DSS             | DSS             |
|  | 0.0         | CS with INCOLOY              | CS with INCOLOY | CS with INCOLOY |
| INJECTION WATER  | 3.0         | CS                           | CS              | CS              |
| PRODUCE WATER  | 0.0         | GRE (Glass reinforced Epoxy) | GRE             | GRE             |
| INSTRUMENT GAS   | 1.5         | SS316L (NACE)                | SS316L (NACE)   | SS316L (NACE)   |
|  | 6.0         | CS (NACE)                    | CS (NACE)       | CS (NACE)       |
| CLOSED DRAIN   | 6.0         | CS (NACE)                    | CS (NACE)       | CS (NACE)       |
| OPEN DRAIN   | 3.0         | CS                           | CS              | CS              |
|  | 0.0         | GRE                          | GRE             | CS              |
| SEA WATER  | 0.0         | 90-10Cu-Ni                   | 90-10 Cu-Ni     | 90-10Cu-Ni      |
| a)Raw Sea Water<br>• Utility Water                             |             |                              |                 |                 |



|   |   |  |                       |               |
|---|---|--|-----------------------|---------------|
|  <b>Offshore Design Section<br/>Engineering Services<br/>ISO – 9001:2008</b> | <b>FUNCTIONAL<br/>SPECIFICATION FOR<br/>PIPING DESIGN</b> |  | <b>Spec. No.</b>      | <b>2004 A</b> |
|   |   |  | <b>Rev. No.</b>       | <b>9</b>      |
|   |   |  | <b>Discipline</b>     | <b>PIPING</b> |
|   |   |  | <b>Page: 24 OF 75</b> |               |

|   |     |              |          |           |
|---|-----|--------------|----------|-----------|
| <ul style="list-style-type: none"> <li>• Cooling Water</li> <li>• Fire water</li> </ul> | 0.0 | GRE          | GRE      | Al-Bronze |
| b) Treated Sea Water  | 0.0 | GRE          | GRE      | CS        |
| <ul style="list-style-type: none"> <li>• Fire water</li> </ul>                          | 3.0 | CS           | CS       | CS        |
| INSTRUMENT AIR  | 1.5 | CS(G)        | CS(G)    | CS(G)     |
| CHEMICAL  | 0.0 | SS316L       | SS316L   | SS316L    |
| FERRITIC<br>CHLORIDE<br>CHEMICALS   | 0.5 | TITANI<br>UM | TITANIUM | TITANIUM  |
| Potable Water<br>(Drinking)   | 0.0 | Cu           | Cu       | BRONZE    |
|   | 0.0 | GRE          | GRE      | BRONZE    |
| Sodium<br>Hypo chlorite   | 0.0 | CPVC         | CPVC     | CPVC      |
| SEWAGE  | 0.0 | GRE          | GRE      | GRE       |
| ACIDISATION   | 3.0 | CS           | CS       | CS        |

**ABBREVIATIONS:**

|         |  |
|---------|--|
| AL-NI - | ALUMINIUM NICKEL                               |
| CA -    | CORROSION ALLOWANCE                            |
| CPVC -  | CHLORINATED POLYVINYL CHLORIDE                 |
| CS -    | CARBON STEEL                                   |
| CS(G) - | CARBON STEEL (GALVANISED)                      |
| DSS -   | DUPLEX STAINLESS STEEL                         |
| GRE -   | GLASS REINFORCED EPOXY                         |
| MM -    | MILIMETER                                      |
| NACE -  | NATIONAL ASSOCIATION OF CORROSION<br>ENGINEERS |
| PVC -   | POLYVINYL CHLORIDE                             |
| SS -    | STAINLESS STEEL                                |

|             |                    |           |          |            |
|-------------|--------------------|-----------|----------|------------|
| FORMAT No.  | Ref. PROCEDURE No. | ISSUE No. | REV. No. | REV. DATE: |
| ODS/SOF/004 | ODS/SOP/023        | 01        | 00       | 21.07.2010 |

|   |   |   |                       |               |
|---|---|---|-----------------------|---------------|
|  | <b>Offshore Design Section<br/>Engineering Services<br/>ISO – 9001:2008</b> | <b>FUNCTIONAL<br/>SPECIFICATION FOR<br/>PIPING DESIGN</b> | <b>Spec. No.</b>      | <b>2004 A</b> |
|   |   |   | <b>Rev. No.</b>       | <b>9</b>      |
|   |   |   | <b>Discipline</b>     | <b>PIPING</b> |
|   |   |   | <b>Page: 25 OF 75</b> |               |

## 5.4 CARBON STEEL

### 5.4.1 CARBON STEEL (NON-NACE)

Carbon Steel materials used and specified as per American specifications. Bolting shall be ASTM A193 Grade B7/194 Grade 2H and it shall be Hot dip galvanized as per ASTM 153.

#### PIPES:

ASTM A 106 Gr. B (seamless), API 5L Gr. B (seamless / SAW),  
API 5 L Gr. X 52 (Seamless/SAW), API 5L Gr. X 60 (Seamless / SAW), ASTM 333 Gr.6 (Seamless)

#### FITTINGS:

|                     |                     |
|---------------------|---------------------|
| ASTM A 234 Gr. WPB, | ASTM-A105,          |
| MSS SP Gr. WPHY 52  | MSS SP Gr. WPHY 60  |
| ASTM A 350 Gr. LF2  | ASTM A 420 Gr. WPL6 |

#### FLANGES:

|                    |                    |
|--------------------|--------------------|
| ASTM A105,         | ASTM A694 Gr. F52, |
| API 6A Type 2,     | API6A Type 4       |
| ASTM A 350 Gr. LF2 |                    |

#### VALVES:

BODY- ASTM 216 GR WCB, ASTM A 105, ASTM A 350 Gr. LF2, ASTM A 352 Gr. LCC  
TRIM- 11-13% CROME (MIN.)/ ASTM 182 GRADE F316

**PLATE** : ASTM A-516 Grade 70

### 5.4.2 CARBON STEEL (NACE)

Material shall be same as clause no. 5.4.1. Sour service requirement shall be in compliance with clause no. 5.2.1 of this document.

**STUD BOLTS:** ASTM A-193 Grade B7M, For Low temperature use ASTM A 320 Gr. L7,(22 HRC max. hardness)

**NUTS:** ASTM A-194 Grade 2HM, For low temperature use ASTM 194 Gr.4 (22 HRC max. hardness)

Stress relieving of rolled plates, formed heads and pipe fittings shall be in accordance with NACE Standard MR0175.

|             |                    |           |          |            |
|-------------|--------------------|-----------|----------|------------|
| FORMAT No.  | Ref. PROCEDURE No. | ISSUE No. | REV. No. | REV. DATE: |
| ODS/SOF/004 | ODS/SOP/023        | 01        | 00       | 21.07.2010 |

|   |   |   |                |        |
|---|---|---|----------------|--------|
|  | <b>Offshore Design Section<br/>Engineering Services<br/>ISO – 9001:2008</b> | <b>FUNCTIONAL<br/>SPECIFICATION FOR<br/>PIPING DESIGN</b> | Spec. No.      | 2004 A |
|   |   |   | Rev. No.       | 9      |
|   |   |   | Discipline     | PIPING |
|   |   |   | Page: 26 OF 75 |        |

## 5.5 STAINLESS STEEL

### 5.5.1 STAINLESS STEEL (Non-NACE)

Stainless steel materials are suitable for inner/wet parts of valves, instrumentation & vessels. Only following American specifications as specified against each product are permitted. MOC of stud bolt and nut shall be same as that of CS NON-NACE (cl. 5.4.1). Necessary considerations shall be followed to avoid galvanic corrosion.

PIPES : ASTM A 312 Gr. TP 316  
ASTM A 358 TP 316

FITTING : ASTM A 403 Gr. WP 316  
ASTM A 182 Gr. F316

FLANGES : A 182 Gr. F 316

VALVES :

BODY : ASTM A 182 GRADE F 316 / ASTM A 351 GR CF8M SS316

TRIM : ASTM A 182 GRADE F 316 / SS 316

stainless steel (grade B8) vs. carbon steel (grade B7 & B16)  
ASTM A193 Grade B7M studs are identical in chemistry to Grade B7, as they are quenched and tempered carbon steel to achieve a lower hardness. However, they have a lower tensile strength than B7 studs. We typically see Grade B7M bolts in hydrogen stress corrosion cracking (SCC) applications such as hydrofluoric acid or in Floating Head Heat Exchangers. ASTM A194 GRADE 2HM are similar to 2H nuts, except this grade is recommended for use in stress corrosion cracking environments.

#### Note:

For all austenitic stainless steel Piping, Piping components and Valves, Inter-granular Corrosion Test (IGC) shall be conducted as per following ASTM A 262 practice “B” with acceptance criteria of 60 mills per year (max) for all materials- forged, rolled, wrought and casting.

Or

ASTM A 262 practice “E” with acceptance criteria of “No cracks as observed from 20X Magnifications” for all materials other than castings “Microscopic structure to be observed from 250-X magnification” in addition.

### 5.5.2 STAINLESS STEEL (NACE)

Sour service requirement shall be in compliance with clause no. 5.2.2 of this document. MOC of stud bolt and nut shall be same as that of CS NACE (cl. 5.4.2).

PIPES : ASTM A 312 Gr. TP 316 L  
ASTM A 358 TP 316 L

FITTING: ASTM A 403 Gr. WP 316 L  
ASTM A 182 Gr. F316L

|             |                    |           |          |            |
|-------------|--------------------|-----------|----------|------------|
| FORMAT No.  | Ref. PROCEDURE No. | ISSUE No. | REV. No. | REV. DATE: |
| ODS/SOF/004 | ODS/SOP/023        | 01        | 00       | 21.07.2010 |

|   |   |   |                |        |
|---|---|---|----------------|--------|
|  | <b>Offshore Design Section<br/>Engineering Services<br/>ISO – 9001:2008</b> | <b>FUNCTIONAL<br/>SPECIFICATION FOR<br/>PIPING DESIGN</b> | Spec. No.      | 2004 A |
|   |   |   | Rev. No.       | 9      |
|   |   |   | Discipline     | PIPING |
|   |   |   | Page: 27 OF 75 |        |

FLANGES: A 182 Gr. F 316 L

VALVES: BODY : ASTM A 182 GRADE F 316L / ASTM-A-351 GR CF8M SS316L  
TRIM : ASTM A 182 GRADE F 316L / SS 316L

### 5.6 DUPLEX STAINLESS STEEL MATERIAL

Two grades are indicated in this MOC. However, MOC shall be as per the class and grade indicated in the P&ID.

PIPES : a) ASTM A790 UNS S 32205  
b) ASTM A790 UNS S 31803

**Note:**

On case to case basis for higher thickness if manufacturing of seam less pipe is not possible, ASTM A 928 Class1 & 3 may be used.

FITTINGS: a) ASTM A790 UNS S 32205,  
ASTM A182 Gr. F60 UNS S 32205,  
ASTM A815 Gr. WP-S/WX UNS S 32205

b) ASTM A790 UNS S 31803,  
ASTM A182 Gr. F51 UNS S 31803,  
ASTM A815 Gr. WP-S/WX UNS S 31803

FLANGES: a) ASTM A182 Gr. F60 UNS S 32205  
b) ASTM A182 F51 UNS S 31803

BOLTING: ASTM A 453 GR 660 Class A

GASKETS: Duplex stainless steel spiral wound with CNAF, Octagonal ring duplex stainless steel UNS S 32205/ UNS S 31803; Maximum hardness 22HRC.

VALVES: BODY-DSS, TRIM –DSS

**NOTES:**

- Maximum hardness shall be limited to 25 HRC. Material shall meet the requirement of NACE MR 01-75 along with additional requirements

|             |                    |           |          |            |
|-------------|--------------------|-----------|----------|------------|
| FORMAT No.  | Ref. PROCEDURE No. | ISSUE No. | REV. No. | REV. DATE: |
| ODS/SOF/004 | ODS/SOP/023        | 01        | 00       | 21.07.2010 |

|   |   |   |                |        |
|---|---|---|----------------|--------|
|  | <b>Offshore Design Section<br/>Engineering Services<br/>ISO – 9001:2008</b> | <b>FUNCTIONAL<br/>SPECIFICATION FOR<br/>PIPING DESIGN</b> | Spec. No.      | 2004 A |
|   |   |   | Rev. No.       | 9      |
|   |   |   | Discipline     | PIPING |
|   |   |   | Page: 28 OF 75 |        |

indicated in clause no. 5.2.3 of this document. This specification is in addition to relevant codes & standards.

2. Maximum temp. Limit shall be limited to 121<sup>0</sup>C. For max temp greater than 121<sup>0</sup>C, company's approval shall be obtained.
3. Stub end connections are not permitted for branch connection.
4. For butt weld fittings thickness shall be same as pipe
5. DSS shall have approximately equal proportion of Austenitic & ferritic matrix phase (ferritic content: 45-55%) for DSS.

#### 5.7 (A) INCOLOY CLAD PIPING (Incoloy 825)

PIPES: ≤ 6" Seamless Pipe as per ASTM B423 (UNS N 08825) cold finished annealed.

>6" but ≤ 12" Seamless Pipe as per ASTM B423 (UNS N 08825) hot finished annealed. SMYS of hot finished annealed pipe shall as be established considering it as unlisted component of ASME B 31.3 for the temperature range based on actual evaluation after testing.

≥ 14" – API 5L Gr. B / API 5L Gr X52, Cladding Material – Incoloy 825.

FITTING: ≤ 1 ½ " Forged ASTM B564 (UNS N 08825)

2" – 12" Butt welded fitting ASTM B366 (WP NIC MC S)

≥ 14" – from clad steel with single weld seam (joint factor 1), Cladding Material Incoloy 825.

FLANGE: ≤ 12" -- ASTM B564 (UNS N 08825)

≥ 14" -- ASTM A105 with Cladding Material Incoloy 825.

BOLTING: ASTM A453 Gr. 660 Class A.

GASKET: Spiral wound duplex stainless steel with CANF,  Octagonal ring duplex stainless steel, Hardness 22HRC

VALVE: ≤ 11/2" Body Forged ASTM B 425/ASTM B 564 (UNS N08825)

Trim Incoloy -825

≥ 2" but ≤ 6" Body Incoloy 825/DSS and Trim Incoloy 825/DSS

|             |                    |           |          |            |
|-------------|--------------------|-----------|----------|------------|
| FORMAT No.  | Ref. PROCEDURE No. | ISSUE No. | REV. No. | REV. DATE: |
| ODS/SOF/004 | ODS/SOP/023        | 01        | 00       | 21.07.2010 |

|   |   |   |                       |               |
|---|---|---|-----------------------|---------------|
|  | <b>Offshore Design Section</b><br><b>Engineering Services</b><br><b>ISO – 9001:2008</b> | <b>FUNCTIONAL</b><br><b>SPECIFICATION FOR</b><br><b>PIPING DESIGN</b> | <b>Spec. No.</b>      | <b>2004 A</b> |
|   |   |   | <b>Rev. No.</b>       | <b>9</b>      |
|   |   |   | <b>Discipline</b>     | <b>PIPING</b> |
|   |   |   | <b>Page: 29 OF 75</b> |               |

≥ 8” Body = (ASTM A 105 + 3mm Weld overlay Incoloy 825)/Solid Incoloy 825/DSS and Trim Incoloy 825/DSS. (See note-4)

### 5.7 (B) INCONEL CLAD PIPING (Inconel 625)

PIPES: ≤ 12” Seamless Pipe as per ASTM B444 UNS N 06625Gr.1 annealed.  
≥ 14” – API 5L Gr. B / API 5L Gr X52, Cladding Material – Inconel 625.

FITTING: ≤ 1 ½ ” Forged ASTM B564 (UNS N 06625)  
2” – 12” Butt welded fitting ASTM B366 (WP NC MC S) UNS N 06625  
≥ 14” – from clad steel with single weld seam (joint factor 1), Cladding Material Inconel 625.

FLANGE: ≤ 12” -- ASTM B564 (UNS N 06625)  
≥ 14” -- ASTM A105 with Cladding Material Inconel 625.

BOLTING: ASTM A453 Gr. 660 Class A.

GASKET: Spiral wound duplex stainless steel with CANF, Octagonal ring duplex stainless steel, Hardness 22HRC

VALVE: ≤ 11/2” Body Forged ASTM B 446 UNS N 06625  
Trim Inconel -625  
≥ 2” but ≤ 6” Body Inconel 625/DSS and Trim Inconel 625/DSS  
≥ 8” Body = (ASTM A 105 + 3mm Weld overlay Inconel 625) /Solid Inconel 625/DSS and Trim Inconel 625/DSS. (See note-4)

#### NOTES:

1. The corrosion resistant alloy shall meet the requirements of ASTM B424, UNS No N 08825 or ASTM B 443, UNS N 06625 as applicable with the following additional stipulated requirements:

(i) **For Incoloy 825**

- a) Max carbon content shall be 0.025%
- b) Minimum pitting index shall be 32.  
Pitting index = (% Cr + 3.3%Mo)
- c) The minimum cladding thickness shall be 3mm.
- d) Hardness shall be as per NACE MR-01-75/ISO-15156-3.

(ii) **For Inconel 625**

- a) Max carbon content shall be 0.05%

|             |                    |           |          |            |
|-------------|--------------------|-----------|----------|------------|
| FORMAT No.  | Ref. PROCEDURE No. | ISSUE No. | REV. No. | REV. DATE: |
| ODS/SOF/004 | ODS/SOP/023        | 01        | 00       | 21.07.2010 |

|   |   |   |                |        |
|---|---|---|----------------|--------|
|  | <b>Offshore Design Section<br/>Engineering Services<br/>ISO – 9001:2008</b> | <b>FUNCTIONAL<br/>SPECIFICATION FOR<br/>PIPING DESIGN</b> | Spec. No.      | 2004 A |
|   |   |   | Rev. No.       | 9      |
|   |   |   | Discipline     | PIPING |
|   |   |   | Page: 30 OF 75 |        |

- b) Minimum pitting index shall be 52.  
Pitting index = (% Cr + 3.3%Mo)
- c) The minimum cladding thickness shall be 3mm.
- d) Hardness shall be as per NACE MR-01-75/ISO-15156-3.

2. This shall be in accordance with NACE Standard MR-01-75 and test requirement as per applicable material standard along with requirements indicated below for solid Incoloy/Inconell:
  - (a) Mechanical Properties Test.
  - (b) Hardness Test.
  - (c) Chemical Properties.
  - (d) Corrosion Test as per clause No. 5.2.4, (F), (1) & (2) shall be carried out on each heat and test indicated in clause no. 5.2.4(F), (3) shall be carried out only for qualification of vendor not listed in suggested vendor list of ONGC.
3. For thickness of clad pipe and piping items only base material shall be considered.
4. MOC of valve shall be decided based on service.

### 5.8 CUPRO-NICKEL (90-10)

Cupro-nickel materials are suitable for firewater, seawater & salt-water services. Only following American/British specifications as specified against each product are permitted. Bolting shall be ASTM A193 Grade B7/194 Grade 2H and it shall be Hot dip galvanized as per ASTM 153.

PIPES: ASTM B 466 Copper alloy no. C-70600 or BS 2871 CN 102

FLANGE: EEMUA 145

FITTINGS: 90-10 Cu-Ni

VALVES Body - 5% Ni-AL BRONZE (BS 1400 AB2C), ASTM B 148 C 95800  
Trim - MONEL K 500 for sizes up to and including 6" and K400/K500 above 6"

#### **NOTES:**

- a) 90-10 Cu-Ni piping material thickness EEMUA PUB 144 to be decided based on 16-bar system
- b) Blind flanges shall be A 105 with 3 mm 90-10 Cu-Ni overlays.
- c) For composite flanges the outer flange shall be ASTM A105 (galvanized) to #150 of ASME B-16.5 up to 24" and ASME B 16.47 A for 22" and 28" &

|             |                    |           |          |            |
|-------------|--------------------|-----------|----------|------------|
| FORMAT No.  | Ref. PROCEDURE No. | ISSUE No. | REV. No. | REV. DATE: |
| ODS/SOF/004 | ODS/SOP/023        | 01        | 00       | 21.07.2010 |

|   |   |   |                |        |
|---|---|---|----------------|--------|
|  | <b>Offshore Design Section<br/>Engineering Services<br/>ISO – 9001:2008</b> | <b>FUNCTIONAL<br/>SPECIFICATION FOR<br/>PIPING DESIGN</b> | Spec. No.      | 2004 A |
|   |   |   | Rev. No.       | 9      |
|   |   |   | Discipline     | PIPING |
|   |   |   | Page: 31 OF 75 |        |

Slip On

inner flange shall be 90/10 CU-NI forged for < 2” S.O, 3” to 24” W.N.( For 3” to 24’ S.O. Bossed flanges ( suitable for welding)  
F F material Cu Ni forged (When used with flanged valve use full faced gasket and S.O. Bossed flange).

- d) Stud bolts shall be supplied with insulating sleeves and washers.

### 5.9 COPPER

Copper materials are suitable for potable water (drinking water) services. Only following American/British specifications as specified against each product are permitted. Bolting shall be ASTM A193 Grade B7/194 Grade 2H and it shall be Hot dip galvanized as per ASTM 153/ ASTM 123.

PIPES: Seam less hard drawn H-80/H55 regular Copper to ASTM B 42(UNS NO. C12200)

FLANGES: ISO 7005-3: ASTM B 61(Leaded tin Bronze)

FITTINGS: For less than or equal to 2” ASTM B 124 (UNS C 11000),  
For 3 to 4” ASTM B42 (UNS NO C 12200)

VALVES: BODY, BONNET, TRIM – ASTM B 61(Leaded tin Bronze)  
Stem, Wedge disc, Body seat ring - Forged Brass as per ASTM B 124 UNS NO. C37700 (No casting)

### NOTES:

- a) Stud bolts to be supplied with insulating sleeves & washers.
- b) Blind flanges for Cu. piping shall be ASTM A105 with 3 mm copper overlays
- c) Composite flange: Outer Flange : ASTM A 105 (Galvanized)  
Inner Flange : ASTM B 124 (UNS NO. C 11000)  
≤ 2” S.O.  
≥ 3 to 4” W.N  
For S.O. and W.N. Flange FF valves shall be used for size 2 to 4” only. FF solid slip on class 150 flange to ISO-7005-3: ASTM B 61 shall be used.
- d) Threading on pipes is not allowed. Screwed are only for vents and drains.

|             |                    |           |          |            |
|-------------|--------------------|-----------|----------|------------|
| FORMAT No.  | Ref. PROCEDURE No. | ISSUE No. | REV. No. | REV. DATE: |
| ODS/SOF/004 | ODS/SOP/023        | 01        | 00       | 21.07.2010 |



|   |   |   |                |        |
|---|---|---|----------------|--------|
|  | <b>Offshore Design Section</b><br><b>Engineering Services</b><br><b>ISO – 9001:2008</b> | <b>FUNCTIONAL</b><br><b>SPECIFICATION FOR</b><br><b>PIPING DESIGN</b> | Spec. No.      | 2004 A |
|   |   |   | Rev. No.       | 9      |
|   |   |   | Discipline     | PIPING |
|   |   |   | Page: 32 OF 75 |        |

### 5.10 GLASS REINFORCED EPOXY

Refer Annexure- 1

Note: Valve material for GRE piping shall be suitable to services for which GRE piping is used.

### 5.11 POLY VINYL CHLORIDE

PVC materials are suitable for sewage water & chemical services. Only following American specifications as specified against each product are permitted:

|          |   |   |
|----------|---|---|
| PIPES    | : | ASTM D 1785   |
| FLANGES  | : | ASTM D 2466/ASTM D 2467   |
| FITTINGS | : | ASTM D 2466/ASTM D 2467   |
| VALVES   | : | BODY – PVC-ASTM D 1784<br>TRIM – As per manufacturer Standards. |

#### NOTES:

- a) Complete piping system shall be enclosed in Galvanized carbon steel pipe for protection against mechanical damage. The size of cover shall be one size higher than the line size.
- b) The hydro test pressure shall be 1.5 times the design pressure.

### 5.12 CHLORINATED POLY VINYL CHLORIDE

CPVC materials are suitable for sodium hypo chloride services. Only following American specifications as specified against each product are permitted

|           |   |  |
|-----------|---|--|
| PIPES     | : | ASTM F 441   |
| FLANGES   | : | ASTM F 439 up to 3”/ ASTM F 437 for Threaded fittings.                                   |
| FITTINGS: |   | ASTM F 439 S.W up to 3”, ASTM F437 Union up to 3” /<br>ASTM F 437 for Threaded fittings. |
| VALVES    | : | Body ASTM- D-1784<br>Trim –As per manufacturer standards.                                |

#### NOTES:

- a) Complete piping system shall be enclosed in Galvanized carbon steel pipe for protection against mechanical damage. The size of cover shall be one size higher than the line size.
- b) All CPVC material shall be type IV Gr. 1 complying to ASTM-D-1784 (Class-23447-B)

23448?

|             |                    |           |          |            |
|-------------|--------------------|-----------|----------|------------|
| FORMAT No.  | Ref. PROCEDURE No. | ISSUE No. | REV. No. | REV. DATE: |
| ODS/SOF/004 | ODS/SOP/023        | 01        | 00       | 21.07.2010 |

|   |   |   |                |        |
|---|---|---|----------------|--------|
|  | <b>Offshore Design Section<br/>Engineering Services<br/>ISO – 9001:2008</b> | <b>FUNCTIONAL<br/>SPECIFICATION FOR<br/>PIPING DESIGN</b> | Spec. No.      | 2004 A |
|   |   |   | Rev. No.       | 9      |
|   |   |   | Discipline     | PIPING |
|   |   |   | Page: 33 OF 75 |        |

- c) Union shall be provided on one side of SCRD valves to facilitate its removal.
- d) Maximum test pressure for valve and fabrication assembly shall be 225 psi.

### 5.13 TITANIUM

Following American specifications as specified against each product are permitted.

- PIPES : ASTM B 861 Grade 2/ B862 Grade2
- FLANGES : ½” to 6” # 150 ANSI , Lap Joint Flange -Inner Flange ASTM B 363 Gr WPT2, Outer Flange ASTM A 105  
or  
½” to 6” #150 WN, RF to ASTM B 381Gr F2  
½” TO 6” Blind Flange ASTM B 381Gr F2
- FITTINGS : ASTM B 363 Gr WPT2 Seam less/ BW  
(Lap joint stub end with Neo prene insulating ring)
- VALVES : Body/Trim: ASTM B 381Gr F2/ASTM B 367Gr C2

### 5.14 MATERIAL IDENTIFICATION

All piping materials (pipe, fittings, flanges, valves, piping specialties etc., shall be supplied with mill certified test reports and certificates to identify the type of steel, composition, heat number and any special testing.

The Contractor shall furnish to the Company with one (1) copy of all mill certificates for all the materials purchased by the Contractor duly certified by company approved third party inspection agency.

The contractor shall mark with double blue stripes for NACE materials.

### 5.15 SUPPORTS AND MISCELLANEOUS

Any material shall not be welded directly on process piping. If situation arises then prior approval of Company shall be sought during detail Engineering & shall note that the material welded directly to pressure retaining pipe work shall be of similar quality as the pipe work, including impact requirements, if any, for a length measured from the vessel wall of at least 150 mm. The material of such items beyond this point may be structural

|             |                    |           |          |            |
|-------------|--------------------|-----------|----------|------------|
| FORMAT No.  | Ref. PROCEDURE No. | ISSUE No. | REV. No. | REV. DATE: |
| ODS/SOF/004 | ODS/SOP/023        | 01        | 00       | 21.07.2010 |

|   |   |   |                       |               |
|---|---|---|-----------------------|---------------|
|  | <b>Offshore Design Section<br/>Engineering Services<br/>ISO – 9001:2008</b> | <b>FUNCTIONAL<br/>SPECIFICATION FOR<br/>PIPING DESIGN</b> | <b>Spec. No.</b>      | <b>2004 A</b> |
|   |   |   | <b>Rev. No.</b>       | <b>9</b>      |
|   |   |   | <b>Discipline</b>     | <b>PIPING</b> |
|   |   |   | <b>Page: 34 OF 75</b> |               |

quality A283 Gr. C. or equal/superior (contractor to substantiate with sufficient information & documentary evidence).

#### **5.16 BOLTING**

For carbon steel and stainless steel flanged piping systems, stud bolts shall comply with ASTM A193-B7 and ASME B1.1. Nuts shall be heavy hexagon semi-finished per ASTM A194-2H and ASME B18.2.2. Carbon steel studs and nuts shall be hot dip spun galvanized in accordance with ASTM A153.

For carbon steel (NACE) flanged piping systems, stud bolts shall comply with ASTM A193-B7M and ASME B1.1. Nuts shall be heavy hexagon semi-finished per ASTM A194-2HM and ASME B18.2.2. Carbon steel (NACE) studs and nuts shall be hot dip spun galvanized in accordance with ASTM A153.

Duplex stain less steel flange, studs and nut shall be ASTM A 453 Gr 660 Cl A.

#### **5.17 GASKETS**

Gasket materials must be such that the internal fluids shall have no harmful or corrosive effects on them.

Gaskets for raised face flanges shall be spiral wound, non-asbestos filled, with 316 stainless steel in accordance with ASME B16.20, with the exception that compressed fibre gaskets complying with ASME B16.21 are acceptable for cooling water service.

Full-face gaskets for flat face flanges shall be made from 3-mm (1/8") thick compressed, oil-resisting non-asbestos sheets, or neoprene. Materials shall be specified in the pipe class Data Sheets.

Ring gasket for ring type joint shall be octagonal and shall be as per ASME B 16.20. Rings for API 5000# flanges shall conform to API 6A. Type RX rings shall be used.

#### **5.18 CERTIFICATION DOCUMENTS**

All pressure parts material certification shall be traceable to heat numbers. Certificates, including all material certificates, Mechanical test certificates, welding qualification certificates, heat treatment certificates and hydrostatic test certificates duly certified by

|             |                    |           |          |            |
|-------------|--------------------|-----------|----------|------------|
| FORMAT No.  | Ref. PROCEDURE No. | ISSUE No. | REV. No. | REV. DATE: |
| ODS/SOF/004 | ODS/SOP/023        | 01        | 00       | 21.07.2010 |

|   |   |   |                |        |
|---|---|---|----------------|--------|
|  | <b>Offshore Design Section<br/>Engineering Services<br/>ISO – 9001:2008</b> | <b>FUNCTIONAL<br/>SPECIFICATION FOR<br/>PIPING DESIGN</b> | Spec. No.      | 2004 A |
|   |   |   | Rev. No.       | 9      |
|   |   |   | Discipline     | PIPING |
|   |   |   | Page: 35 OF 75 |        |

company recognized third party inspection agency shall be available at final inspection and for counter signature by the certification authority and stored by the Contractor for a minimum of 5 years after acceptance of the piping by the Company. Pressure retaining parts shall be clearly marked to allow verification of tractability.

## 6. TECHNICAL NOTES OF PIPING COMPONENTS

### 6.1 PIPE

Pipe dimensions shall be in accordance with ASME B36.10 for carbon steel pipe and ASME B36.19 for stainless steel pipe and BS2871 Part 2 for 90/10 Cu-Ni pipe work up to DN 500 (20").

Nominal pipe sizes DN 30 (1¼"), DN65 (2½"), DN85 (3½") and DN 125 (5") shall not be used except where they are required for connections to equipment of standard design or where specific velocities must be maintained. When these sizes are used on equipments, the connecting piping shall be increased or decreased to standard sizes as close to equipment as practical.

Company approval shall be sought prior to using such components.

The minimum nominal pipe size shall be DN20 (¾") except for air, instrument air, water and manufacturer's standard equipment piping.

All nipples shall be made from pipe of same quality as that of parent piping

Carbon steel pipe DN40 (1½") and smaller used for process lines and other lines carrying flammable or toxic fluids shall have wall thickness at least Schedule 80.

Galvanized pipe shall not be bent or welded. Piping requiring bending, welding or threading shall be galvanized after fabrication.

All CS Pipes shall be seamless up to 16". Above 16" pipes shall be SAW with 100% radiography. Weld joint factor to be considered shall be as per ASME B 31.3/ASME B 31.4/ASME B 31.8 (As applicable).

All 90/10 Cu-Ni pipes shall be seamless up to 16". Above 16" pipes shall be SAW with 100% radiography. Weld joint factor to be considered shall be as per ASME B 31.3.

|             |                    |           |          |            |
|-------------|--------------------|-----------|----------|------------|
| FORMAT No.  | Ref. PROCEDURE No. | ISSUE No. | REV. No. | REV. DATE: |
| ODS/SOF/004 | ODS/SOP/023        | 01        | 00       | 21.07.2010 |

|   |   |   |                       |               |
|---|---|---|-----------------------|---------------|
|  | <b>Offshore Design Section<br/>Engineering Services<br/>ISO – 9001:2008</b> | <b>FUNCTIONAL<br/>SPECIFICATION FOR<br/>PIPING DESIGN</b> | <b>Spec. No.</b>      | <b>2004 A</b> |
|   |   |   | <b>Rev. No.</b>       | <b>9</b>      |
|   |   |   | <b>Discipline</b>     | <b>PIPING</b> |
|   |   |   | <b>Page: 36 OF 75</b> |               |

All stainless steel including DSS piping up to 8” shall be seamless. Above 8” shall be EFW with 100% radiography. Weld joint factor to be considered shall be as per ASME B 31.3.

All pipes shall have bevel end for size equal to and above 2” and plain end below 2”.

## 6.2 TUBING

All tubing, unless otherwise noted, shall be 316 SS/316L SS seamless with wall thickness appropriate for the service & piping class.

Refer to the Specification FS 3507 for Instrumentation Bulk item requirements.

## 6.3 FITTINGS

All unions DN25 (1”) and larger shall comply with BS 3799.

No street elbows or threaded bushings shall be used in piping. Hexagonal bushings (but no flush bushings) may only be used with tubing fittings for connection to instruments, or as otherwise specifically approved by the Company.

The thickness of reducing fittings shall match the wall thickness of the higher schedule pipe wall. The fitting wall thickness shall be tapered on a 1:4 gradient to ensure that the pipefitting wall thickness matches the lower schedule pipe wall.

All 90°-weld elbows shall be long radius, unless restricted by available space. Short radius (SR) welding elbows shall not be used unless absolutely required for clearance purpose with prior approval from the company. If short radius weld elbows are used, they shall be de-rated to 80% of the calculated allowable working pressure if subject to pulsations.

Thickness for fitting shall be same as that of corresponding pipe. Short radius elbows, which have been de-rated as specified above, may require a wall thickness greater than that of the connecting pipe.

Welded fittings materials shall be compatible with the piping material.

Fittings DN40 (1-1/2”) and smaller shall be socket weld except as dictated.

Fittings DN50 (2”) and larger shall be butt welded except as dictated.

|             |                    |           |          |            |
|-------------|--------------------|-----------|----------|------------|
| FORMAT No.  | Ref. PROCEDURE No. | ISSUE No. | REV. No. | REV. DATE: |
| ODS/SOF/004 | ODS/SOP/023        | 01        | 00       | 21.07.2010 |

|   |   |   |                |        |
|---|---|---|----------------|--------|
|  | <b>Offshore Design Section<br/>Engineering Services<br/>ISO – 9001:2008</b> | <b>FUNCTIONAL<br/>SPECIFICATION FOR<br/>PIPING DESIGN</b> | Spec. No.      | 2004 A |
|   |   |   | Rev. No.       | 9      |
|   |   |   | Discipline     | PIPING |
|   |   |   | Page: 37 OF 75 |        |

Mitred joints shall not be used.

#### 6.4 BRANCH CONNECTIONS

Branch connections shall be in accordance with API RP 14E. Branch connections for non-ferrous materials shall be as per manufactures standard with prior approval from Company. Contractor to prepare and list the branch tables in piping class data sheets. The lists shall show requirements for branches at 90° angles to the header & branching component with sufficient details.

#### 6.5 FLANGES

Flanges shall be in accordance with ASME B16.5 for DN50 to DN600 and with ASME B16.47 Series A for flanges DN650 and larger. They shall be raised face unless otherwise shown on the individual vessel data sheets and/or drawings. Non-standard size flanges shall be calculated in accordance with ASME Code Rules & prior approval shall be sought from company.

Flanges shall be raised face up to #600 rating and shall be RTJ above #600 rating.

API ring joint 5000-psi flanges shall comply with API 6A.

ASME ring joint (RTJ) flanges shall have octagonal grooves conforming to ASME B 16.5.

API ring joint flanges shall conform to API specification 6A.

The bolt-hole pitch circle diameter for orifice flanges DN50, DN80 and DN100 shall be 1.6 mm smaller than specified in ASME B16.5.

Flange bolt-holes shall straddle the piping vertical and horizontal centerlines.

Flanges in the piping shall be kept to a minimum. Flanges shall be installed only to facilitate construction, maintenance and inspection and in cases where process conditions dictate.

|             |                    |           |          |            |
|-------------|--------------------|-----------|----------|------------|
| FORMAT No.  | Ref. PROCEDURE No. | ISSUE No. | REV. No. | REV. DATE: |
| ODS/SOF/004 | ODS/SOP/023        | 01        | 00       | 21.07.2010 |

|   |   |   |                       |               |
|---|---|---|-----------------------|---------------|
|  | <b>Offshore Design Section<br/>Engineering Services<br/>ISO – 9001:2008</b> | <b>FUNCTIONAL<br/>SPECIFICATION FOR<br/>PIPING DESIGN</b> | <b>Spec. No.</b>      | <b>2004 A</b> |
|   |   |   | <b>Rev. No.</b>       | <b>9</b>      |
|   |   |   | <b>Discipline</b>     | <b>PIPING</b> |
|   |   |   | <b>Page: 38 OF 75</b> |               |

Spectacle blinds rather than spade blinds shall be provided where required. Thickness of blinds shall be calculated in accordance with ASME B31.3. Pairs of spacers and blinds shall be used instead of spectacle blinds of size DN 350 and larger.

Class 400 flanges shall not be used unless required to match nozzles of compressors, pump, turbines, etc. of standard design supplied by equipment manufacturers.

Smooth finish on flanges shall be 32-63 AARH.

Wherever face finish is not mentioned, it shall be serrated spiral/concentric

## 6.6 BOLTING

Flange bolting of nominal size M40 (1-1/2”) and above shall be subject to bolt tensioning. Flange bolting shall be a full threaded alloy steel stud bolt, each with two heavy hexagonal nuts. Stud bolts shall have full continuous threads and have lengths in accordance with B16.5 with the provision that a minimum of one (1) thread and a maximum of three (3) threads outside each nut and complete with 2 nuts to facilitate bolt tensioning.

Stud bolts shall be used for all piping closures except where tapped wafer valves dictate the use of machine bolts.

## 6.7 VALVES

Valve bodies, seals, etc., shall be in accordance with the design pressure and design temperature of the applicable project Specification. Valves may be supplied with higher design pressure or design temperature trims in order to meet the service requirements.

Each valve shall be supplied with a stainless steel tag, attached to the gland bolting, or hand wheel, with stainless steel wire, bearing the applicable valve identification, Tag Number and Purchase Order number.

Ball valves shall comply with API 6D or BS EN ISO 17292/BS 5351 (below 2”). All ball valve body patterns shall be long pattern to ASME B16.10 and shall be quarter-turn design. Soft seals and seats for ball valves shall be suitable for the maximum applied differential pressure, the service fluid and the specified pressure and temperature ratings.

|             |                    |           |          |            |
|-------------|--------------------|-----------|----------|------------|
| FORMAT No.  | Ref. PROCEDURE No. | ISSUE No. | REV. No. | REV. DATE: |
| ODS/SOF/004 | ODS/SOP/023        | 01        | 00       | 21.07.2010 |

|   |   |   |                |        |
|---|---|---|----------------|--------|
|  | <b>Offshore Design Section<br/>Engineering Services<br/>ISO – 9001:2008</b> | <b>FUNCTIONAL<br/>SPECIFICATION FOR<br/>PIPING DESIGN</b> | Spec. No.      | 2004 A |
|   |   |   | Rev. No.       | 9      |
|   |   |   | Discipline     | PIPING |
|   |   |   | Page: 39 OF 75 |        |

As a general philosophy, ingress of sand particle is envisaged in well fluid and injection water services unless indicated otherwise elsewhere in the bid hence all valves are required to be metal seated in well fluid and injection water service. Trim of the metal seated Ball Valves as a minimum shall be Tungsten Carbide coated. Minimum surface hardness shall be 1050 Vickers and minimum coating thickness of finished and machined surface of Tungsten Carbide shall be 150 $\mu$  to 250 $\mu$ . Uses of soft seated valves are allowed only when no erosive effect is envisaged due to abrasive particle. Contractor is required to establish the same during detail engineering.

Check valves shall comply with BS 1868 or BS 5352/BS EN ISO 15761 or API 602. Swing type check valves shall have bolted bonnets. Where check valves are placed in vertical runs, valves shall be equipped with flapper stops. The stops shall not be connected to bonnet taps in any way.

In pulsating, turbulent or high velocity flow, to avoid possibility of slamming in check valve tilting disc slam check valve shall be preferred.

For heavy check valves, provisions shall be available for lifting by way of lugs, eyebolts and such standard devices

Gate valves shall comply with API 600, 602 or 603 as applicable. Gate and butterfly valves shall be used in “clean” non-hydrocarbon services like firewater services only.

In hydro carbon services for #900 & above, gate valves may be used in hydrocarbon service in place of ball valves for sizes up to 1.5”.

Globe valves shall comply with API 602/ BS 1873/ BS 5352/BS EN ISO 15761.

Plug valves shall comply with BS 1873/ BS 5353.

Butterfly valves shall comply with BS 5155/BS EN 593/ API 609

Steel and alloy valves shall be designed and tested in accordance with the applicable codes as per type & class of valves are as under: -

1. ASME 150# - Designed and examined in accordance with ASME B16.34 and tested in accordance with API 598.

|             |                    |           |          |            |
|-------------|--------------------|-----------|----------|------------|
| FORMAT No.  | Ref. PROCEDURE No. | ISSUE No. | REV. No. | REV. DATE: |
| ODS/SOF/004 | ODS/SOP/023        | 01        | 00       | 21.07.2010 |



|   |   |   |                |        |
|---|---|---|----------------|--------|
|  | <b>Offshore Design Section<br/>Engineering Services<br/>ISO – 9001:2008</b> | <b>FUNCTIONAL<br/>SPECIFICATION FOR<br/>PIPING DESIGN</b> | Spec. No.      | 2004 A |
|   |   |   | Rev. No.       | 9      |
|   |   |   | Discipline     | PIPING |
|   |   |   | Page: 40 OF 75 |        |

2. ASME 300# through ASME 2500# - Designed and tested in accordance with API 6D for ball valves & other applicable codes as per type of valves.
3. API 2000# through API 5000# - Designed and tested in accordance with API 6A.
4. All hydrocarbon valves with non-metallic seats and seals including ball valve and butterfly valve shall be fire-safe, tested in accordance with API 607, API 6FA, ISO 10497 or BS 6755 PART II. The ball valves shall be fire safe in accordance with the requirements of either API 6FA (for trunnion ball valves) or API 607/ISO 10497 (for floating ball valves). All valves shall be witnessed & certified by a company approved third-party agency.
5. Metal Seated Ball valve shall be tested as per API 6D or API 6A as applicable. Leakage rate shall not be more than Rate – “B” as per API 6D/ISO 5208.

Valves i.e. Ball, Gate, Globe, Choke and Needle used in service with more than 230ppm of H<sub>2</sub>S shall be designed for Fugitive Emission from external leakage paths of Valve stem seals and body joints/Seals. Each type of valve design shall be certified by type testing as per BS EN ISO 15848-1. Each valve as a minimum shall comply with:

- (a) Tightness Class as per Table -1 (Based on type of stem seal) and Leakage from body seals as per Table-2 of BS EN ISO 15848-1.
- (b) Endurance Class - CO1 of BS EN ISO 15848-1
- (c) Temperature Class – (t-RT) & (t200<sup>0</sup>C) of BS EN ISO 15848-1

The type test for each design of Valve shall be witnessed and certified by ONGC approved Third Party Inspection Agency.

During production of Valves, each valves which has been type tested as per BS EN ISO 15848-1 shall be revalidated by testing for tightness class as per BS EN ISO 15848-2. Tightness class test for each Valve shall be witnessed and certified by ONGC approved Third Party Inspection Agency.

Gate, globe, angle, ball and check valves shall be supplied with replaceable seats. Where replaceable seats are not available, the valve seat shall be stellite and welded into the valve body.

|             |                    |           |          |            |
|-------------|--------------------|-----------|----------|------------|
| FORMAT No.  | Ref. PROCEDURE No. | ISSUE No. | REV. No. | REV. DATE: |
| ODS/SOF/004 | ODS/SOP/023        | 01        | 00       | 21.07.2010 |

|   |   |   |                |        |
|---|---|---|----------------|--------|
|  | <b>Offshore Design Section<br/>Engineering Services<br/>ISO – 9001:2008</b> | <b>FUNCTIONAL<br/>SPECIFICATION FOR<br/>PIPING DESIGN</b> | Spec. No.      | 2004 A |
|   |   |   | Rev. No.       | 9      |
|   |   |   | Discipline     | PIPING |
|   |   |   | Page: 41 OF 75 |        |

Valves designated “LO” (Locked Open) or “LC” (Locked Closed) on drawings, shall be provided with locking devices. Valves shall be furnished with the locking tab hardware installed.

Open-ended valves shall be equipped with threaded plugs or blind flanges.

- a) Ball shall be solid type unless otherwise specified.
- b) All valves shall be forged type for 1 ½” & below.
- c) All valves shall be supplied with position indicator.
- d) All trunnion mounted ball valves shall be supplied with double block & bleed arrangement

Every block valve shall be provided with a lever, handle, or hand wheel as necessary to operate the valve.

Gear operators shall be heavy-duty lubricated type and shall be completely housed in a weatherproof enclosure.

Socket-weld valves shall be bolted body or top entry design, allowing removal of seats/seals for heat protection, prior to welding, without loss of assembly orientation. Single piece valve bodies, or valves bodies assembled by screwed-together components, shall not be used with socket-weld ends.

If an overlay weld-deposit is used for the body seat ring, seating surface, the seat ring base material shall be at least equal to the corrosion resistance of the material of the shell.

All valves shall be reduced bore unless & otherwise specified. Full bore valves shall be provided for all piggable lines.

Valve body thickness shall be as per relevant valve standard, shall be in accordance with ASME B16.34.

Valve body of Cast material of Construction shall be 100% radiographed irrespective of rating in accordance with ASME B16.34 Annexure B.

|             |                    |           |          |            |
|-------------|--------------------|-----------|----------|------------|
| FORMAT No.  | Ref. PROCEDURE No. | ISSUE No. | REV. No. | REV. DATE: |
| ODS/SOF/004 | ODS/SOP/023        | 01        | 00       | 21.07.2010 |

|   |   |   |                       |               |
|---|---|---|-----------------------|---------------|
|  | <b>Offshore Design Section<br/>Engineering Services<br/>ISO – 9001:2008</b> | <b>FUNCTIONAL<br/>SPECIFICATION FOR<br/>PIPING DESIGN</b> | <b>Spec. No.</b>      | <b>2004 A</b> |
|   |   |   | <b>Rev. No.</b>       | <b>9</b>      |
|   |   |   | <b>Discipline</b>     | <b>PIPING</b> |
|   |   |   | <b>Page: 42 OF 75</b> |               |

Valves body other than Cast material of Construction shall be radio graphed to the following extents: -

|   |      |
|---|------|
| ASME 150#, DN600 or smaller                     | 25%  |
| ASME 150#, DN650 or larger                      | 100% |
| ASME 300#, DN400 or smaller                     | 25%  |
| ASME 300#, DN450 or larger                      | 100% |
| ASME 600# and higher                            | 100% |
| Carbon steel to NACE requirements               | 100% |
| Stainless and high alloy steel (Cast or Forged) | 100% |
| Other alloys (Cast or Forged)                   | 100% |

UT in place of radio graphy is acceptable for forged valve in accordance with ASME B16.34.

Socket-weld-end valves with non-metallic seats or seals shall be provided with 80mm long nipples having materials and thickness equivalent to those specified in the relevant piping specifications. These nipples shall be welded to the valves on both ends before the packing, seats and seals are fitted.

Stem protection is required for all carbon steel gate and globe valves where 13% Chromium trims are specified. The stems shall be totally enclosed in sleeves, which shall be packed with grease.

By-pass requirement for gate valves shall be provided as per following. Basic design of bypass shall be MSS-SP-45 & ASME B-16.34

|                |                         |
|----------------|-------------------------|
| ASME 150 class | on sizes 26” and above. |
| ASME 300 class | on sizes 16” and above. |
| ASME 600 class | on sizes 6” and above.  |

|             |                    |           |          |            |
|-------------|--------------------|-----------|----------|------------|
| FORMAT No.  | Ref. PROCEDURE No. | ISSUE No. | REV. No. | REV. DATE: |
| ODS/SOF/004 | ODS/SOP/023        | 01        | 00       | 21.07.2010 |

|   |   |   |                       |               |
|---|---|---|-----------------------|---------------|
|  | <b>Offshore Design Section<br/>Engineering Services<br/>ISO – 9001:2008</b> | <b>FUNCTIONAL<br/>SPECIFICATION FOR<br/>PIPING DESIGN</b> | Spec. No.             | <b>2004 A</b> |
|   |   |   | Rev. No.              | <b>9</b>      |
|   |   |   | Discipline            | <b>PIPING</b> |
|   |   |   | Page: <b>43 OF 75</b> |               |

|   |                      |                        |
|---|----------------------|------------------------|
| ASME 900 class  |                      | on sizes 4” and above. |
| ASME 1500 class   |                      | on sizes 4” and above. |
| ASME 2500 class   |                      | on sizes 3” and above. |
| <p><b>By-pass valve shall be a globe valve. The sizes shall be as under:</b></p>  |                      |                        |
| On main valve   | $\leq 4$ ”           | 1/2” or more           |
| On main valve   | $> 4$ ” but $< 10$ ” | 3/4” or more           |
| On main valve   | $\geq 10$ ”          | 1” or more.            |
| <p>Valves with by-pass shall have the direction of flow marked on the main valve. By-pass attachment to the main valve body shall not be screwed. All fillet welds for by-pass installation shall be 100% examined by DP/MP test.</p> |                      |                        |
| <p>The by-pass piping arrangement shall be such that clearance between main valve body &amp; bypass assembly shall be the minimum possible for layout reasons.</p>  |                      |                        |
| <p>Material of construction of yoke shall be minimum equivalent to body/bonnet material.</p>  |                      |                        |
| <p>Stellite / hard facing by deposition shall be minimum 1.6 mm.</p>  |                      |                        |
| <p>Soft-seated Ball, plug &amp; butterfly valves shall be supplied with antistatic devices.</p>   |                      |                        |
| <p>Soft seated Ball valves shall be floating ball type/trunion mounted type as per following:</p>   |                      |                        |
| 150#  | 8” & below           | floating ball          |
|   | 10” & above          | trunion mounted        |
| 300#  | 4” & below           | floating ball          |
|   | 6” & above           | trunion mounted        |
| 600#  | 1.5” & below         | floating ball          |
|   | 2” & above           | trunion mounted        |

|             |                    |           |          |            |
|-------------|--------------------|-----------|----------|------------|
| FORMAT No.  | Ref. PROCEDURE No. | ISSUE No. | REV. No. | REV. DATE: |
| ODS/SOF/004 | ODS/SOP/023        | 01        | 00       | 21.07.2010 |

For metal seated ball valve, trunion mounted ball valve in place of floating ball valve is acceptable. However, vise-versa is not acceptable.

Generally the valves are hand wheel or lever operated. Gear operation shall be provided as under:

| VALVE TYPE   | CLASS      | SIZE REQUIRING GEAR OPER. |
|--|------------|---------------------------|
| Gate valve & diaphragm                                   | 150 class  | 14” and larger            |
|  | 300 class  | 14” and larger            |
|  | 600 class  | 12” and larger            |
|  | 900 class  | 6” and larger             |
|  | 1500 class | 3” and larger             |
|  | 2500 class | 3” and larger             |
| Globe valve  | 150 class  | 10” and larger            |
|  | 300 class  | 8” and larger             |
|  | 600 class  | 6” and larger             |
|  | 900 class  | 6” and larger             |
|  | 1500 class | 3” and larger             |
|  | 2500 class | 3” and larger             |
| Ball/plug Valve (other than pressure balance plug valve) | 150 class  | 6” and larger             |
|  | 300 class  | 6” and larger             |
|  | 600 class  | 4” and larger             |
|  | 900 class  | 3” and larger             |
|  | 1500 class | 3” and larger             |

Where gear operator is not called for as per above but vendor recommends a gear operator, he shall highlight such cases & obtain company’s approval. For basis of finalization of gear operator vendor shall follow the guide line as mentioned below:

Torque and Gear Ratio required shall be based on guide line as indicated below:

Valve hand wheel diameter shall not exceed 750mm and lever length shall not exceed 500mm on either side. Effort shall not exceed 35 Kg at hand wheel periphery. Failing to meet above criteria vendor shall offer gear operated Valves even if valve does not fall into the category indicated in the above table

|   |   |   |                |        |
|---|---|---|----------------|--------|
|  | <b>Offshore Design Section<br/>Engineering Services<br/>ISO – 9001:2008</b> | <b>FUNCTIONAL<br/>SPECIFICATION FOR<br/>PIPING DESIGN</b> | Spec. No.      | 2004 A |
|   |   |   | Rev. No.       | 9      |
|   |   |   | Discipline     | PIPING |
|   |   |   | Page: 45 OF 75 |        |

The following guide line shall be followed for gear box/hand wheel/lever:

|  |  |
|--|--|
| Hand wheel -operated:<br>Max. Single hand forces: 200 N.<br>Max. Diameter of hand wheel: 750 mm.<br>(Max. torques 150 Nm). | Lever-operated:<br>Max. Force: 350 N.<br>Max. Length of lever: 600 mm.<br>(Max. torques 270 Nm). |
|--|--|

Manual and gear operated valve shall be operated without use of any extension device. The torque/force value shall be recorded during the test. Torque value recorded shall not be more than indicated above.

Valve hand wheel/Lever shall be solid malleable Iron to ASTM A 47 (or any other applicable standard)/ Solid SS-316 material as per suitable MOC of the valve for required torque. In case of Malleable Iron, hand wheel shall be galvanized with thickness suitable to marine environment and subsequently painted as per FS 2005.

Vendor shall declare the operating torque value of each valve based on above guide line and carryout the required test as indicated in clause no. 6.7.1.1 through 6.7.1.7

#### 6.7.1 TEST REQUIREMENTS OF VALVES

This clause elaborates minimum mandatory tests required to be carried out by the vendor at his premises, at fabrication yard of LSTK Contractor and offshore location. The tests indicated against this clause are related to the valve only, other material tests as required by relevant clause of this specification shall be complied by the vendor in addition to the tests indicated under this clause.

##### 6.7.1.1 SHUT DOWN VALVE

- (a) Material tests as per clauses no. 5 and sub clauses of FS 2004 A.
- (b) Radiography of shell/body of the valve.
- (c) DPT or MPT (as applicable) of the items/parts of the valve.
- (d) Fire type test with respect to design of the valve.
- (e) Hydrostatic Shell Test.
- (f) Hydrostatic Seat Test.
- (g) Pneumatic Seat Test.
- (h) Check Torque of the Valve against zero differential pressure (as indicated in relevant para. of clause 6.7 of FS 2004A).
- (i) Check Torque of the Valve against rated full differential pressure (as indicated relevant para. of clause 6.7 of FS 2004A).
- (j) Check Torque of the Actuator as per FS 2004D.
- (k) Type test of Fugitive Emission as per BS EN ISO 15848-1(If applicable).
- (l) Fugitive Emission test as per BS EN ISO 15848-2 (If applicable).
- (m) Check surface preparation and all the stages of protective coating as per FS 2005.
- (n) Functional Test of the Valve – Shut Down Valve be pressurized to full differential rated pressure with liquid same as used for hydro test and thereafter shut down valve be operated by giving full rated pressure to actuator and rated voltage to Solenoid Valve. Full opening

|             |                    |           |          |            |
|-------------|--------------------|-----------|----------|------------|
| FORMAT No.  | Ref. PROCEDURE No. | ISSUE No. | REV. No. | REV. DATE: |
| ODS/SOF/004 | ODS/SOP/023        | 01        | 00       | 21.07.2010 |

|   |   |   |                |        |
|---|---|---|----------------|--------|
|  | <b>Offshore Design Section<br/>Engineering Services<br/>ISO – 9001:2008</b> | <b>FUNCTIONAL<br/>SPECIFICATION FOR<br/>PIPING DESIGN</b> | Spec. No.      | 2004 A |
|   |   |   | Rev. No.       | 9      |
|   |   |   | Discipline     | PIPING |
|   |   |   | Page: 46 OF 75 |        |

and closing shall be checked. The operation of the valve shall be smooth and jerk free. This activity shall be repeated 5 times at manufacturer's location.

Sequence of operation in the entire test shall be alternate with one cycle with zero differential pressure across the valve and one cycle with full differential pressure across the valve.

Same activity shall be repeated 5 times with zero differential pressure across the valve on installation at fabrication yard and 5 times at offshore.

- (o) Valve shall be API Monogrammed which are designed under API Codes and Standards, as applicable.

#### 6.7.1.2 MOTORIZED BALL VALVE

- a) Material tests as per clauses no. 5 and sub clauses of FS 2004 A.
- b) Radiography of shell/body of the valve.
- c) DPT or MPT (As applicable) of the items/parts of the valve.
- d) Fire type test with respect to design of the valve.
- e) Hydrostatic Shell Test.
- f) Hydrostatic Seat Test.
- g) Pneumatic Seat Test.
- h) Check Torque of the Valve against no differential pressure zero differential pressure (as indicated in relevant para. of clause 6.7 of FS 2004A).
- i) Check Torque the Valve against rated full differential pressure (as indicated relevant para. of clause 6.7 of FS 2004A).
- j) Check Torque of the Actuator as per FS 2004D.
- k) Type test of Fugitive Emission as per BS EN ISO 15848-1 (If applicable).
- l) Fugitive Emission test as per BS EN ISO 15848-2 (If applicable).
- m) Check surface preparation and all the stages of protective coating as per FS 2004D.
- n) Functional Test of the Valve – Motor Operated Valve (MOV) shall be pressurized to full rated differential pressure with liquid same as used for hydro test and thereafter MOV shall be operated by giving full rated power to actuator. Full opening and closing shall be checked. The operation of the valve shall be smooth and jerk free. There shall be not abrupt fluctuation of current except during brake to open and Brake to close. The operation of the valve shall be smooth and jerk free. This activity shall be repeated 5 times at manufacturer's location

Sequence of operation in the entire test shall be alternate with one cycle with zero differential pressure across the valve and one cycle with full differential pressure across the valve.

|             |                    |           |          |            |
|-------------|--------------------|-----------|----------|------------|
| FORMAT No.  | Ref. PROCEDURE No. | ISSUE No. | REV. No. | REV. DATE: |
| ODS/SOF/004 | ODS/SOP/023        | 01        | 00       | 21.07.2010 |

|   |   |   |                |        |
|---|---|---|----------------|--------|
|  | <b>Offshore Design Section<br/>Engineering Services<br/>ISO – 9001:2008</b> | <b>FUNCTIONAL<br/>SPECIFICATION FOR<br/>PIPING DESIGN</b> | Spec. No.      | 2004 A |
|   |   |   | Rev. No.       | 9      |
|   |   |   | Discipline     | PIPING |
|   |   |   | Page: 47 OF 75 |        |

Same activity shall be repeated 5 times with zero differential pressure across the valve on installation at fabrication yard and 5 times at offshore.

- (o) Valve shall be API Monogrammed which are designed under API Codes and Standards, as applicable.

#### 6.7.1.3 BALL VALVE.

- (a) Material tests as per clauses no. 5 and sub clauses of FS 2004 A.
- (b) Radiography of shell/body of the valve.
- (c) DPT or MPT (As applicable) of the items/parts of the valve.
- (d) Fire type test with respect to design of the valve.
- (e) Hydrostatic Shell Test.
- (f) Hydrostatic Seat Test.
- (g) Pneumatic Seat Test.
- (h) Check Torque of the Valve against no differential pressure zero differential pressure (as indicated in relevant para. of clause 6.7 of FS 2004A).
- (i) Check Torque of the Valve against rated full differential pressure (as indicated relevant para. of clause 6.7 of FS 2004A).
- (j) Not Applicable.
- (k) Type test of Fugitive Emission as per BS EN ISO 15848-1 (If applicable).
- (l) Fugitive Emission test as per BS EN ISO 15848-2 (If applicable).
- (m) Check surface preparation and all the stages of protective coating as per FS 2005.
- (n) Functional Test of the Valve – Ball Valve shall be pressurized to full rated differential pressure with liquid same as used for hydro test and thereafter shall be operated by single hand. Full opening and closing shall be checked. The operation of the valve shall be smooth. The operation of the valve shall be smooth and jerk free. This activity shall be repeated 5 times at manufacturer's location

Sequence of operation in the entire test shall be alternate with one cycle with no differential pressure across the valve and one cycle with full differential pressure across the valve.

Same activity shall be repeated 5 times with zero differential pressure across the valve on installation at fabrication yard and 5 times at offshore.

- (o) Valve shall be API Monogrammed which are designed under API Codes and Standards, as applicable.

#### 6.7.1.4 GATE VALVE.

- (a) Material tests as per clauses no. 5 and sub clauses of FS 2004 A.
- (b) Radiography of Shell/Body of the valve.
- (c) DPT or MPT (As applicable) of the items/parts of the valve.
- (d) Hydrostatic Shell Test.
- (e) Hydrostatic Seat Test.
- (f) Pneumatic Seat Test.

|             |                    |           |          |            |
|-------------|--------------------|-----------|----------|------------|
| FORMAT No.  | Ref. PROCEDURE No. | ISSUE No. | REV. No. | REV. DATE: |
| ODS/SOF/004 | ODS/SOP/023        | 01        | 00       | 21.07.2010 |



|   |   |   |                |        |
|---|---|---|----------------|--------|
|  | <b>Offshore Design Section<br/>Engineering Services<br/>ISO – 9001:2008</b> | <b>FUNCTIONAL<br/>SPECIFICATION FOR<br/>PIPING DESIGN</b> | Spec. No.      | 2004 A |
|   |   |   | Rev. No.       | 9      |
|   |   |   | Discipline     | PIPING |
|   |   |   | Page: 48 OF 75 |        |

- (g) Check Torque of the Valve against no differential pressure zero differential pressure (as indicated in relevant para. of clause 6.7 of FS 2004A).
- (h) Check Torque of the Valve against rated full differential pressure (as indicated relevant para. of clause 6.7 of FS 2004A).
- (i) Type test of Fugitive Emission as per BS EN ISO 15848-1 (If applicable).
- (j) Fugitive Emission test as per BS EN ISO 15848-2 (If applicable).
- (k) Check surface preparation and all the stages of protective coating as per FS 2005.
- (l) Functional Test of the Valve – Gate Valve shall be pressurized to full rated differential pressure with liquid same as used for hydro test and thereafter shall be operated by single hand. Full opening and closing shall be checked. The operation of the valve shall be smooth. The operation of the valve shall be smooth and jerk free. This activity shall be repeated 5 times at manufacturer’s location

Sequence of operation in the entire test shall be alternate with one cycle with no differential pressure across the valve and one cycle with full differential pressure across the valve.

Same activity shall be repeated 5 times with zero differential pressure across the valve on installation at fabrication yard and 5 times at offshore.

#### 6.7.1.5 GLOBE VALVE

- (a) Material tests as per clauses no. 5 and sub clauses of FS 2004 A.
- (b) Radiography of Shell/Body of the valve.
- (c) DPY or MPT (As applicable) NDT of the items/parts of the valve.
- (d) Hydrostatic Shell Test.
- (e) Hydrostatic Seat Test.
- (f) Pneumatic Seat Test.
- (g) Check Torque of the Valve against no differential pressure zero differential pressure (as indicated in relevant para. of clause 6.7 of FS 2004A).
- (h) Check Torque of the Valve against rated full differential pressure (as indicated relevant para. of clause 6.7 of FS 2004A).
- (i) Type test of Fugitive Emission as per BS EN ISO 15848-1 (If applicable).
- (j) Fugitive Emission test as per BS EN ISO 15848-2 (If applicable).
- (k) Check surface preparation and all the stages of protective coating as per FS 2005.
- (l) Functional Test of the Valve – Globe Valve shall be pressurized to full rated differential pressure with liquid same as used for hydro test and thereafter shall be operated by single hand. Full opening and closing shall be checked. The operation of the valve shall be smooth. The operation of the valve shall be smooth and jerk free. This activity shall be repeated 5 times at manufacturer’s location

Sequence of operation in the entire test shall be alternate with one cycle with no differential pressure across the valve and one cycle with full differential pressure across the valve.

Same activity shall be repeated 5 times with zero differential pressure across the valve on installation at fabrication yard and 5 times at offshore.

|             |                    |           |          |            |
|-------------|--------------------|-----------|----------|------------|
| FORMAT No.  | Ref. PROCEDURE No. | ISSUE No. | REV. No. | REV. DATE: |
| ODS/SOF/004 | ODS/SOP/023        | 01        | 00       | 21.07.2010 |

|   |   |   |                |        |
|---|---|---|----------------|--------|
|  | <b>Offshore Design Section<br/>Engineering Services<br/>ISO – 9001:2008</b> | <b>FUNCTIONAL<br/>SPECIFICATION FOR<br/>PIPING DESIGN</b> | Spec. No.      | 2004 A |
|   |   |   | Rev. No.       | 9      |
|   |   |   | Discipline     | PIPING |
|   |   |   | Page: 49 OF 75 |        |

#### 6.7.1.6 CHECK VALVE

- (a) Material tests as per clauses no. 5 and sub clauses of FS 2004 A.
- (b) Radiography of Shell/Body of the valve.
- (c) DPT or MPT (As applicable) of the items/parts of the valve.
- (d) Hydrostatic Shell Test.
- (e) Hydrostatic Seat Test.
- (f) Pneumatic Seat Test.
- (g) Type test of Fugitive Emission as per BS EN ISO 15848-1 (If applicable).
- (h) Fugitive Emission test as per BS EN ISO 15848-2 (If applicable).
- (i) Check surface preparation and all the stages of protective coating as per FS 2005.
- (j) Functional Test of the Valve – Check Valve shall be pressurized gradually with liquid same as used for hydro test in the direction of flow and the minimum pressure at which the valve allows flow to take place shall be recorded.

#### 6.7.1.7 NEEDLE VALVE.

- (a) Material tests as per clauses no. 5 and sub clauses of FS 2004 A.
- (b) Radiography of Shell/Body of the valve.
- (c) DPT or MPT (As applicable) of the items/parts of the valve.
- (d) Hydrostatic Shell Test.
- (e) Hydrostatic Seat Test.
- (f) Pneumatic Seat Test.
- (h) Check Torque of the Valve against no differential pressure zero differential pressure (as indicated in relevant para. of clause 6.7 of FS 2004A).
- (i) Check Torque of the Valve against rated full differential pressure (as indicated relevant para. of clause 6.7 of FS 2004A).
- (k) Type test of Fugitive Emission as per BS EN ISO 15848-1 (If applicable).
- (l) Fugitive Emission test as per BS EN ISO 15848-2 (If applicable).
- (m) Check surface preparation and all the stages of protective coating as per FS 2005.
- (n) Functional Test of the Valve – Needle Valve shall be pressurized to full rated differential pressure with liquid same as used for hydro test and thereafter shall be operated by single hand. Full opening and closing shall be checked. The operation of the valve shall be smooth. The operation of the valve shall be smooth and jerk free. This activity shall be repeated 5 times at manufacturer's location

Sequence of operation in the entire test shall be alternate with one cycle with no differential pressure across the valve and one cycle with full differential pressure across the valve.

Same activity shall be repeated 5 times with zero differential pressure across the valve on installation at fabrication yard and 5 times at offshore.

#### 6.8 SPECIALTY ITEMS

Specialty Items shall be supplied, designed, tested & installed as specified in the Project Specification for specialty items spec.2004D.

|             |                    |           |          |            |
|-------------|--------------------|-----------|----------|------------|
| FORMAT No.  | Ref. PROCEDURE No. | ISSUE No. | REV. No. | REV. DATE: |
| ODS/SOF/004 | ODS/SOP/023        | 01        | 00       | 21.07.2010 |

|   |   |   |                |        |
|---|---|---|----------------|--------|
|  | <b>Offshore Design Section<br/>Engineering Services<br/>ISO – 9001:2008</b> | <b>FUNCTIONAL<br/>SPECIFICATION FOR<br/>PIPING DESIGN</b> | Spec. No.      | 2004 A |
|   |   |   | Rev. No.       | 9      |
|   |   |   | Discipline     | PIPING |
|   |   |   | Page: 50 OF 75 |        |

## 7. PIPING SYSTEM DESIGN

### 7.1 GENERAL

Design calculations for pressure/temperature wall thickness requirements, vibrations, thermal expansion and contraction, pipe weights and flexibility shall be carried out in accordance with ASME B31.3 and ASME SEC VIII and submitted to the Company for acceptance.

Piping components shall be located where they can safely be operated (where necessary) and maintained. Access shall be provided to such components, which are located out of reach from the platform deck. The use of extended hand wheel stems or chain wheels shall be avoided.

Dead ends on distribution and collection headers shall be blind flanged.

Long radius elbows shall generally be used, but for pigged lines long radius 5D bends are required. Short radius elbows shall be avoided unless essential for clearances. Cold-formed bends are not permitted. Fabricated mitre bends can only be used on gas turbine exhausts.

### 7.2 PIPE ROUTING

Piping shall be routed so as to have the short runs and minimize pipe supports whilst providing sufficient flexibility for thermal expansion and contraction and mechanical movement.

Expansion and swivel joints shall be avoided.

Large bore piping shall be designed to minimize pressure drops. Smaller bore piping shall be routed in groups where practical along main pipe racks.

Piping shall be kept within the deck boundaries.

The number of flanges and unions shall be minimized. The piping carrying hydrocarbon/hazardous chemicals in the safe area shall be of continuous length with welded joints such that no valves, regulators, flanges etc. are located in the safe area. One breakable joint in the safe area at the consumer points is permitted, with adequate safeguards.

Piping shall be routed to avoid trip and overhead hazards.

Consecutive elbows in different planes shall be avoided.

Pipe routing shall allow sufficient space for bolting up flanges or for line-up clamps to be used for field welds. Refer “Piping Clearances” described in piping fabrication (spec 2004-B).

Piping passing through firewalls shall be sealed with fire-retarding sleeves.

|             |                    |           |          |            |
|-------------|--------------------|-----------|----------|------------|
| FORMAT No.  | Ref. PROCEDURE No. | ISSUE No. | REV. No. | REV. DATE: |
| ODS/SOF/004 | ODS/SOP/023        | 01        | 00       | 21.07.2010 |

|   |   |   |                |        |
|---|---|---|----------------|--------|
|  | <b>Offshore Design Section<br/>Engineering Services<br/>ISO – 9001:2008</b> | <b>FUNCTIONAL<br/>SPECIFICATION FOR<br/>PIPING DESIGN</b> | Spec. No.      | 2004 A |
|   |   |   | Rev. No.       | 9      |
|   |   |   | Discipline     | PIPING |
|   |   |   | Page: 51 OF 75 |        |

Primary utility (air, steam and water) connections on piping shall be DN20 (¾”) or larger through the first block valve.

All instrument air and fuel gas connections shall be from the top of the associated headers.

The angle between any branch and its header shall not be less than 45°.

Scraper tees shall be provided for lines, which are to be pigged as per approved P&IDs.

**Dimensional rules for piping design are as follows:**

Min pipe dia. for thermo-well connection on straight run pipe DN 100.

Minimum pipe diameter for thermo-well connection on 90° elbow DN 80

Pipe racks to be sized to allow for the future equipment +20%.

Minimum run size of piping in racks DN 50

Spacing of instrument air take-offs along pipe rack headers ≥3000 mm  
in process areas.

Minimum slope of HP and LP flare headers Flare slope 1:500 ? 1:100

Minimum slope of open drain header 1:100

Minimum slope of closed drain header 1:100

Minimum slope of pump suction lines where vapour may be present 1:50

**7.3 PIPE SUPPORTS**

Refer piping design criteria (Vol II, sec 3.3). Piping shall be suitably supported to prevent sagging, mechanical stresses vibrations and consequent fatigue, while allowing for thermal and structural movement. Piping shall be adequately supported for the weight of piping filled with water, with attached components unsupported, subject to wind, seismic, insulation and any other applicable loads. The supports shall prevent excessive stresses in the piping and in the nozzles of the equipment to which it is connected.

Small bore instrument tubing and piping shall be adequately supported and protected from impact damage.

|             |                    |           |          |            |
|-------------|--------------------|-----------|----------|------------|
| FORMAT No.  | Ref. PROCEDURE No. | ISSUE No. | REV. No. | REV. DATE: |
| ODS/SOF/004 | ODS/SOP/023        | 01        | 00       | 21.07.2010 |

|   |   |   |                       |               |
|---|---|---|-----------------------|---------------|
|  | <b>Offshore Design Section<br/>Engineering Services<br/>ISO – 9001:2008</b> | <b>FUNCTIONAL<br/>SPECIFICATION FOR<br/>PIPING DESIGN</b> | <b>Spec. No.</b>      | <b>2004 A</b> |
|   |   |   | <b>Rev. No.</b>       | <b>9</b>      |
|   |   |   | <b>Discipline</b>     | <b>PIPING</b> |
|   |   |   | <b>Page: 52 OF 75</b> |               |

Bracing shall be provided for small-bore branches in piping adjacent to vibrating machinery.

Supports used for Cu-Ni piping shall be lined with soft packing strip or pad free from ammoniac components (EG: NEOPRENE ASTM D 2000) to prevent chafing and undue stressing and also to permit free expansion/contraction of Cu-Ni pipes between anchors (Selection of Grade & Type of Neoprene Rubber will be based on Design Temperature & as per ASTM D-2000)

#### 7.4 PIPE WAYS

Generally the piping should be routed in either platform north/south or east/west in established pipe ways. All lines running platform north/south shall be a different elevation from lines running platform east/west, as far as practical. Where possible, a minimum of 400 mm or more between changes in elevation of pipe runs in pipe ways shall be maintained.

#### 7.5 PIPING CLEARANCES

The minimum clearance for maintenance access shall be 750 mm. The following design constraints shall also apply.

|   |              |
|---|--------------|
| Minimum height from underside of pipe or insulation to high point of deck level or platform                                     | 200 mm       |
| <b><u>Control valve arrangement:</u></b><br>Preferred bottom of pipe (BOP) of control valve above deck level or platform.       | 400 mm       |
| For meter runs, the minimum clearance between BOP and deck is   | 760 mm       |
| <b><u>Pipe spacing:</u></b><br>Minimum space between pipes without flanges (after allowing for insulation and lateral movement) | 100 mm       |
| Minimum space between pipes with flanges (largest flange to pipe) (after allowing for insulation and Lateral movement)          | 100 mm       |
| - Minimum distance from pipe to face of steel work (after allowing for insulation)  | 50 mm        |
| - Minimum distance from flange to face of steel work, etc.  | 50 mm        |
| <b><u>Valve installations and access:</u></b><br>Preferred height of hand wheel from deck or platform:                          |              |
| * horizontally mounted valves   | 1000/1350 mm |
| * vertically mounted valves   | 1100/1300 mm |

|             |                    |           |          |            |
|-------------|--------------------|-----------|----------|------------|
| FORMAT No.  | Ref. PROCEDURE No. | ISSUE No. | REV. No. | REV. DATE: |
| ODS/SOF/004 | ODS/SOP/023        | 01        | 00       | 21.07.2010 |

|   |   |   |                       |               |
|---|---|---|-----------------------|---------------|
|  | <b>Offshore Design Section<br/>Engineering Services<br/>ISO – 9001:2008</b> | <b>FUNCTIONAL<br/>SPECIFICATION FOR<br/>PIPING DESIGN</b> | <b>Spec. No.</b>      | <b>2004 A</b> |
|   |   |   | <b>Rev. No.</b>       | <b>9</b>      |
|   |   |   | <b>Discipline</b>     | <b>PIPING</b> |
|   |   |   | <b>Page: 53 OF 75</b> |               |

|  |         |
|--|---------|
| Maximum height from local deck or platform level to center line of horizontal hand wheel without platform on chain wheel |         |
| Vertically-mounted valves (DN100 and larger)   | 2000 mm |
| (DN 80 and smaller)  | 2250 mm |
| * maintenance or isolation (except where temporary platforms can be used and at pipe racks)                              | 3000 mm |
| Use of chain wheels and extension stems shall be kept to a minimum. Chain shall clear operating level by:                | 1000 mm |

## 7.6 FLANGED CONNECTIONS

Flanged connections shall be minimized, being used only where frequent dismantling will be required, where specific flanged spools are needed, where needed to provide clearances for equipment removal, or for piping class or material changes.

## 7.7 THREADED PIPE-WORK

Threaded piping shall not be used to carry hydrocarbons.

Piping DN40 (1½”) and smaller, when used for services up to 1900 kPa (g) (275 psig), may be threaded with prior approval of Company.

Screwed fittings shall be rated at least 20.7 Mpa (3000 psi).

Bushings, close nipples and street elbows shall not be used.

Pipe threads shall conform to ASME B1.20.1.

Cu-Ni pipe work shall not be threaded. Adapters can be used at valves or equipment.

## 7.8 CHANGES IN MATERIALS

Where dissimilar piping materials are connected insulation gaskets shall be provided to prevent galvanic corrosion.

## 7.9 VENTS, DRAINS AND BLEEDS

High points on all lines shall be provided with DN20 (¾”) minimum plugged or flanged connections for venting during hydrostatic tests. For lines carrying hydrocarbons or other toxic fluids, the vents shall be piped to the nearest vent header.

|             |                    |           |          |            |
|-------------|--------------------|-----------|----------|------------|
| FORMAT No.  | Ref. PROCEDURE No. | ISSUE No. | REV. No. | REV. DATE: |
| ODS/SOF/004 | ODS/SOP/023        | 01        | 00       | 21.07.2010 |

|   |   |   |                |        |
|---|---|---|----------------|--------|
|  | <b>Offshore Design Section<br/>Engineering Services<br/>ISO – 9001:2008</b> | <b>FUNCTIONAL<br/>SPECIFICATION FOR<br/>PIPING DESIGN</b> | Spec. No.      | 2004 A |
|   |   |   | Rev. No.       | 9      |
|   |   |   | Discipline     | PIPING |
|   |   |   | Page: 54 OF 75 |        |

All ODD cups shall be provided with temporary (welded/bolted) plates as cover so as to prevent the clogging/chocking of drain lines during drilling operation in addition to grid plates.

Low points in lines shall be provided with drain connections of nominal sizes as follows: -

| <u>Line Size</u>          | <u>Drain Size</u>        |
|---------------------------|--------------------------|
| DN15 (½")                 | DN15 (½")                |
| DN20 (¾") TO DN 100 (4")  | DN20 (¾")                |
| DN150 (6") to DN250 (10") | DN25 (1")                |
| DN300 (12") and larger    | DN25 (1") to DN 40 (1½") |

Drains on lines other than firewater shall be provided with valves and plugged. Firewater drains do not need valves.

All hydro-test vents and drains in hydrocarbon service shall be DN 20 with valves and steel plugs unless noted otherwise.

A hydrostatic vent and drain philosophy shall be developed during detail design and shown on the isometrics.

#### **7.10 CORROSION INHIBITION AND MONITORING PIPE WORK**

Corrosion monitoring fittings shall be located as close as practical to the pipe work being monitored, where servicing access is easy and away from sources of vibration. Clearance shall be provided for the removal of the injection quills and monitoring probes, suiting each nozzle orientation and the length of the associated probe. Corrosion probe nozzles shall be mounted on the underside of the pipes.

#### **7.11 RELIEF VALVES**

Relief valve assemblies shall be installed in the vertical position, as close to the pressure source as possible, and shall be provided with permanent platform access. Relief valves shall be bolted directly to vessel and equipment nozzles.

|             |                    |           |          |            |
|-------------|--------------------|-----------|----------|------------|
| FORMAT No.  | Ref. PROCEDURE No. | ISSUE No. | REV. No. | REV. DATE: |
| ODS/SOF/004 | ODS/SOP/023        | 01        | 00       | 21.07.2010 |



|   |   |   |                |        |
|---|---|---|----------------|--------|
|  | <b>Offshore Design Section<br/>Engineering Services<br/>ISO – 9001:2008</b> | <b>FUNCTIONAL<br/>SPECIFICATION FOR<br/>PIPING DESIGN</b> | Spec. No.      | 2004 A |
|   |   |   | Rev. No.       | 9      |
|   |   |   | Discipline     | PIPING |
|   |   |   | Page: 55 OF 75 |        |

Relief valve piping shall be designed to withstand reaction forces and moments caused by the valve discharging.

Piping from relief valves to closed systems shall slope toward the headers and enter them from above, or, where that is not practical, shall have DN20 (¾”) drains in safe areas. Headers shall have at least 1:100 slopes toward downstream.

Refer to the Project Specification for General Instrumentation.

### 7.12 CONTROL VALVES

Control valves shall preferably be installed in horizontal lines, with the actuator in the vertical position. Each valve shall be located as close as possible to the item of plant under control and shall be easily accessible from the deck or permanent platform.

Where control valves are less than line size, reducing spools shall be made long enough to permit bolt removal.

Consideration shall be made for removal or withdrawal of valves or part of valves for maintenance.

Refer to the Project Specification for Instrumentation for additional requirements.

### 7.13 ISOLATIONS

Piping shall be designed, so the connections to equipment and vessels can be isolated for safe maintenance. This may be accomplished by providing for the insertion of blind flanges at strategic points or removable spools if blinding is not practical due to line size. All vessels containing hydrocarbons or other hazardous fluids and which would involve personnel entry during maintenance require such blinds.

Blinds shall be located so that insertion can be made from the deck or permanent platforms or access ways. Permanent hook eyes shall be provided above blinds, which weigh more than 25 kg. Where blinds are not required for isolation, valves must be provided for safe isolation.

Double block and bleed isolation shall be provided wherever shown in P&ID.

|             |                    |           |          |            |
|-------------|--------------------|-----------|----------|------------|
| FORMAT No.  | Ref. PROCEDURE No. | ISSUE No. | REV. No. | REV. DATE: |
| ODS/SOF/004 | ODS/SOP/023        | 01        | 00       | 21.07.2010 |



|   |   |   |                       |               |
|---|---|---|-----------------------|---------------|
|  | <b>Offshore Design Section<br/>Engineering Services<br/>ISO – 9001:2008</b> | <b>FUNCTIONAL<br/>SPECIFICATION FOR<br/>PIPING DESIGN</b> | <b>Spec. No.</b>      | <b>2004 A</b> |
|   |   |   | <b>Rev. No.</b>       | <b>9</b>      |
|   |   |   | <b>Discipline</b>     | <b>PIPING</b> |
|   |   |   | <b>Page: 56 OF 75</b> |               |

#### **7.14 FIRE SUPPRESSION SYSTEM**

Refer design criteria of the Mechanical and safety & life saving equipment (Vol II sec 3.7) and functional safety specification (spec 5102) for fire suppression attached elsewhere in bid package.

#### **7.15 CUPRO-NICKEL PIPE WORK**

Cupro-Nickel or Copper-Nickel (Cu-Ni) piping shall be used for firewater deluge systems.

All Cu-Ni piping shall be designed such that velocity in piping does not exceed the values given in project specifications. However, in special circumstances such as downstream of control valves, orifice plate, etc, where fluid velocity may exceed those given in the design criteria special material such as DSS/SDSS/Monel subject to company's approval may be used to withstand higher velocities. When one side is ASME Class 150 Cu Ni and other side is of higher rating carbon steel, a spool of carbon steel having one end of higher rating CS flange and other of lower rating CS flange shall be inserted which also acts as a sacrificial piece

Supports for Cu-Ni piping shall be lined with soft packing pads, neoprene or similar, which shall be free of ammonia compounds.

#### **7.16 COPPER PIPING**

Copper (Cu) piping shall be used for potable and other clean water systems.

#### **7.17 GRE PIPING SYSTEMS**

Glass-Reinforced Epoxy (GRE) piping shall be used for water services where there is little risk of physical impact, typically for overboard lines.

When a GRE pipe penetrates a fire rated wall or floor, the GRE shall be substituted by a flanged metallic spool piece, fabricated from a material suitable for the proposed service.

GRE piping shall be enclosed in one size higher metallic material when there is risk of moderate physical impact.

#### **7.18 PIPING ON AREAS SUBJECT TO DIFFERENTIAL MOVEMENT**

The design of the piping on such areas (if any) shall take into account the differential movement between the two structures under extreme (100 years) storm conditions and thermal expansion

|             |                    |           |          |            |
|-------------|--------------------|-----------|----------|------------|
| FORMAT No.  | Ref. PROCEDURE No. | ISSUE No. | REV. No. | REV. DATE: |
| ODS/SOF/004 | ODS/SOP/023        | 01        | 00       | 21.07.2010 |

|   |   |   |                |        |
|---|---|---|----------------|--------|
|  | <b>Offshore Design Section<br/>Engineering Services<br/>ISO – 9001:2008</b> | <b>FUNCTIONAL<br/>SPECIFICATION FOR<br/>PIPING DESIGN</b> | Spec. No.      | 2004 A |
|   |   |   | Rev. No.       | 9      |
|   |   |   | Discipline     | PIPING |
|   |   |   | Page: 57 OF 75 |        |

and contraction. Flexibility analysis of the piping systems shall be carried out. The Contractor shall provide any necessary pipe loops and supports.

#### **7.19 PIPING AT EQUIPMENT**

Piping at equipment shall be arranged so that the equipment can be removed easily by dismantling / adjusting the piping adjacent to the equipment without the need to dismantle any component of the equipment.

Equipment will not be used to anchor piping. Forces transmitted to equipment at tie-in points will be within the Equipment Supplier's recommended limits.

Piping connected to rotating equipment shall be designed and supported to minimize the transmission of vibrations from the machines. The Contractor shall carry out flexibility analysis of this pipe work to prevent exceeding, allowable nozzle loads as defined by the equipment manufacturer.

##### **7.19.1 PIPING AT HEAT EXCHANGERS**

Cooling water piping to shell & tube exchangers shall be arranged so that water will not drain from the outlet when water supply fails.

Exchanger piping shall be arranged so that the exchanger can be removed as one unit and so that the tube bundle can be pulled after disconnecting channel piping.

Piping connections to exchangers shall be designed and properly aligned to allow for hot & cold service and to limit the stress on exchanger nozzles to within allowable levels.

Filters shall be provided in lines to cooling fluid inlets.

##### **7.19.2 PIPING AT PUMPS**

Piping at pumps shall be designed and supported so that equipment can be dismantled or removed with a minimum number of temporary supports and without dismantling valves and piping other than the spool that connects to the pump. Clearances shall permit installation of blind flanges against block valves when the service is hazardous and the removal of pump rotating elements.

|             |                    |           |          |            |
|-------------|--------------------|-----------|----------|------------|
| FORMAT No.  | Ref. PROCEDURE No. | ISSUE No. | REV. No. | REV. DATE: |
| ODS/SOF/004 | ODS/SOP/023        | 01        | 00       | 21.07.2010 |

|   |   |   |                |        |
|---|---|---|----------------|--------|
|  | <b>Offshore Design Section<br/>Engineering Services<br/>ISO – 9001:2008</b> | <b>FUNCTIONAL<br/>SPECIFICATION FOR<br/>PIPING DESIGN</b> | Spec. No.      | 2004 A |
|   |   |   | Rev. No.       | 9      |
|   |   |   | Discipline     | PIPING |
|   |   |   | Page: 58 OF 75 |        |

Pump suction lines shall end with at least four diameters of straight pipe with the same nominal size as the suction flanges. If reducers are required on suction lines, they shall be eccentric and installed flat side up.

Recycle lines shall be provided to allow minimum flows required for pumps.

Pressure relief lines shall be provided for positive displacement pumps.

Valves shall be located as close as possible to the pump nozzles as practical. Isolation valves on pump suction lines shall be full-bore ball type. Isolation valves on discharge lines shall be located downstream of check valves.

Pump suction lines in which, vapour may be present shall be inclined downward towards the pumps with slopes of at least 1:50.

Strainers shall be provided in all pump suction lines. Permanent Y-type or basket strainers shall be provided for reciprocating and rotary pumps. The open area of strainers shall be at least 300% of the cross-sectional area of the pipe. The piping shall be arranged so that the filter or strainer element can be removed from the flanged joints without altering the piping, supports or pump alignment.

### 7.19.3 PIPING AT TURBINES

Air Inlet and Exhaust duct termination shall be positioned away from hazardous areas, and areas frequented by personnel or any open ended or filtered inlet ducts.

Fuel gas piping within the turbine enclosure shall be subject to strict control with respect to the number and type of flanged joints, fully welded being preferred. Flanged joints shall be provided only for connection to the equipment and for isolation and shut down valves.

### 7.19.4 PIPING AT DIESEL ENGINES

All piping connected to diesel engines shall be arranged in such a manner that adequate flexibility is maintained so as to effectively isolate the piping from any engine vibration. Piping shall not be routed directly over diesel engines.

Fuel lines shall not be run over exhaust piping or any location where leaks would cause fuel to impinge on to hot surfaces. Fuel lines shall incorporate local isolation valves.

|             |                    |           |          |            |
|-------------|--------------------|-----------|----------|------------|
| FORMAT No.  | Ref. PROCEDURE No. | ISSUE No. | REV. No. | REV. DATE: |
| ODS/SOF/004 | ODS/SOP/023        | 01        | 00       | 21.07.2010 |

|   |   |   |                       |               |
|---|---|---|-----------------------|---------------|
|  | <b>Offshore Design Section<br/>Engineering Services<br/>ISO – 9001:2008</b> | <b>FUNCTIONAL<br/>SPECIFICATION FOR<br/>PIPING DESIGN</b> | <b>Spec. No.</b>      | <b>2004 A</b> |
|   |   |   | <b>Rev. No.</b>       | <b>9</b>      |
|   |   |   | <b>Discipline</b>     | <b>PIPING</b> |
|   |   |   | <b>Page: 59 OF 75</b> |               |

The fuel oil header shall not be dead-ended.

Silencers, where installed in suction and discharge piping, shall be located as close as possible to the engine.

Air intake openings shall be located away from any hazardous area, face toward the prevailing wind direction and be in such a position as to limit the ingress of dust (e.g. salt crystals) and moisture.

#### **7.19.5 LAUNCHERS/RECEIVERS**

The “barrel” of the launchers/receivers shall be designed as per ASME-B31.4/31.8 (as applicable) using a design factor of 0.5 and “end closure” shall be designed as per ASME Section VIII, Division-I. Corrosion allowance as per applicable piping class & Material of construction for intended service should be considered in design of barrels. Weld efficiency factor shall be as per ASME-B31.4/31.8 (as applicable)

Launchers and receivers if installed horizontally shall have 5° slopes in the direction of flow. The internal diameter of launcher/ receiver shall be at least 2” higher than the pipe diameter.

Barrel length shall be at least 1-½ times and 2 ½ times as long as the pig selected/specified for launchers and receivers, respectively.

Eccentric type reducers shall be used on all horizontal launchers and receivers with flat side down while concentric type shall be used for vertical launchers/receivers. A spool piece of sufficient length of line pipe size shall be provided with launchers/receivers to ensure an effective seal before the pig enters the first block valve.

Scraper barrel shall be equipped with quick opening hinged type closures. Closures shall be rated for intended service and shall be provided with suitable interlock safety devices to prevent opening under pressure.

Launching/receiving stations shall be provided with an indicating device to detect and indicate the passage of a scraper or sphere.

Launchers and receivers of 600 mm (24 inch) OD and larger shall be equipped with loading/unloading trays to facilitate handling of heavy scrapers and spheres.

All branches from the barrel shall be taken by means of weldolets / sockolets.

|             |                    |           |          |            |
|-------------|--------------------|-----------|----------|------------|
| FORMAT No.  | Ref. PROCEDURE No. | ISSUE No. | REV. No. | REV. DATE: |
| ODS/SOF/004 | ODS/SOP/023        | 01        | 00       | 21.07.2010 |

|   |   |   |                |        |
|---|---|---|----------------|--------|
|  | <b>Offshore Design Section<br/>Engineering Services<br/>ISO – 9001:2008</b> | <b>FUNCTIONAL<br/>SPECIFICATION FOR<br/>PIPING DESIGN</b> | Spec. No.      | 2004 A |
|   |   |   | Rev. No.       | 9      |
|   |   |   | Discipline     | PIPING |
|   |   |   | Page: 60 OF 75 |        |

Suitable handling system for inserting/retracting the scraper/pig from the barrel shall be provided for each launcher/receiver. The system shall be self contained complete with handling and lifting devices.

#### 7.19.6 PIPING FOR OFFSHORE HOOK-UP

Hook-up piping shall be minimized as far as possible. Piping systems shall be designed so that the contractor in his fabrication yard can perform the maximum level of testing, mechanical completion and commissioning work.

#### 7.20 PIPING LAYOUT REQUIREMENTS

The layout of equipment and piping shall be based on following principles to provide neat and economical layout, allowing for easy supporting and adequate flexibility to meet equipment allowable nozzle load.

1. To locate all equipments identified on equipment list.
2. To comply with standards, regulations, codes, piping specifications and sound engineering practices.
3. To maximize safety of personnel, equipment and facilities.
4. To ensure operability & maintainability of equipment.
5. To provide means of escape & access for fire fighting.
6. To satisfy all requirements indicated in process documents (P&ID's)
7. To minimize shutdown duration.

All piping drawings shall be prepared to scale 1:331/3 with accuracy of +75mm and in metric system only. All piping for new platform shall be modeled using 3D modelling software as indicated elsewhere in bid package. Isometrics, Piping GADS, supports GAD's, material take off, interference checking, colour coding, structural module, instrument module, Design review model etc. shall be generated from the 3D model. The contractor shall make interim delivery of 3D model on the completion of each miles stone activity and final delivery on completion of the project. Contractor shall furnish the equipment lay out, safety route drawing, piping layout drawing (GAD), for company's review & approval. Contractor shall furnish one 3D modeling software terminal (dual type) along with dedicated modeling engineer at design center for online review of piping/equipment modeling to ONGC.

However, for modification jobs, piping plan shall be prepared in latest version of MICROSTATION/AUTOCAD.

|             |                    |           |          |            |
|-------------|--------------------|-----------|----------|------------|
| FORMAT No.  | Ref. PROCEDURE No. | ISSUE No. | REV. No. | REV. DATE: |
| ODS/SOF/004 | ODS/SOP/023        | 01        | 00       | 21.07.2010 |

|   |   |   |                       |               |
|---|---|---|-----------------------|---------------|
|  | <b>Offshore Design Section<br/>Engineering Services<br/>ISO – 9001:2008</b> | <b>FUNCTIONAL<br/>SPECIFICATION FOR<br/>PIPING DESIGN</b> | <b>Spec. No.</b>      | <b>2004 A</b> |
|   |   |   | <b>Rev. No.</b>       | <b>9</b>      |
|   |   |   | <b>Discipline</b>     | <b>PIPING</b> |
|   |   |   | <b>Page: 61 OF 75</b> |               |

All the information regarding instrument, equipment and line identification, direction of flow for lines, elevations and dimensions shall be clearly marked on piping plans. Efforts shall be made to provide maximum possible information including operating platforms, ladders, monorails, other material handling equipment, electrical cable and instrument trays, etc. shall be shown on piping plans to avoid reference to other drawings.

For any portion of a line where complete details i.e. dimensions, elevations etc. cannot be furnished in piping plan, a detailed isometric for that portion shall be indicated at a suitable place in the same GAD only. As far as possible all such details shall be shown together at a particular space provided for the purpose.

Piping plans shall show all lines indicated in Piping and Instrument diagrams. Separate line list as per format shall be prepared & submitted to the Company.

Pipe support standard drawings shall be submitted to company for review and separate pipe support drawings shall be generated by marking pipe supports on piping plans.

Piping arrangement drawings for skid-mounted equipment/vessels shall be furnished separately for review and approval. Piping arrangement inside skids need not be shown on piping GAD's.

All distribution/collection headers shall have their dead ends blind flange. Piping Isometrics shall be prepared for all lines and furnished for information.

All the future lines shown in P&ID's shall be routed and shown as chain dotted on GAD's with full details indicating dimensions, line numbers, etc. All future/spare piping connections envisaged in the existing scope of work will be terminated with blind flange. Requirement of spectacle blind and valve at the termination shall be provided if indicated in P&ID. The following shall be the minimum to be shown on the piping drawings wherever applicable:

Line Number

Instrument/specialties/equipment Tag Number

Instrument Connections

Orientation of North arrow

Battery/Area limit as per area division/skid

Title block and drawing nos. as per area division/drawing schedule

|             |                    |           |          |            |
|-------------|--------------------|-----------|----------|------------|
| FORMAT No.  | Ref. PROCEDURE No. | ISSUE No. | REV. No. | REV. DATE: |
| ODS/SOF/004 | ODS/SOP/023        | 01        | 00       | 21.07.2010 |

|   |   |   |                |        |
|---|---|---|----------------|--------|
|  | <b>Offshore Design Section<br/>Engineering Services<br/>ISO – 9001:2008</b> | <b>FUNCTIONAL<br/>SPECIFICATION FOR<br/>PIPING DESIGN</b> | Spec. No.      | 2004 A |
|   |   |   | Rev. No.       | 9      |
|   |   |   | Discipline     | PIPING |
|   |   |   | Page: 62 OF 75 |        |

Key plan

Reference drawings

Legends and Notes

Table of Nozzle data orientation and location

Match line, continuation drawing number

Location of equipment as per equipment layout; P&ID's special notes.

Dimension & equipment elevations with reference to data sheets.

## 8. PROTECTIVE COATINGS & INSULATION

### Painting and Protective Coatings:

Painting, protective coatings and the procedures used for the preparation of surfaces shall be specified in the Project Specification for Protective Coatings spec 2005.

Flanges shall be painted on the flange edges, inside bolt-holes, and up to the gasket surface.

### Insulation:

Piping shall be insulated where indicated on drawings. The piping to be insulated shall be grit blasted and painted as per FS 2005 except for finish coat and only then, insulation to be applied as per the Project Specification for Insulation of Piping and Equipment spec 2006.

## 9. PIPING SPECIFICATION INDEX

DESIGN CODE: ASME B31.3

| SN | CODE | RATING | MATERIAL | SERVICE                     |
|----|------|--------|----------|-----------------------------|
| 1  | A1   | 150#   | CS       | NOTE-1                      |
| 2  | B1   | 300#   | CS       | NOTE-1                      |
| 3  | D1   | 600#   | CS       | NOTE-1                      |
| 4  | E1   | 900#   | CS       | NOTE-1                      |
| 5  | A2   | 150#   | CS       | Glycol                      |
| 6  | B2   | 300#   | CS       | Glycol                      |
| 7  | D2   | 600#   | CS       | Glycol                      |
| 8  | E2   | 900#   | CS       | Glycol                      |
| 9  | A1N  | 150#   | CS-NACE  | Hydrocarbon liquid & vapour |

|             |                    |           |          |            |
|-------------|--------------------|-----------|----------|------------|
| FORMAT No.  | Ref. PROCEDURE No. | ISSUE No. | REV. No. | REV. DATE: |
| ODS/SOF/004 | ODS/SOP/023        | 01        | 00       | 21.07.2010 |





**Offshore Design Section  
Engineering Services  
ISO – 9001:2008**

**FUNCTIONAL  
SPECIFICATION FOR  
PIPING DESIGN**

**Spec. No. 2004 A**  
**Rev. No. 9**  
**Discipline PIPING**  
**Page: 63 OF 75**

|    |      |          |                   |                              |
|----|------|----------|-------------------|------------------------------|
| 10 | B1N  | 300#     | CS-NACE           | Hydrocarbon liquid & vapour  |
| 11 | D1N  | 600#     | CS-NACE           | Hydrocarbon liquid & vapour  |
| 12 | E1N  | 900#     | CS-NACE           | Hydrocarbon liquid & vapour  |
| 13 | F1N  | 1500#    | CS-NACE           | Hydrocarbon liquid & vapour  |
| 14 | G1N  | 2500#    | CS-NACE           | Hydrocarbon liquid & vapour  |
| 15 | XG1  | API-5000 | CS                | Hydrocarbon liquid & vapour  |
| 16 | XG1N | API-5000 | CS-NACE           | Hydrocarbon liquid & vapour  |
| 17 | A3   | 150#     | CS-Galv./SS       | Instrument Air               |
| 18 | B3   | 300#     | CS-Galv./SS       | Instrument Air               |
| 19 | D3   | 600#     | CS-Galv./SS       | Instrument Air               |
| 20 | A4   | 150#     | CS-Galvanized     | Potable Water-Non Drinking   |
| 21 | A5   | 150#     | 90/10 Cu-Ni       | Fire water/Raw sea water     |
| 22 | A6   | 150#     | SS                | Exhaust                      |
| 23 | A8   | 150#     | CS (GALVANISED)   | Overboard line               |
| 24 | A9   | 150#     | SS-316            | Lube oil & service oil       |
| 25 | B9   | 300#     | SS-316            | Lube oil & service oil       |
| 26 | D9   | 600#     | SS-316            | Lube oil & service oil       |
| 27 | E9   | 900#     | SS-316            | Lube oil & service oil       |
| 28 | A10  | 150#     | SS-316L-NACE      | Hydrocarbon liquid & vapour  |
| 29 | B10  | 300#     | SS-316L-NACE      | Hydrocarbon liquid & vapour  |
| 30 | D10  | 600#     | SS-316L-NACE      | Hydrocarbon liquid & vapour  |
| 31 | E10  | 900#     | SS-316L-NACE      | Hydrocarbon liquid & vapour  |
| 32 | F10  | 2500#    | SS-316L-NACE      | Hydrocarbon liquid & vapour  |
| 33 | A12  | 150#     | Titanium          | Ferric Chloride/Chemical     |
| 34 | A13  | 150#     | COPPER            | Potable water- Drinking      |
| 35 | A1LN | 150#     | INCOLOY 825       | Hydrocarbon liquid & vapour  |
| 36 | A22  | 150#     | SS-316L           | Corrosion Inhibitor/Chemical |
| 37 | B22  | 300#     | SS-316L           | Corrosion Inhibitor/Chemical |
| 38 | D22  | 600#     | SS-316L           | Corrosion Inhibitor/Chemical |
| 39 | E22  | 900#     | SS-316L           | Corrosion Inhibitor/Chemical |
| 40 | A23  | 150#     | DSS (UNS S 32205) | Hydrocarbon liquid & vapour  |
| 41 | B23  | 300#     | DSS (UNS S 32205) | Hydrocarbon liquid & vapour  |
| 42 | D23  | 600#     | DSS (UNS S 32205) | Hydrocarbon liquid & vapour  |
| 43 | E23  | 900#     | DSS (UNS S 32205) | Hydrocarbon liquid & vapour  |





**Offshore Design Section  
Engineering Services  
ISO – 9001:2008**

**FUNCTIONAL  
SPECIFICATION FOR  
PIPING DESIGN**

**Spec. No. 2004 A  
Rev. No. 9  
Discipline PIPING  
Page: 64 OF 75**

|    |       |          |                   |   |
|----|-------|----------|-------------------|---|
| 44 | F23   | 1500#    | DSS (UNS S 32205) | Hydrocarbon liquid & vapour   |
| 45 | G23   | 2500#    | DSS (UNS S 32205) | Hydrocarbon liquid & vapour   |
| 46 | A15   | 150#     | INCOLOY 825       | Hydrocarbon liquid & vapour   |
| 47 | B15   | 300#     | INCOLOY 825       | Hydrocarbon liquid & vapour   |
| 48 | D15   | 600#     | INCOLOY 825       | Hydrocarbon liquid & vapour   |
| 49 | E15   | 900#     | INCOLOY 825       | Hydrocarbon liquid & vapour   |
| 50 | XG15  | API 5000 | INCOLOY 825       | Hydrocarbon liquid & vapour   |
| 51 | XH15  | API 5000 | INCOLOY 825       | Hydrocarbon liquid & vapour   |
| 52 | A15A  | 150#     | INCONEL 625       | Hydrocarbon liquid & vapour   |
| 53 | B15A  | 300#     | INCONEL 625       | Hydrocarbon liquid & vapour   |
| 54 | D15A  | 600#     | INCONEL 625       | Hydrocarbon liquid & vapour   |
| 55 | E15A  | 900#     | INCONEL 625       | Hydrocarbon liquid & vapour   |
| 56 | PE1   | 900#     | CS                | Hydrocarbon liquid & vapour   |
| 57 | PB1N  | 300#     | CS-NACE           | Hydrocarbon liquid & vapour   |
| 58 | PD1N  | 600#     | CS-NACE           | Hydrocarbon liquid & vapour   |
| 59 | PE1N  | 900#     | CS-NACE           | Hydrocarbon liquid & vapour   |
| 60 | A7    | 150#     | CPVC              | Sodium hypochlorite   |
| 61 | A3S   | 150#     | GRE               | Fire Water (raw)  |
| 62 | A3S-1 | 150#     | GRE               | Fire Water-Raw sea water (Dry)  |
| 63 | A5S   | 150#     | GRE               | Produced water, sewage water/Gray Services, Cooling water, Open drain, Utility water, |
| 64 | A11   | 150#     | DSS (UNS S 31803) | Hydrocarbon liquid & vapour   |
| 65 | B11   | 300#     | DSS (UNS S 31803) | Hydrocarbon liquid & vapour   |
| 66 | D11   | 600#     | DSS (UNS S 31803) | Hydrocarbon liquid & vapour   |
| 67 | E11   | 900#     | DSS (UNS S 31803) | Hydrocarbon liquid & vapour   |
| 68 | F11   | 1500#    | DSS (UNS S 31803) | Hydrocarbon liquid & vapour   |
| 69 | A16   | 150#     | SDSS              | Hydrocarbon liquid & vapour   |
| 70 | B16   | 300#     | SDSS              | Hydrocarbon liquid & vapour   |
| 71 | D16   | 600#     | SDSS              | Hydrocarbon liquid & vapour   |
| 72 | E16   | 900#     | SDSS              | Hydrocarbon liquid & vapour   |
| 73 | A14   | 150#     | PVC               | Sewage Water  |

|                           |                                   |                 |                |                          |
|---------------------------|-----------------------------------|-----------------|----------------|--------------------------|
| FORMAT No.<br>ODS/SOF/004 | Ref. PROCEDURE No.<br>ODS/SOP/023 | ISSUE No.<br>01 | REV. No.<br>00 | REV. DATE:<br>21.07.2010 |
|---------------------------|-----------------------------------|-----------------|----------------|--------------------------|

|   |   |   |                |        |
|---|---|---|----------------|--------|
|  | <b>Offshore Design Section<br/>Engineering Services<br/>ISO – 9001:2008</b> | <b>FUNCTIONAL<br/>SPECIFICATION FOR<br/>PIPING DESIGN</b> | Spec. No.      | 2004 A |
|   |   |   | Rev. No.       | 9      |
|   |   |   | Discipline     | PIPING |
|   |   |   | Page: 65 OF 75 |        |

|    |      |       |             |                             |
|----|------|-------|-------------|-----------------------------|
| 74 | F1   | 1500# | CS          | Note-1                      |
| 75 | F10  | 1500# | SS-316L     | Hydrocarbon liquid & vapour |
| 76 | F 15 | 1500# | Incoloy-825 | Hydrocarbon liquid & vapour |

**NOTES:**

1. This standard is used for injection water, vent gas, diesel fuel, process drain water, process drain hydrocarbon, blow down, nitrogen services. However, MOC shall be as per P & ID.
2. Corrosion allowance is indicated in Spec.2004A Clause no.5.3.
3. Material description & special requirements are listed in piping design criteria.
4. Contractor shall prepare the piping class data sheet and shall furnish to Company for review & approval.

|             |                    |           |          |            |
|-------------|--------------------|-----------|----------|------------|
| FORMAT No.  | Ref. PROCEDURE No. | ISSUE No. | REV. No. | REV. DATE: |
| ODS/SOF/004 | ODS/SOP/023        | 01        | 00       | 21.07.2010 |

|   |   |   |                       |               |
|---|---|---|-----------------------|---------------|
|  | <b>Offshore Design Section<br/>Engineering Services<br/>ISO – 9001:2008</b> | <b>FUNCTIONAL<br/>SPECIFICATION FOR<br/>PIPING DESIGN</b> | <b>Spec. No.</b>      | <b>2004 A</b> |
|   |   |   | <b>Rev. No.</b>       | <b>9</b>      |
|   |   |   | <b>Discipline</b>     | <b>PIPING</b> |
|   |   |   | <b>Page: 66 OF 75</b> |               |

**GENERAL REQUIREMENTS**

|                   |                           |                  |                 |                   |
|-------------------|---------------------------|------------------|-----------------|-------------------|
| <b>FORMAT No.</b> | <b>Ref. PROCEDURE No.</b> | <b>ISSUE No.</b> | <b>REV. No.</b> | <b>REV. DATE:</b> |
| ODS/SOF/004       | ODS/SOP/023               | 01               | 00              | 21.07.2010        |

|   |   |   |                |        |
|---|---|---|----------------|--------|
|  | <b>Offshore Design Section<br/>Engineering Services<br/>ISO – 9001:2008</b> | <b>FUNCTIONAL<br/>SPECIFICATION FOR<br/>PIPING DESIGN</b> | Spec. No.      | 2004 A |
|   |   |   | Rev. No.       | 9      |
|   |   |   | Discipline     | PIPING |
|   |   |   | Page: 67 OF 75 |        |

## 10 GENERAL REQUIREMENTS

### 10.1 PRE-QUALIFICATION CRITERIA AND TESTS FOR MANUFACTURERS (NEW VENDORS)

Suggested vendor list is listed elsewhere in bid package. The vendors who are not listed in suggested vendor list shall be required to furnish the following documents for Company's review for the purpose of pre-qualification.

1. The item/equipment should be in satisfactory service in offshore oil & gas operations for a minimum period of 2 years. This shall be supported with performance feedback from the end-users (The firm using the item/equipment for its offshore oil and gas operations) or repeat purchase orders from the same end user with a minimum time gap of two years of delivery.
2. Catalogue and Drawings for the product.
3. The name(s) & location of Manufacturer/Forging source/Raw material source (Mill) etc.
4. The manufacturer shall be qualified based on results of these tests & information furnished and Company's decision in this regard shall be final and binding on the bidder.
5. The list of manufacturing facilities and quality control equipment.
6. The tests certificates specified in clause 5 shall be conducted by the mill/supplier for the purpose of initial qualification. The test results shall be submitted to the company for approval prior to placement of order. In case the supplier has already carried out all these tests and the test results are certified by a recognized independent inspection agency (viz. Lloyds, BV, DNV etc.) all such test reports/certificates/document shall be forwarded to the company for review and approval. The Company shall assess the capability of the supplier upon scrutiny and verification of the documents submitted. Company's decisions in this regard shall be final and binding on contractor.
7. Qualification for NACE material shall be made product wise, material wise, type of product wise (Seamless or welded), type of valve wise irrespective of thickness/size/type of fittings/pressure rating. Following test certificates/documents to be required:
  1. Steel making procedure from raw material supplier including specific details and confirmation to requirements as per relevant codes & standards.

|             |                    |           |          |            |
|-------------|--------------------|-----------|----------|------------|
| FORMAT No.  | Ref. PROCEDURE No. | ISSUE No. | REV. No. | REV. DATE: |
| ODS/SOF/004 | ODS/SOP/023        | 01        | 00       | 21.07.2010 |

|   |   |   |                       |               |
|---|---|---|-----------------------|---------------|
|  | <b>Offshore Design Section<br/>Engineering Services<br/>ISO – 9001:2008</b> | <b>FUNCTIONAL<br/>SPECIFICATION FOR<br/>PIPING DESIGN</b> | <b>Spec. No.</b>      | <b>2004 A</b> |
|   |   |   | <b>Rev. No.</b>       | <b>9</b>      |
|   |   |   | <b>Discipline</b>     | <b>PIPING</b> |
|   |   |   | <b>Page: 68 OF 75</b> |               |

2. Following test certificates, duly witnessed and certified by any of the Company approved third party inspection agency (as listed in clause 10.2) as per relevant codes & standards and requirements listed below, shall be furnished for Company's approval.
  - 2.1 Chemical composition of heat & finished product. This shall meet the requirements of chemical composition indicated in relevant codes & standards.
  - 2.2 Mechanical Tests on heat & finished product as per relevant codes & standards.
  - 2.3 Hardness test on the heat & finished product as per relevant codes & standards.
  - 2.4 Corrosion tests (HIC, SSCC & inclusion count check) on the finished product of past supplies as per relevant codes & standards. The test shall be applicable to all materials for sour service application (viz: CS (NACE), DSS, INCOLOY CLAD MATERIAL).
  - 2.5 Other test for DSS & INCOLOY clad material: Other test as indicated in clause 5.7 & 5.8 (sour service requirements for DSS & INCOLOY CLADDING MATERIAL)
  - 2.6 The requirements stated in relevant codes & standards shall also be fully complied in order to meet the qualification of the product on each heat & finished product.
3. Each certificate shall indicate product name, heat number, raw material source/forge shop/cast shop/manufacturer (as applicable) and shall clearly indicate witnessed and certified with proper signature and seal of the inspecting agency. Any certificate not meeting these requirements shall be rejected.
4. Over and above these certificates, a certificate from the Company approved third party inspection agency shall be furnished containing the following:
  - 4.1 Scope to clarify the extent of involvement of the Inspection Agency for the job order.
  - 4.2 Certification that the sample for the test was taken from the finished product (e.g. pipe, fittings, flange, valve or plate etc.) manufactured from the heat indicated in the certificates and indicate the names of raw material source (Mill)/forge shop cast shop/manufacturer (as applicable) employed in manufacture of the finished product.
5. Quality Assurance Manual shall be furnished for Company's review, which should include the schemes for raw material quality assurance, on line process quality assurance,

|             |                    |           |          |            |
|-------------|--------------------|-----------|----------|------------|
| FORMAT No.  | Ref. PROCEDURE No. | ISSUE No. | REV. No. | REV. DATE: |
| ODS/SOF/004 | ODS/SOP/023        | 01        | 00       | 21.07.2010 |

|   |   |   |                       |               |
|---|---|---|-----------------------|---------------|
|  | <b>Offshore Design Section<br/>Engineering Services<br/>ISO – 9001:2008</b> | <b>FUNCTIONAL<br/>SPECIFICATION FOR<br/>PIPING DESIGN</b> | <b>Spec. No.</b>      | <b>2004 A</b> |
|   |   |   | <b>Rev. No.</b>       | <b>9</b>      |
|   |   |   | <b>Discipline</b>     | <b>PIPING</b> |
|   |   |   | <b>Page: 69 OF 75</b> |               |

product quality assurance, storage and traceability of products, personal quality assurance and quality control procedures.

6. Bidder/manufacturer shall note that for manufacturing of the quoted items, the same sources (i.e. forging source, raw material source, manufacturer etc.) shall be utilized which was employed to manufacture the product on which prequalification tests are carried and approved. Subsequent to qualification, a change of manufacturer/forging source/raw material source (mill) shall not be permitted. In the event that the manufacturer desires to effect any change in any of the above, the manufacturer shall seek fresh qualification as indicated above.

## 10.2 SUGGESTED THIRD PARTY INSPECTION AGENCIES

M/s Lloyd registers of Shipping (LRS)

M/s Bureau Veritas (BV)

M/s Det Norske Veritas (DNV)

M/s Certification Engineers India ltd (CEIL)

M/s Societe Generate De Surveillance (SGS)

M/s Moody's international

M/s TUV International

M/s ABS

If any of the party is nominated or specified for the job work, then supplier must follow the Company's Requirements.

## 10.3 QUALITY ASSURANCE

The manufacturer, supplier & his sub supplier shall operate a quality system satisfying the applicable provisions of ISO 9000 (SERIES) or Company agreed equivalent standard, commensurate with the goods & services provided.

## 10.4 SAFETY PROVISIONS

It is the intent of the company that operational hazards to be reduces to a minimum. Contractor shall use sound engineering judgments to complete an installation that will perform the required process functions without compromising this aim. The platform shall be designed in accordance with API RP 14C, Recommended practice for analysis, design, installation & testing of basic surface safety system on the offshore production platform (latest edition). The contractor shall also follow the safety provisions indicated elsewhere in bid package.

|             |                    |           |          |            |
|-------------|--------------------|-----------|----------|------------|
| FORMAT No.  | Ref. PROCEDURE No. | ISSUE No. | REV. No. | REV. DATE: |
| ODS/SOF/004 | ODS/SOP/023        | 01        | 00       | 21.07.2010 |

|   |   |   |                |        |
|---|---|---|----------------|--------|
|  | <b>Offshore Design Section<br/>Engineering Services<br/>ISO – 9001:2008</b> | <b>FUNCTIONAL<br/>SPECIFICATION FOR<br/>PIPING DESIGN</b> | Spec. No.      | 2004 A |
|   |   |   | Rev. No.       | 9      |
|   |   |   | Discipline     | PIPING |
|   |   |   | Page: 70 OF 75 |        |

### 10.5 RECEIPT & STORAGE

The contractor shall develop the comprehensive plan for receipt, storage and release of all equipments released in contractor's care including item supplied by others or free issued by the company. This plan shall provide means to immediately establish the status & locations of any items, which has been issued to the contractor.

The contractor shall be fully responsible for equipment issued & shall provide secure facilities to provide a storage environment, which shall protect the equipment to the vendor's requirement. Any equipment damaged after issue to the contractor shall be repaired, reinstated or replaced by the contractor at company's decision.

### 10.6 SPARES

Manufacturer shall recommend and provide the spares required for start up and commissioning for all specialties/ vessels or any other item.

Manufacturer shall recommend and provide the spares needed for one-year operation and maintenance for all specialties.

### 10.7 WARRANTIES

- A. The contractor shall agree to warrant all the pipes, fittings, flanges, gaskets, bolting, valves, specialties & vessels furnished by him to be free from defects in design, material, & workmanship.
- B. The contractor shall agree to warrant all the pipes, fittings, flanges, gaskets, bolting, valves, specialties & vessels furnished by him will satisfy the requirements of intended use and to be suitable for application.
- C. The contractor shall agree to warrant all the pipes, fittings, flanges, gaskets, bolting, valves, specialties & vessels furnished by him for any repair or replace under present tender, which proves to be defective within a period of 12 months from date of completion and handing over to the operation group of company.
- D. The contractor shall be solely responsible for obtaining manufacture's performance warranty for all pipes, fittings, flanges, gaskets, bolting, valves, specialties & vessels purchased by him and shall produce the warranty certificate to the company.
- E. Where materials of construction or the application of items recommended by contractor do not confirm with the manufacture's recommendation, the contractor shall assume the

|             |                    |           |          |            |
|-------------|--------------------|-----------|----------|------------|
| FORMAT No.  | Ref. PROCEDURE No. | ISSUE No. | REV. No. | REV. DATE: |
| ODS/SOF/004 | ODS/SOP/023        | 01        | 00       | 21.07.2010 |

|   |   |   |                       |               |
|---|---|---|-----------------------|---------------|
|  | <b>Offshore Design Section<br/>Engineering Services<br/>ISO – 9001:2008</b> | <b>FUNCTIONAL<br/>SPECIFICATION FOR<br/>PIPING DESIGN</b> | <b>Spec. No.</b>      | <b>2004 A</b> |
|   |   |   | <b>Rev. No.</b>       | <b>9</b>      |
|   |   |   | <b>Discipline</b>     | <b>PIPING</b> |
|   |   |   | <b>Page: 71 OF 75</b> |               |

equivalent of manufacturer's warranty and in the event of malfunction or damage resulting from this misapplication, the contractor will not be released from this warranty.

#### **10.8 DOCUMENTATION**

The contractor shall provide one set of soft copies on CD/Hard disc for approved drawings/ documents & materials for all pipes, fittings, valves, flanges, piping specialties & vessels documents to the piping engineer designated for the project in additions to the company's project requirement. Further, hardcopy any of the above documents shall be submitted as and when required by company. The contractor shall submit the "ORIGINALS" on demand by company to verify the duplicate (Xerox) copies for test certificates review. On placement of order, the manufacturer/mill shall carry out all the production tests as indicated in relevant clauses of this document and submit reports to Company for review and approval. The test reports shall be submitted to Company before dispatch of material from the mill. The approved certificates from company shall be submitted to the piping engineer of company at fabrication site.

|                   |                           |                  |                 |                   |
|-------------------|---------------------------|------------------|-----------------|-------------------|
| <b>FORMAT No.</b> | <b>Ref. PROCEDURE No.</b> | <b>ISSUE No.</b> | <b>REV. No.</b> | <b>REV. DATE:</b> |
| ODS/SOF/004       | ODS/SOP/023               | 01               | 00              | 21.07.2010        |



|   |   |   |                       |               |
|---|---|---|-----------------------|---------------|
|  | <b>Offshore Design Section<br/>Engineering Services<br/>ISO – 9001:2008</b> | <b>FUNCTIONAL<br/>SPECIFICATION FOR<br/>PIPING DESIGN</b> | <b>Spec. No.</b>      | <b>2004 A</b> |
|   |   |   | <b>Rev. No.</b>       | <b>9</b>      |
|   |   |   | <b>Discipline</b>     | <b>PIPING</b> |
|   |   |   | <b>Page: 72 OF 75</b> |               |

## GLASS REINFORCED EPOXY

## Annexure – 1

### 1.1 Scope

This specification contains minimum requirements for design, manufacture, qualification, quality control, testing, site fabrication, installation and certification of (GRE) composite material piping for facilities on offshore platforms.

### 1.2 Design / Operating Data

The design / operating data such as pressure, temperature, flow rate, structural load, etc. shall be provided by the user section or the selection / design of GRE pipelines for the relevant services.

### 1.3 Design & Manufacture of GRE piping

- i. The piping and fittings shall be manufactured with epoxy resin as per ASTM D 2996 with thickness to suit the design pressure, taking into account the hydrostatic test pressure at the time of installation i.e. 1.5 times the design pressure. The manufacturer shall give full details of this methodology of arriving at the quoted thickness, including lower confidence limit static (LCLs). The hydrostatic design stress shall be calculated as : 0.5 X LCLs. However, all the components of piping system shall have minimum 3.0 mm reinforced wall thickness. Sea water piping shall be designed for a nominal velocity of 5 m/s. The fire water piping system shall also be designed for blast over pressures.
- ii. The piping and fittings shall be manufactured by using epoxy resin and the structural glass fiber shall be E-glass. The fittings shall be manufactured by the same piping manufacturer and compatible adhesives shall also be supplied by the manufacturer.
- iii. Inner surface of piping and fittings shall have at least 0.5 mm thick reinforced resin rich liner with C-glass or synthetic fibres and with resin content at least 65%.
- iv. For UV protection, UV stabilizer will be added in the resin used for manufacturing GRE piping.
- v. Filler shall not be used in the resin during manufacturing process of GRE piping.
- vi. The piping and fittings shall be joined by the bell & spigot joint using adhesives or butt and wrap joint.
- vii. Flanges shall be heavy-duty filament wound as per ASTM D 4024 and ASME B 16.5.
- viii. Stress analysis shall be carried out for estimation of stresses in circumferential and longitudinal direction. Stress analysis shall include, but not limited to, all anchors, guides and supports. The piping system shall be designed in such a way to minimize stresses resulting from surge or transient pressures on account of valve closures or other condition resulting in change in fluid velocity and those resulting from movements such as expansion and contraction from pressure and temperature differences.

|             |                    |           |          |            |
|-------------|--------------------|-----------|----------|------------|
| FORMAT No.  | Ref. PROCEDURE No. | ISSUE No. | REV. No. | REV. DATE: |
| ODS/SOF/004 | ODS/SOP/023        | 01        | 00       | 21.07.2010 |

|   |   |                       |               |
|---|---|-----------------------|---------------|
|  <b>Offshore Design Section<br/>Engineering Services<br/>ISO – 9001:2008</b> | <b>FUNCTIONAL<br/>SPECIFICATION FOR<br/>PIPING DESIGN</b> | <b>Spec. No.</b>      | <b>2004 A</b> |
|   |   | <b>Rev. No.</b>       | <b>9</b>      |
|   |   | <b>Discipline</b>     | <b>PIPING</b> |
|   |   | <b>Page: 73 OF 75</b> |               |

- ix. Epoxy resins and additives used in the manufacture of potable water piping and fittings shall satisfy the requirements of FDA / NSF / WHO or other Indian regulatory Authorities for potability of water.

#### **1.4 Qualification & Quality Control of GRE Piping**

- i. The piping and fittings shall be qualified for pressure rating as per ASTM D 2992. Manufacturer shall enclose the test report and calculations.
- ii. For quality control, the short term hydrostatic pressure (STHP) of at least one sample per production lot shall be determined in accordance with ASTM D 1599 at standard laboratory temperature and the value should not be less than mean of STHP for the representative product established in the qualification test. The test report for qualification and quality control shall be certified by reputed certifying agencies like LRS, DNV, BV, ABS, TUV, Vetco Tuboscope.
- iii. Test certificates shall be provided for use of GRE piping, fittings, O-rings, gaskets and adhesives in potable water applications as per FDA /NSF / SHO or other Indian regulatory Authorities.
- iv. The fire water piping shall qualify endurance testing requirements as per level 3 requirements of IMO Resolution A 753(18) or as latest version of ISO standard 14692-2 for glass reinforced plastics piping in Petroleum and Natural Gas Industries.
- v. The GRE piping including all its components for dry portion of fire water system shall be designed such that line is capable of withstanding initially fire up to maximum of 5 minutes by jet fire, followed by flowing water from deluge system by which time the line gets filled with water due to actuation of deluge system. The heat flux of impinging flame shall be decided based upon relevant codes and standard.
- vi. The GRE piping shall conform to the fire endurance tests for dry condition in accordance with appendix I of IMO resolution A. 753 (18), 1993.

#### **1.5 Fabrication & Installation of GRE Piping**

- i. The piping and fittings shall be fabricated and installed as per UKOOA's "Specifications and Recommended Practice for the use of GRP Piping Offshore", March 1994, ISO 14692-1/2/3/4(Petroleum and Natural Gas Industries-Glass Reinforced Plastic Piping).
- ii. All GRE/GRP piping shall be fabricated and installed under the supervision of manufacturer/Manufacturer's representative certified by the manufacturer.
- iii. All GRE piping shall be conductive and grounded through metallic parts in the system such as valves, pumps, etc. and as per manufacturer's recommendations.

|             |                    |           |          |            |
|-------------|--------------------|-----------|----------|------------|
| FORMAT No.  | Ref. PROCEDURE No. | ISSUE No. | REV. No. | REV. DATE: |
| ODS/SOF/004 | ODS/SOP/023        | 01        | 00       | 21.07.2010 |

|   |   |   |                |        |
|---|---|---|----------------|--------|
|  | <b>Offshore Design Section<br/>Engineering Services<br/>ISO – 9001:2008</b> | <b>FUNCTIONAL<br/>SPECIFICATION FOR<br/>PIPING DESIGN</b> | Spec. No.      | 2004 A |
|   |   |   | Rev. No.       | 9      |
|   |   |   | Discipline     | PIPING |
|   |   |   | Page: 74 OF 75 |        |

- iv. GRE piping & components which remain dry during normal operation of a platform; such as drain lines shall be applied intumescent coating for fire insulation / protection as per applicable standard/application. While deciding type of intumescent coating toxicity of the smoke shall also be considered. Fire insulation material should be such a type that does not require the use of reinforcing mesh.

### 1.6 Certification Requirements of GRE Piping.

Offered product shall have valid class and type certificate from reputed certifying agencies like LRS, DNV, BV, ABS

### 1.7 List of Codes & Standards for (GRE) Composite Material Piping

|                |  |
|----------------|--|
| ASTM D 2992    | Standard Practice for Obtaining Hydrostatic or Pressure Design Basis for “Fiberglass” (Glass-Fiber-Reinforced Thermosetting-Resin) Pipe and Fittings.  |
| ASTM D 2996    | Standard Specification for Filament-Wound “Fiberglass” (Glass-Fiber-Reinforced Thermosetting Resin) Pipe   |
| ASTM D 2105    | Standard Test Method for Longitudinal Tensile Properties of “Fiberglass” (Glass Fiber Reinforced Thermosetting Resin) Pipe and Tube  |
| ASTM D 2143    | Standard Test Method for Cyclic Pressure Strength of Reinforced, Thermosetting Plastic Pipe.   |
| ASTM D 2517    | Standard Specification for Reinforced Epoxy Resin Gas Pressure Pipe and Fittings.  |
| ASTM D 2997    | Standard Specification for Centrifugally Cast “Fiberglass” (Glass-Fiber-Reinforced Thermosetting-Resin) Pipe details the specifications for machine made glass fiber reinforced thermosetting resin pressure pipe. |
| ASTM C 581     | Standard Practice for Determining Chemical Resistance to Thermosetting Resins.   |
| ASTM D 570     | Test Method for Water Absorption of Plastics.  |
| ASTM D 2290    | Standard Test Method for Apparent Hoop Tensile Strength of Plastic or Reinforced Plastic Pipe by Split Disk Method.  |
| ASTM D 2412    | Standard Test Method for Determination of External Loading Characteristics of plastic pipe by parallel – plate Loading sets forth methods.   |
| ASTM D 2924    | Standard Test Method for External Pressure Resistance of “Fiberglass” (Glass Fiber Reinforced Thermosetting Resin) Pipe.   |
| ASTM D 5685-01 | Standard Specification for “Fiberglass” (Glass Fiber Reinforced Thermosetting Resin) Pressure Pipe Fittings.   |
| ASTM D 638     | Standard Test Method for Tensile Properties of Plastics.   |
| ASTM D 1598    | Standard Test Method for Time to Failure of Plastic Pipe Under Constant Internal Pressure.   |
| ASTM D 1599    | Standard Test Method for Resistance to short time Hydraulic  |

|             |                    |           |          |            |
|-------------|--------------------|-----------|----------|------------|
| FORMAT No.  | Ref. PROCEDURE No. | ISSUE No. | REV. No. | REV. DATE: |
| ODS/SOF/004 | ODS/SOP/023        | 01        | 00       | 21.07.2010 |

|   |   |   |                |        |
|---|---|---|----------------|--------|
|  | <b>Offshore Design Section<br/>Engineering Services<br/>ISO – 9001:2008</b> | <b>FUNCTIONAL<br/>SPECIFICATION FOR<br/>PIPING DESIGN</b> | Spec. No.      | 2004 A |
|   |   |   | Rev. No.       | 9      |
|   |   |   | Discipline     | PIPING |
|   |   |   | Page: 75 OF 75 |        |

|                     |   |
|---------------------|---|
|                     | Pressure of Plastic Pipe, Tubing and Fittings.  |
| UKOOA               | Specification and Recommended Practice for the Use of FRP Piping.   |
| API Spec 15 LR      | Low pressure fiberglass line pipe.  |
| API Spec 15 HR      | High pressure fiberglass line pipe.   |
| API RP 15 TL 4      | Recommended Practice for Care and Use of Fiberglass Tubulars.   |
| ASME B 16.5         | Pipes, Flanges and Flange Fittings.   |
| ASME B 31.3         | Process Piping.   |
| ASME BPVC Section X | Boiler & Pressure Vessel Code.  |
| ASTM D 695          | Test Method for Compressive Properties of Rigid Plastic.  |
| ASTM D 696          | Test Method for Coefficient of Linear Thermal Expansion of Plastic.   |
| AWWA C 950          | Standard for Fiberglass Pressure Pipe.  |
| BS 5480             | Specification for Glass reinforced plastic (GRP) pipes, joints and fittings for use for water supply or sewerage. |
| BS 6464             | Specification of reinforced plastic pipes, fittings and joints for process plants.                                |
| ASTM D 648          | Test for deflection temperature of plastics under flexural loads.   |
| ASTM D 2310         | Classification for machine made reinforced thermosetting resin pipe.  |
| ASTM D 1652         | Test Method for epoxy content of epoxy resins.  |
| ASTM D 2343         | Test Method for Tensile Properties of Glass Fiber Strands, Yarn and Roving use in Reinforced plastics.            |
| ASTM D 2344         | Apparent Inter Laminar Shear Strength of Parallel Fiber Composites by Short Beam Method.                          |
| ASTM D 2393         | Standard Test Method for Viscosity of Epoxy Resin and Related Components.   |
| ASTM D 2471         | Standard of Test Method for Gel Time and Peak Exothermic Temperature of Reacting Thermosetting Resin.             |
| ASTM D 2563         | Standard Test Method for Classifying Visual Defects in Glass Reinforced Plastics Laminate Parts.                  |
| ASTM D 2583         | Standard Test Method for Indentation Hardness of Rigid Plastics by mean of Barcol Impresser.                      |
| ASTM D 2584         | Test Method for Ignition Loss of Cured Reinforced Resins.   |
| ASTM G 53           | Weathering QUV Weatherometer.   |
| UKOOA               | Guidelines for Fiber Reinforced Use Offshore.   |
| USCG PFM 1-98       | US Coast Guard Guide on Fire test requirements for plastic pipe.  |
| IMO A 753(18)       | Guidelines for application of plastic pipes on ships.   |
| ISO 14692 Part 1-4  | Petroleum & Natural Gas Industries – Glass Reinforced Plastics Piping.  |

|             |                    |           |          |            |
|-------------|--------------------|-----------|----------|------------|
| FORMAT No.  | Ref. PROCEDURE No. | ISSUE No. | REV. No. | REV. DATE: |
| ODS/SOF/004 | ODS/SOP/023        | 01        | 00       | 21.07.2010 |



**OFFSHORE  
DESIGN  
SECTION**

**SPECIFICATION FOR  
PROTECTIVE  
COATING**

|              |            |
|--------------|------------|
| SPEC. No.    | 2005       |
| Rev. No.     | 9          |
| Discipline   | Structural |
| Page 1 of 78 |            |

## **SPECIFICATION FOR PROTECTIVE COATING**

| Prepared/Revised by | Reviewed by | Approved by | Pages | Date       | Rev. No. |
|---------------------|-------------|-------------|-------|------------|----------|
| MRS                 | RMK         | HMG         |       | 15.02.2012 | 3        |
| KCD /MRS            | RMK         | GRP         | 67    | 27.03.2012 | 4        |
| MRS                 | SKJ         | RMK         | 65    | 12.12.2014 | 5        |
| MRS                 | SKJ         | RMK         | 64    | 05.03.2015 | 5.1      |
| RCS                 | MRS         | RKJ         | 65    | 25.08.2016 | 6        |
| KKD                 | MRS         | RKJ         | 71    | 01.08.2018 | 7        |
| MK                  | GM          | KKD         | 71    | 26.11.2019 | 8        |
| GG                  | GM          | KCD         | 78    | 12.12.2022 | 9        |

| Format No   | Ref. Proc. No | Issue No | Rev No | Rev. Date  |
|-------------|---------------|----------|--------|------------|
| OES/SOF/028 |               | 03       | 00     | 26.02.2018 |



**OFFSHORE  
DESIGN  
SECTION**

**SPECIFICATION FOR  
PROTECTIVE  
COATING**

|                      |            |
|----------------------|------------|
| SPEC. No.            | 2005       |
| Rev. No.             | 9          |
| Discipline           | Structural |
| No of Pages: 2 of 78 |            |

## **CONTENTS**

### **1.0. INTRODUCTION**

- 1.1 Scope / General
- 1.2 Definitions

### **2.0. CODES AND STANDARDS**

- 2.1 Mandatory Statutory Requirements
- 2.2 Codes and Standards & Regulations
  - 2.2.1 The Society for Protective Coatings (SSPC)
  - 2.2.2 American Society for Testing and Materials (ASTM)
  - 2.2.3 Indian Standards (IS)
  - 2.2.4 British Standard (BS)
  - 2.2.5 International Standard of Organization (ISO)
  - 2.2.6 Occupational Safety & Health Act (OSHA)
  - 2.2.7 NACE Standard
  - 2.2.8 UL Standard
  - 2.2.9 NORSOK Standard
  - 2.2.10 American Welding Society (AWS)
  - 2.2.11 RAL Colour Chart
  - 2.2.12 Abbreviations and Definitions

### **3.0. GENERAL**

- 3.1 Blasting / Coating Exclusions

| Format No   | Ref. Proc. No | Issue No | Rev No | Rev. Date  |
|-------------|---------------|----------|--------|------------|
| OES/SOF/028 |               | 03       | 00     | 26.02.2018 |



**OFFSHORE  
DESIGN  
SECTION**

**SPECIFICATION FOR  
PROTECTIVE  
COATING**

|                      |            |
|----------------------|------------|
| SPEC. No.            | 2005       |
| Rev. No.             | 9          |
| Discipline           | Structural |
| No of Pages: 3 of 78 |            |

- 3.2 Standard Coating
- 3.3 Equipment Cleaning
- 3.4 Flanges
- 3.5 Piping Spools
- 3.6 Seal Welding
- 3.7 Over spray
- 3.8 Nozzles through Insulation
- 3.9 Coated Bolts

**4.0. SAFETY**

**5.0. ENVIRONMENTAL REQUIREMENTS**

**6.0. SURFACE PREPARATION**

- 6.1 General
- 6.2 Requirements of Blasting
- 6.3 Pre – Blasting Preparation
  - 6.3.1 Rough Edges
  - 6.3.2 Weld Flux and Splutter
  - 6.3.3 Surface Cleaning
  - 6.3.4 Chemical Contamination
  - 6.3.5 Equipment Protection
- 6.4 Blasting Operations
  - 6.4.1 Weather conditions
  - 6.4.2 Preliminary Blasting

| Format No   | Ref. Proc. No | Issue No | Rev No | Rev. Date  |
|-------------|---------------|----------|--------|------------|
| OES/SOF/028 |               | 03       | 00     | 26.02.2018 |

|  |  |   |                       |
|--|--|---|-----------------------|
|   | <b>OFFSHORE<br/>DESIGN<br/>SECTION</b> | <b>SPECIFICATION FOR<br/>PROTECTIVE<br/>COATING</b> | SPEC. No. 2005        |
|  |  |   | Rev. No. 9            |
|  |  |   | Discipline Structural |
|  |  |   | No of Pages: 4 of 78  |
| 6.4.3 Blasting and Painting<br>6.4.4 Post – Blasting Procedure<br>6.5 Blasting Equipment<br>6.5.1 Compressed Air<br>6.5.2 Nozzle<br>6.5.3 Power Tools<br>6.5.4 Shot Blasting Equipment<br>6.6 Blasting Abrasive<br>6.6.1 Abrasive<br>6.6.2 Shot Blasting Material<br>6.6.3 Alternative methods of Surface Preparation<br><b>7.0. COATING APPLICATION</b><br>7.1 General Application<br>7.1.1 Supply and Storage<br>7.1.2 Pot Life<br>7.1.3 Mixing<br>7.1.4 Unblasted Surfaces<br>7.1.5 Application Requirements<br>7.2 Cleanliness<br>7.2.1 Temperature<br>7.2.2 Weather Conditions<br>7.2.3 Coats |  |   |                       |

| Format No   | Ref. Proc. No | Issue No | Rev No | Rev. Date  |
|-------------|---------------|----------|--------|------------|
| OES/SOF/028 |               | 03       | 00     | 26.02.2018 |



|   |  |   |                       |
|---|--|---|-----------------------|
|    | <b>OFFSHORE<br/>DESIGN<br/>SECTION</b> | <b>SPECIFICATION FOR<br/>PROTECTIVE<br/>COATING</b> | SPEC. No. 2005        |
|   |  |   | Rev. No. 9            |
|   |  |   | Discipline Structural |
|   |  |   | No of Pages: 5 of 78  |
| <p>7.3 Brush application</p> <p>7.3.1 General Requirement</p> <p>7.3.2 Equipment for brush application</p> <p>7.3.3 Procedure for Brush Application</p> <p>7.4 Spray application</p> <p>7.4.1 Equipment</p> <p>7.4.2 Procedures</p> <p>7.4.3 Airless Spray Equipment</p> <p>7.4.4 Field Weld</p> <p>7.4.5 Tie / Sealer Coat</p> <p>7.5 Roller Application</p> <p>7.6 Overspray and Drip Protection</p> <p>7.7 Safety Equipment</p> <p>7.8 Handling and shipping of coated items</p> <p><b>8.0. REPAIR OF DAMAGED AREAS</b></p> <p>8.1 Repair Procedure for Coating Damage</p> <p>8.1.1 Top Coat</p> <p>8.1.2 Base Coat</p> <p><b>9.0. GALVANIZING</b></p> <p>9.1 Galvanizing Standard</p> <p>9.2 Surface Preparation</p> <p>9.3 Zinc Coating Weight</p> |  |   |                       |

| Format No   | Ref. Proc. No | Issue No | Rev No | Rev. Date  |
|-------------|---------------|----------|--------|------------|
| OES/SOF/028 |               | 03       | 00     | 26.02.2018 |

|  |  |   |                      |            |
|--|--|---|----------------------|------------|
|   | <b>OFFSHORE<br/>DESIGN<br/>SECTION</b> | <b>SPECIFICATION FOR<br/>PROTECTIVE<br/>COATING</b> | SPEC. No.            | 2005       |
|  |  |   | Rev. No.             | 9          |
|  |  |   | Discipline           | Structural |
|  |  |   | No of Pages: 6 of 78 |            |
| <p>9.4 Surface Finish</p> <p>9.5 Welding</p> <p>9.6 Damaged Items</p> <p>9.7 Reinstatement of Damaged Surfaces</p> <p>9.8 Painting Galvanized Surfaces</p> <p>9.9 Painting of Aluminum Helideck</p> <p>9.10 Painting Stainless Steel (wherever applicable)</p> <p><b>10.0. INSPECTION &amp; TESTING</b></p> <p>10.1 Quality Control</p> <p>10.2 Inspection and Testing Requirements</p> <p>10.3 Role of Paint Vendor's Representative</p> <p>10.4 Qualification of Contractor's QC personnel at Fabrication Yard (Inspectors, supervisors, foremen)</p> <p>10.5 Qualification of passive fire protection operators</p> <p>10.6 Equipment and Material</p> <p>10.7 Inspection of Instruments</p> <p>10.7.1 Calibration of Equipment</p> <p>10.7.2 Dry Film Thickness</p> <p>10.8 Repair</p> <p>10.9 Maintenance</p> <p>10.10 Roll of Company representative/Inspector/Company appointed CA/TPI</p> <p>10.11 <b>Surface preparation, Coating application &amp; field Test Report</b></p> |  |   |                      |            |

|             |               |          |        |            |
|-------------|---------------|----------|--------|------------|
| Format No   | Ref. Proc. No | Issue No | Rev No | Rev. Date  |
| OES/SOF/028 |               | 03       | 00     | 26.02.2018 |



**OFFSHORE  
DESIGN  
SECTION**

**SPECIFICATION FOR  
PROTECTIVE  
COATING**

|                      |            |
|----------------------|------------|
| SPEC. No.            | 2005       |
| Rev. No.             | 9          |
| Discipline           | Structural |
| No of Pages: 7 of 78 |            |

**11.0. PAINT MATERIALS**

11.1 Table: Required Characteristics of Paint Materials

**12.0. APPROVED VENDORS' RECOMMENDED LIST OF PAINT MATERIALS**

12.1 Table: Approved Vendor's Recommended Product

**13.0. COATING SYSTEMS**

13.1 Scope

13.2 Section A: Exterior surfaces of offshore structure

13.2.1 **Coating System No.1:** Atmospheric Zone – I (from Splash Zone to Bottom face of cellar deck plating)

13.2.2 **Coating System No.2:** Atmospheric zone – II (From Cellar Deck Plating & above)

13.2.3 **Coating System No.3:** In Splash Zone & Submerged Zone

13.2.4 **Coating System No.4:** Galvanizing

13.2.5 **Coating System No.5:** Painting of Galvanized members, Aluminum Helideck, Stainless Steel

13.3 Section B: Process vessels and piping, manifolds, valves etc.

13.3.1 Submersible pumps

13.3.2 Piping & other Equipment

13.3.3 Flanges

13.4 Section C: Compressors, gas turbine, generators, engines etc.

13.4.1 Painting when Equipment painting not satisfactory

13.4.2 Painting when blast cleaning is not permissible

13.4.3 Painting of Equipment for surface temperature upto 400°C.

13.4.4 Painting of Equipment for surface temperature above 400°C

| Format No   | Ref. Proc. No | Issue No | Rev No | Rev. Date  |
|-------------|---------------|----------|--------|------------|
| OES/SOF/028 |               | 03       | 00     | 26.02.2018 |



**OFFSHORE  
DESIGN  
SECTION**

SPECIFICATION FOR  
PROTECTIVE  
COATING

|                      |            |
|----------------------|------------|
| SPEC. No.            | 2005       |
| Rev. No.             | 9          |
| Discipline           | Structural |
| No of Pages: 8 of 78 |            |

- 13.5 Section D: Piping internal surface of tanks & process vessels
- 13.5.1 **Coating System No.6:** Painting of internal surface of tanks & process vessels
- Coating System No.6A: Salt water service
- Coating System No.6B: Hydrocarbon service
- Coating System No.6C: Fresh Water Service
- 13.6 Section E: Carbon Steel Metal Building
- 13.6.1 Equipment Skid
- 13.6.2 Structural framing/sheeting/plating
- 13.6.2.1 Exposed portion
- 13.6.2.2 **Coating System No.7:** Unexposed portion
- 13.7 Section F: Antiskid Painting
- Coating System No. 8:** Antiskid Painting
- 13.8 Section G: Passive Fire Protection
- 13.8.1 **Coating System No.9:** Epoxy Based Passive Fire Protection system (Epoxy Intumescent Coating)
- 13.9 Deleted
- 13.10 Section H: Miscellaneous items
- 13.10.1 **Pipe Support: i-Rod Pipe Support System**
- 13.10.2 **Coating System No.10:** Painting of carbon steel valves
- 13.11 Section I: Extension & Modification on Old Platform and Repair & Maintenance Painting
- 13.11.1 Evaluation of condition monitoring

| Format No   | Ref. Proc. No | Issue No | Rev No | Rev. Date  |
|-------------|---------------|----------|--------|------------|
| OES/SOF/028 |               | 03       | 00     | 26.02.2018 |

|  |  |  |                       |
|--|--|--|-----------------------|
|                                   | <b>OFFSHORE<br/>DESIGN<br/>SECTION</b> | SPECIFICATION FOR<br>PROTECTIVE<br>COATING | SPEC. No. 2005        |
|  |  |  | Rev. No. 9            |
|  |  |  | Discipline Structural |
|  |  |  | No of Pages: 9 of 78  |
| 13.11.2 Maintenance Painting system (applicable for protective coating of wellhead/ process/ LQ platform projects) |  |  |                       |
| 13.12 Miscellaneous Accessories  |  |  |                       |
| 13.13 Handling and shipping of coated items  |  |  |                       |
| <b>14.0. THERMALLY SPREAD ALUMINIUM COATING (TSAC)</b>   |  |  |                       |
| <b>15.0. COLOUR SCHEDULE</b>   |  |  |                       |
| 15.1 List of items to be painted   |  |  |                       |
| 15.2 Pipe colour coding  |  |  |                       |
| 15.3 Attachment for Pipe colour coding   |  |  |                       |
| <b>16.0. RECOMMENDED LIST OF PAINT MANUFACTURER</b>  |  |  |                       |
| <b>17.0. PROCEDURE FOR APPROVAL OF NEW COATING MATERIAL</b>  |  |  |                       |
| <b>18.0. PERFORMANCE GUARANTEE OF PROTECTIVE COATING</b>   |  |  |                       |

| Format No   | Ref. Proc. No | Issue No | Rev No | Rev. Date  |
|-------------|---------------|----------|--------|------------|
| OES/SOF/028 |               | 03       | 00     | 26.02.2018 |

|  |  |   |                       |            |
|--|--|---|-----------------------|------------|
|   | <b>OFFSHORE<br/>DESIGN<br/>SECTION</b> | <b>SPECIFICATION FOR<br/>PROTECTIVE<br/>COATING</b> | SPEC. No.             | 2005       |
|  |  |   | Rev. No.              | 9          |
|  |  |   | Discipline            | Structural |
|  |  |   | No of Pages: 10 of 78 |            |
| <b>1.0 INTRODUCTION</b>  |  |   |                       |            |
| <b>1.1 Scope</b>   |  |   |                       |            |
| <p>This specification covers the minimum requirements governing surface preparation, selection and application of the protective coating system to be used on the interior and exterior surfaces of all types of production facilities including structural steel, vessels, piping and equipment on offshore platforms.</p> <p>Individual equipment specifications and /or drawings, when furnished, are to be used with these specifications. If conflict exists, the individual specifications and/or drawings shall govern. This functional specification is applicable for both green field projects/job as well as brown field projects/job.</p> <p>It includes the requirements with respect to protection against corrosion of both Ferrous and non-ferrous metals of all types of production facilities including structural Steel, vessels, piping and equipment on offshore platforms, SBMs.</p> <p>This specification also covers the performance-based coating standard and is Applicable to painting and coating, for new construction, modifications and Maintenance of offshore facilities. All paint and coating systems to be used shall meet the qualification requirements and the minimum coating system requirements as specified in this specification.</p> <p>The coating systems to be used in accordance with this specification shall be Suitable for a Marine environment C5-M, High Durability (H) as specified in ISO 12944, NORSOK M-501 &amp; NACE SP 0108.</p> |  |   |                       |            |
| <b>1.2 Definitions</b>   |  |   |                       |            |
| <p>The following definitions shall apply:</p> <p>COMPANY : Shall mean ONGC or the designated representative.</p> <p>CONTRACTOR : Shall mean the party contracted to perform the work in accordance with the drawings, specifications and work scope.</p>   |  |   |                       |            |
| <b>2.0 CODES AND STANDARDS</b>   |  |   |                       |            |
| <b>2.1 Mandatory Statutory Requirements</b>  |  |   |                       |            |
| <p>This document has been prepared to the International Standards detailed within. The CONTRACTOR shall ensure that the Work is executed in accordance with international standards, Statutory &amp; Regulatory requirements.</p>  |  |   |                       |            |
| <b>2.2 Codes and Standards &amp; Regulations</b>   |  |   |                       |            |

|             |               |          |        |            |
|-------------|---------------|----------|--------|------------|
| Format No   | Ref. Proc. No | Issue No | Rev No | Rev. Date  |
| OES/SOF/028 |               | 03       | 00     | 26.02.2018 |



**OFFSHORE  
DESIGN  
SECTION**

**SPECIFICATION FOR  
PROTECTIVE  
COATING**

|                       |            |
|-----------------------|------------|
| SPEC. No.             | 2005       |
| Rev. No.              | 9          |
| Discipline            | Structural |
| No of Pages: 11 of 78 |            |

The requirements of the latest published versions of the following listed Codes, Recommended Practices. Specifications and standards shall be met.

**2.2.1 Steel Structure Painting Council (SSPC) (Latest Revision)**

|             |  |
|-------------|--|
| SSPC-PA1    | Shop, Field and Maintenance Painting of Steel.   |
| SSPC-PA2    | Measurement of Dry Coating Thickness with Magnetic Gauges  |
| SSPC-SP1    | Solvent Cleaning   |
| SSPC-SP2    | Hand Tool Cleaning   |
| SSPC-SP3    | Power Tool Cleaning  |
| SSPC-SP5    | White Metal Blast Cleaning   |
| SSPC-SP6    | Commercial Blast Cleaning  |
| SSPC-SP7    | Brush –Off Blast Cleaning  |
| SSPC-SP10   | Near White Blast Cleaning  |
| SSPC-SP11   | Power Tool Cleaning to bare metal  |
| SSPC-SP12   | Surface Preparation & cleaning of Steel and Other Hard material by High and Ultra High Pressure Water Jetting prior to recoating |
| SSPC-AB1    | Mineral and Slag Abrasive  |
| SSPC-AB3    | Ferrous Metallic Abrasive  |
| SSPC-SP20   | zinc rich coating Type-I(Inorganic ) & Type-II (Organic)   |
| SSPC-SP COM | Surface Preparation and Abrasives Commentary, SSPC Painting Manual, Volume 2, “Systems and Specifications”                       |
| SSPC VIS-1  | Guide and Reference Photographs for Steel Surfaces Prepared by Dry Abrasive Blast Cleaning                                       |
|             | SSPC Painting Manual   |

SSPC Vol.2

**2.2.2 American Society for Testing and Materials (ASTM) (Latest Revision)**

|            |  |
|------------|--|
| ASTM A123  | Standard Specification for Zinc (Hot-Dip Galvanized) Coatings on Iron and Steel Products                 |
| ASTM A153  | Standard Specification for Zinc-Coating (Hot-Dip) on iron and Steel Hardware                             |
| ASTM D4228 | Standard practice for qualification of coating applicators for application of coating on steel surfaces. |
| ASTM B117  | Salt Spray Test  |
| ASTM G8    | Cathodic Disbonding Test   |
| ASTM G50   | Standard practice for conducting atmospheric corrosion test  |
| ASTM G53   | Weathering Test (Part B)   |
| ASTM D520  | Standard Specification for Zinc Dust Pigment (Metallic Zinc Powder)                                      |
| ASTM D523  | Specification for Gloss  |
| ASTM D610  | Standard Practice for evaluation degree of rusting of painted steel surfaces                             |

| Format No   | Ref. Proc. No | Issue No | Rev No | Rev. Date  |
|-------------|---------------|----------|--------|------------|
| OES/SOF/028 |               | 03       | 00     | 26.02.2018 |

|  |  |   |                       |
|--|--|---|-----------------------|
|   | <b>OFFSHORE<br/>DESIGN<br/>SECTION</b> | <b>SPECIFICATION FOR<br/>PROTECTIVE<br/>COATING</b> | SPEC. No. 2005        |
|  |  |   | Rev. No. 9            |
|  |  |   | Discipline Structural |
|  |  |   | No of Pages: 12 of 78 |
| ASTM C 633 Test Method for Adhesive/Cohesive Sprayed Coating   | Strength of Flame                      |   |                       |
| ASTM D1200 Viscosity   |  |   |                       |
| ASTM D1640 Drying time   |  |   |                       |
| ASTM D1653 Standard test method for evaluation of painted or quoted specimens subject to corrosive environment                             |  |   |                       |
| ASTM D2247 relative Humidity Test  |  |   |                       |
| ASTM D2697 Volume of Solids  |  |   |                       |
| ASTM D3359 Standard test method for measuring adhesion by tape test.   |  |   |                       |
| ASTM D4060 Abrasion Resistance of Coating  |  |   |                       |
| ASTM D4285 Standard Test Method for Indicating Oil or Water in compressed air  |  |   |                       |
| ASTM D4417 Test Method for field measurement of surface profile of Blasted steel   |  |   |                       |
| ASTM D4541 Test Method for Pull-off Strength of Coating Using Portable Adhesion Testers  |  |   |                       |
| ASTM D4752 MEK Test for Testing of Zinc Silicate Paint   |  |   |                       |
| ASTM D4940 Standard Test Method for conductometric Analysis of water soluble ionic contamination of Blasting Abrasive                      |  |   |                       |
| ASTM D5894 Standard test method for evaluating drying or curing during film. Corrosion resistance under cyclic condensation/UV             |  |   |                       |
| ASTM D6386 Standard Practice for Preparation of Zinc (Hot-Dip Galvanized) Coated Iron and Steel Product and Hardware Surfaces for Painting |  |   |                       |
| ASTM E119 Standard Test Methods for Fire Test of Building Construction and Materials.  |  |   |                       |
| ASTM E1529 Standard Test Methods for Effect of Large Hydrocarbon Pool Fires on Structural Members and Assemblies                           |  |   |                       |
| <b>2.2.3 Indian Standards (Latest Revision)</b>  |  |   |                       |
| IS 5 Colours for Ready Mixed Paints and Enamels  |  |   |                       |
| IS 2379 Pipelines Identification Color Code  |  |   |                       |
| <b>2.2.4 British Standard (Latest Revision)</b>  |  |   |                       |
| BS 476: Part 20/21 Intumescent Coating   |  |   |                       |
| BS 2569: Specification for Sprayed Metal Coating   |  |   |                       |
| BS 3900 Part G7 Heat Resistance Test   |  |   |                       |
| <b>2.2.5 International Standards Organization (Latest Revision)</b>  |  |   |                       |

| Format No   | Ref. Proc. No | Issue No | Rev No | Rev. Date  |
|-------------|---------------|----------|--------|------------|
| OES/SOF/028 |               | 03       | 00     | 26.02.2018 |





**OFFSHORE  
DESIGN  
SECTION**

**SPECIFICATION FOR  
PROTECTIVE  
COATING**

|                       |            |
|-----------------------|------------|
| SPEC. No.             | 2005       |
| Rev. No.              | 9          |
| Discipline            | Structural |
| No of Pages: 13 of 78 |            |

|            |  |
|------------|--|
| ISO –898   | International Standard for Mechanical Properties of fasteners made of carbon steel and alloy steel   |
| ISO –8501  | International Standard for Preparation of Surface  |
| ISO-8502-6 | Preparation of steel substrates before application of paints & related products Tests for the assessment for surface cleanliness-:Part-6:Extraction of soluble contaminants Analysis: The Bressle Method |
| ISO –8504  | Preparation of steel substrates before application of paints and related products  |
| ISO 1461   | Hot dip galvanized coating on fabricated iron and steel articles-Specification and test methods  |
| ISO 14713  | Protection against corrosion of iron and steel structure-zinc and aluminum coating.  |
| ISO 4624   | Adhesion test of paint   |
| ISO 12944  | A Global Corrosion standard  |
| ISO 4628   | Evaluation of degradation of paint coating   |
| ISO 834    | Hydrocarbon Resistance Design (PFP)  |
| ISO 20340  | Paints and varnishes – Performance requirements for protective paint systems for offshore and related structures.  |
| ISO 4628-6 | Paints and varnishes – Evaluation of degradation of paint coatings – Designation of intensity, quantity and size of common types of defect – Part 6: Rating of degree of chalking by tape method         |

**2.2.6 Occupational Safety and Health Act**

|      |                                    |
|------|------------------------------------|
| OSHA | Occupational Safety and Health Act |
|------|------------------------------------|

**2.2.7 NACE Standards (Latest Revision)**

|                            |  |
|----------------------------|--|
| NACE SP0188                | Discontinuity (Holiday) Testing of New Protective Coatings on Conductive Substrates  |
| NACE Standard RP0287       | Field Measurement of Surface profile Measurement of abrasive blast cleaned steel surfaces using a replica tape.  |
| NACE RP0198                | The control of Corrosion Under Thermal Insulation & Fire Proofing Materials-A System Approach  |
| NACE Standard RP 0176-2003 | Corrosion control of Steel Fixed Offshore Platforms Associated with Petroleum Production   |
| NACE SP 0108               | Corrosion control of Offshore Structure by protective coating  |
| NACE 012                   | Specification for Application of Thermally Sprayed Coatings (Metallizing) of Aluminum, Zinc, and Their Alloys and Composites for the Corrosion Protection of Steel |

**2.2.8 Underwriters Laboratories**

|             |               |          |        |            |
|-------------|---------------|----------|--------|------------|
| Format No   | Ref. Proc. No | Issue No | Rev No | Rev. Date  |
| OES/SOF/028 |               | 03       | 00     | 26.02.2018 |



**OFFSHORE  
DESIGN  
SECTION**

**SPECIFICATION FOR  
PROTECTIVE  
COATING**

|                       |            |
|-----------------------|------------|
| SPEC. No.             | 2005       |
| Rev. No.              | 9          |
| Discipline            | Structural |
| No of Pages: 14 of 78 |            |

|        |   |
|--------|---|
| UL1709 | Hydrocarbon Fire Resistant Design (PFP) |
|--------|---|

**2.2.9 NORSOK Standard**

|       |  |
|-------|--|
| M-501 | Surface Preparation and Protective coating |
| M-001 | Material Selection                         |

**2.2.10 American Welding Society (AWS)**

|            |   |
|------------|---|
| AWS C.2.17 | Recommended Practice for Electric Arc Spray   |
| AWS C.2.18 | Guide for Protection of steel with Thermal Spray Coating of Aluminium ,Zinc and Their alloys and composites   |
| AWS C.2.23 | Specification for Application of Thermally Sprayed Coatings (metalizing) of aluminium ,Zinc and Their alloys and composites for corrosion protection of steel |

**2.2.11 RAL 840 HR ACQPA: COLOUR CHART**

**2.2.12 Abbreviations and Definitions**

|      |  |
|------|--|
| APAS | Australian Paint Approval Scheme                               |
| ASTM | The American Society for Testing and Materials                 |
| C    | Coating Thickness of metallic Zn (HDG coating)                 |
| COT  | College of Occupational Therapists, (UK)                       |
| CP   | Cathodic Protection DFT Dry Film Thickness                     |
| CPS  | coating procedure specification                                |
| CPT  | coating procedure test   |
| CSDS | coating system data sheet                                      |
| DFT  | Dry Film Thickness   |
| GRP  | Glass Reinforced Plastic (fiber glass)                         |
| HB   | High Build Epoxy   |
| HDG  | Hot-Dip Galvanized   |
| HP   | High Pressure (as in Water Washing at pressures above 300 Bar) |
| ITP  | Inspection and Test Plan $\mu\text{m}$ Micron                  |
| IMO  | International Maritime Organization                            |
| ISO  | International Organization for Standardization                 |
| MSDS | Material Safety Data Sheet                                     |
| MEK  | methyl ethyl ketone  |
| MSC  | Maritime Safety Committee                                      |
| NACE | National Association of Corrosion Engineers                    |
| NSF  | National Science Foundation                                    |
| OH&S | Occupational Health and Safety                                 |
| PFP  | Passive Fire Protection  |
| PIG  | Paint Inspection Gauge   |

|             |               |          |        |            |
|-------------|---------------|----------|--------|------------|
| Format No   | Ref. Proc. No | Issue No | Rev No | Rev. Date  |
| OES/SOF/028 |               | 03       | 00     | 26.02.2018 |

|   |  |   |                       |            |
|---|--|---|-----------------------|------------|
|    | <b>OFFSHORE<br/>DESIGN<br/>SECTION</b> | <b>SPECIFICATION FOR<br/>PROTECTIVE<br/>COATING</b> | SPEC. No.             | 2005       |
|   |  |   | Rev. No.              | 9          |
|   |  |   | Discipline            | Structural |
|   |  |   | No of Pages: 15 of 78 |            |
| PPE Personal Protection Equipment<br>PSPC Performance Standard for protective Coatings<br>QA Quality Assurance as defined by ISO 9001 and <del>9002 Quality Systems</del><br>QC Quality Control of production processes by activity<br>RH Relative Humidity<br>S/S Stainless steel Supplier<br>UHP WJ Ultra High Pressure Water Jetting (> 2000 Bar)<br>UL Underwriters Laboratories<br>VOC volatile organic compound<br>WB-IZS Water Borne - Inorganic Zinc Silicate<br>WFT Wet Film Thickness |  |   |                       |            |
| <b>3.0 GENERAL</b>  |  |   |                       |            |
| <b>3.1 Selection of Coating systems and application procedure shall be made with due consideration to conditions during fabrication, installation, and service of Installation.</b>   |  |   |                       |            |
| All painting activities shall be incorporated in the fabrication plan.  |  |   |                       |            |
| Details of Management, Inspectors, operators, facilities, equipments and qualified procedures shall be established and document before commencing work.   |  |   |                       |            |
| Following items shall not be coated unless otherwise specified.   |  |   |                       |            |
| <ul style="list-style-type: none"> <li>• Fibre-glass</li> <li>• plastic or other non-metallic finish</li> <li>• Equipments, valves, etc. having factory coated finish</li> <li>• Indicators</li> <li>• Sprinklers, fusible plugs and fire detectors</li> <li>• Control Valve Stems</li> <li>• Stainless Steel Control Panels</li> <li>• Stainless Steel Tubing and pipe – work</li> <li>• Cupro-Nickel (CuNi) pipe work</li> <li>• Glass Reinforced Epoxy (GRE) pipe work</li> </ul>            |  |   |                       |            |

|             |               |          |        |            |
|-------------|---------------|----------|--------|------------|
| Format No   | Ref. Proc. No | Issue No | Rev No | Rev. Date  |
| OES/SOF/028 |               | 03       | 00     | 26.02.2018 |



**OFFSHORE  
DESIGN  
SECTION**

**SPECIFICATION FOR  
PROTECTIVE  
COATING**

|                       |            |
|-----------------------|------------|
| SPEC. No.             | 2005       |
| Rev. No.              | 9          |
| Discipline            | Structural |
| No of Pages: 16 of 78 |            |

The following specific items shall not be coated and shall be protected from blasting and coating being applied to adjacent equipment

- Bearings and seals
- Flange mating faces, Raised Face (RF) and Ring Type Joint (RTJ) and flat faced
- Instrument dials and/or cases
- Cable trays and cables
- Level gauge glasses
- Nameplates Shafts and similar polished or machined surfaces Instrument Tags and Valve Position.

### 3.2 Standard Coating

The manufacturer's standard coating shall be used for the following equipment

- Indoor electrical equipment
- Instrument and control panels
- Insulated rotating equipment

### 3.3 Equipment Cleaning

The following equipment shall be cleaned with biodegradable, water soluble cleaner and an epoxy primer shall be applied (tie-coat) to the manufacturer's standard coatings prior to the specified intermediate coat.

- Fan and blower housing
- Outdoor electrical equipment
- Engines and electric motors
- Pumps, compressors and other non-insulated rotating equipment
- Control and relief valves

| Format No   | Ref. Proc. No | Issue No | Rev No | Rev. Date  |
|-------------|---------------|----------|--------|------------|
| OES/SOF/028 |               | 03       | 00     | 26.02.2018 |

|  |  |   |                       |
|--|--|---|-----------------------|
|   | <b>OFFSHORE<br/>DESIGN<br/>SECTION</b> | <b>SPECIFICATION FOR<br/>PROTECTIVE<br/>COATING</b> | SPEC. No. 2005        |
|  |  |   | Rev. No. 9            |
|  |  |   | Discipline Structural |
|  |  |   | No of Pages: 17 of 78 |
| <p>Equipment shall be recoated as specified if the coating system applied by equipment manufacturer/packager does not comply with this specification or if coating repairs is necessary.</p>   |  |   |                       |
| <p><b>3.4 Flanges</b></p> <p>Flanges on piping and valves (including control and relief valves) shall have a primer coat applied to bolt holes and the non-contact area of the face prior or being made-up. After make-up of these connections intermediate and finish coats shall be applied. Flanged ends shall have a finish coat as required in this Specification. Flange faces must not be coated.</p> |  |   |                       |
| <p><b>3.5 Piping Spools</b></p> <p>Primer and intermediate coatings and finish coat as per clause 13.2.2 shall be applied to spools pre-fabricated for offshore installation. If these spools have an end prepared for field welding, the coatings shall stop 150 mm from the prepared end.</p>  |  |   |                       |
| <p><b>3.6 Seal Welding</b></p> <p>Where enclosed or inaccessible areas cannot be adequately painted, the areas shall be completely enclosed and seal welded. Small areas inaccessible to blasting and painting that cannot be boxed by welding shall be filled with epoxy mastic, caulking compound or other suitable filler to prevent retention of dirt and moisture.</p>                                  |  |   |                       |
| <p><b>3.7 Overspray</b></p> <p>Adjacent structures, equipment and all other items shall be protected from blasting, overspray and drips with tarpaulin, plastic, tapes etc.</p>  |  |   |                       |
| <p><b>3.8 Nozzles Through Insulation</b></p> <p>Flanged nozzles, man ways, platform clips, saddles and other attachments that extend through insulation shall be coated in accordance with the coating schedule for equipment and piping.</p>  |  |   |                       |
| <p><b>3.9 Coated Bolts</b></p> <p>Galvanized bolts, studs and nuts, where used to bolt up piping, valves etc. or otherwise used to connect painted items, shall receive a top coat of paint over exposed areas after the connections are made. And shall be top coated with anti rust grease.</p>  |  |   |                       |
| <p><b>4.0 SAFETY</b></p> <p>Safety conditions shall be met, as required by the Occupational Safety and Health Act (OSHA) or other governing bodies, as well as those that are the deemed necessary.</p>  |  |   |                       |

| Format No   | Ref. Proc. No | Issue No | Rev No | Rev. Date  |
|-------------|---------------|----------|--------|------------|
| OES/SOF/028 |               | 03       | 00     | 26.02.2018 |

|  |  |   |                       |
|--|--|---|-----------------------|
|   | <b>OFFSHORE<br/>DESIGN<br/>SECTION</b> | <b>SPECIFICATION FOR<br/>PROTECTIVE<br/>COATING</b> | SPEC. No. 2005        |
|  |  |   | Rev. No. 9            |
|  |  |   | Discipline Structural |
|  |  |   | No of Pages: 18 of 78 |
| <p>Particular care must be exercised when working in close or confined spaces, especially when spraying. The maximum allowable concentration of solvent in the air shall not be exceeded. Refer to the manufacturer's recommendations to determine the maximum allowable concentration value. When volatile solvents are flammable, the concentration in air shall be kept below 25 percent of the lower explosive limit by use of adequate exhaust or ventilation facilities.</p> <p><b>5.0 ENVIRONMENTAL REQUIREMENTS</b></p> <p>The contractor will recognize COMPANY's commitment to preserving the environment and shall comply with local codes and standards for transporting, storing, and disposing of hazardous materials and hazardous wastes.</p> <p>Upon completion of the job, the contractor shall notify the COMPANY of the volume and type of hazardous waste generated.</p> <p>Upon completion of the job, all non-hazardous wastes, such as empty paint cans, clothes blasting abrasives and equipment, shall be removed by the contractor from the job sites and properly disposed.</p> <p><b>6.0 SURFACE PREPARATION</b></p> <p>6.1 General</p> <p>The surface preparation procedures and requirements except for galvanizing and cadmium plating shall be in accordance with Steel Structural Painting Council (SSPC) - SP5, SP6, SP7 &amp; SP10 and ISO-8501-1.</p> <p>All fabrication and assembly shall be completed before surface preparation is taken up. Blast and application of coating to structural and piping items prior to assembly will be permitted provided surface preparation for splice ends are taken up by portable blasting tools before application of prime coat. All field splice surface preparation for Structure &amp; Piping Items shall be carried out using portable blasting tools at field. All welding slag, weld spatters and burrs shall be removed prior to blasting. All bolt holes shall be drilled and their edges smoothed prior to blasting.</p> <p><b>First step of surface preparation:</b> Solvent cleaning is to be taken up for any surface preparation.</p> <p><b>Second step of surface preparation:</b> Steel surface shall be blast cleaned to develop specific anchor pattern/profile to develop efficient bond between paint &amp; steel surface using blasting tool or portable blasting tools for all Structural, Piping &amp; Pressure Vessel items.</p> <p>Surface preparation for Equipment, Equipment Manufacturer's procedure shall be submitted for approval of Company.</p> |  |   |                       |

| Format No   | Ref. Proc. No | Issue No | Rev No | Rev. Date  |
|-------------|---------------|----------|--------|------------|
| OES/SOF/028 |               | 03       | 00     | 26.02.2018 |



**OFFSHORE  
DESIGN  
SECTION**

**SPECIFICATION FOR  
PROTECTIVE  
COATING**

|                       |            |
|-----------------------|------------|
| SPEC. No.             | 2005       |
| Rev. No.              | 9          |
| Discipline            | Structural |
| No of Pages: 19 of 78 |            |

In case of modification work on Old Platform or Maintenance work, portable blasting tool shall be used for surface preparation. However, use of Power Tool / Hand Tool cleaning methodology can be used with approval of Company establishing constraint in use of portable blast tool and shall be applicable for specific location (not for as whole of the work/project) only.

### 6.2 Requirements of Blasting

Only dry blasting procedures are allowed. Definitions of and requirements for, the various methods of surface cleaning are given below:

- A. White Metal Blast: As per SSPC SP5 & visual reference Sa3 as per ISO 8501-1.
- B. Near-White Blast: As per SSPC SP10 & visual reference Sa2.5 as per ISO 8501-1.
- C. Commercial Blast: As per SSPC SP6 & visual reference Sa2 as per ISO 8501-1.
- D. Brush-off Blast: As per SSPC SP7 & visual reference Sa1 as per ISO 8501-1

### 6.3 Pre Blasting preparation

#### 6.3.1 Rough Edges

Sharp edges, fillets, corners and welds shall be rounded or smoothed by grinding (minimum radius 2 mm). Hard surface layers (e.g. resulting from flame cutting) shall be removed by grinding prior to blast cleaning according to ISO 8501-3, Grade-3.

All surfaces should be washed with clean fresh water prior to blast cleaning.

Any major surface defects, particularly surface laminations or scabs detrimental to the protective coating system shall be removed by suitable dressing. Where such defects have been revealed during blast cleaning, and dressing has been performed, the dressed area shall be re-blasted to the specified standard. Surface pores, cavities etc. shall be removed by suitable dressing or weld repair.

#### 6.3.2 Weld Flux and Spatter

Weld flux, slag spatter, slivers etc. shall be ground smooth before blasting. Welding surface imperfections shall be removed and surface profile shall be prepared as per ISO 12944-3.

Any surface on which grinding is done shall be spot blast cleaned or power tool cleaned to obtain required anchor pattern.

All welds shall be inspected and if necessary repaired prior to final blast cleaning of the area.

| Format No   | Ref. Proc. No | Issue No | Rev No | Rev. Date  |
|-------------|---------------|----------|--------|------------|
| OES/SOF/028 |               | 03       | 00     | 26.02.2018 |

|  |  |   |                       |
|--|--|---|-----------------------|
|   | <b>OFFSHORE<br/>DESIGN<br/>SECTION</b> | <b>SPECIFICATION FOR<br/>PROTECTIVE<br/>COATING</b> | SPEC. No. 2005        |
|  |  |   | Rev. No. 9            |
|  |  |   | Discipline Structural |
|  |  |   | No of Pages: 20 of 78 |
| <b>6.3.3 Surface Cleaning</b>  |  |   |                       |
| <p>Prior to blasting, all deposits or grease or oil shall be removed from the surface in accordance with SSPC-SP1 Solvent Cleaning using biodegradable water soluble cleaner.</p>  |  |   |                       |
| <b>6.3.4 Chemical Contamination</b>  |  |   |                       |
| <p>All chemical contamination shall be neutralized and/or flushed off prior to any other surface preparation.</p>  |  |   |                       |
| <b>6.3.5 Equipment Protection</b>  |  |   |                       |
| <p>Items such as motors, machined surfaces, gauges, electrical and instrumentation items tags and nameplates, stainless steel galvanized steel, aluminum, brass, plated surfaces etc. shall be protected to prevent damage or contamination during blasting or painting.</p> |  |   |                       |
| <p>Prior to blasting, openings on engines, pump, vessels, piping etc. shall be effectively sealed to prevent abrasive entering and damaging internal components. All packaged equipment shall be covered and special care taken to cover and seal all instrumentation.</p>   |  |   |                       |
| <b>6.4 Blasting Operations</b>   |  |   |                       |
| <b>6.4.1 Weather conditions</b>  |  |   |                       |
| <p>Blast cleaning shall not be done on any surface that is moist, or that may become moist, before the application of a primer.</p>  |  |   |                       |
| <p>No blasting is permitted when the steel temperature is less than 3°C above the dew point, as measured by a sling hydrometer, or when the relative humidity of the air is more than 85 %.</p>  |  |   |                       |
| <b>6.4.2 Preliminary Blasting</b>  |  |   |                       |
| <p>If blasting is performed at night, the surfaces shall be re-blasted the following day to provide the specified surface preparation standard and the anchor profile required for the specified coating system.</p>   |  |   |                       |
| <b>6.4.3 Blasting and Painting</b>   |  |   |                       |
| <p>Blasting shall not be done adjacent to painting operations or coated surfaces that are not fully dry. Blasting shall overlap previously coated surfaces by at least 150 mm.</p>   |  |   |                       |
| <b>6.4.4 Post – Blasting Procedure</b>   |  |   |                       |

|             |               |          |        |            |
|-------------|---------------|----------|--------|------------|
| Format No   | Ref. Proc. No | Issue No | Rev No | Rev. Date  |
| OES/SOF/028 |               | 03       | 00     | 26.02.2018 |





OFFSHORE  
DESIGN  
SECTION

SPECIFICATION FOR  
PROTECTIVE  
COATING

|                       |            |
|-----------------------|------------|
| SPEC. No.             | 2005       |
| Rev. No.              | 9          |
| Discipline            | Structural |
| No of Pages: 21 of 78 |            |

The surface to be coated shall be clean, dry, free from oil/grease, and have the **specified anchor pattern/ roughness** and cleanliness until the priming coat is applied. Blast cleaned steel surfaces shall not be touched by bare hands.

Chloride contamination shall be checked **on the blasted steel surface prior to coating application** using Salt Contamination Meter - SCM 400 / **Bresle** patches / Quantab strips. Maximum permissible limit shall be 20 mg/m<sup>2</sup> for external surface & 50 mg/m<sup>2</sup> for internal of vessels.

**Testing of soluble chloride ion content shall be carried out at least on each component, once per 200m<sup>2</sup> and a minimum of three times per shift during the progress of work. Special attention shall be given to areas where water has been trapped and dried out.**

The blast cleaned surface shall be rendered dust free and coated with the specified primer as soon as possible to avoid formation of oxidation on the surface, but **in any case within four hours from the time of blasting**, and at least one hour prior to sunset on the same day. Any steel surface not primed within these limits or that is wet shall be re-blasted.

No acid washes or other cleaning solutions or solvents shall be used on metal surfaces after they are blasted. This includes washes intended to prevent rusting.

All areas around the intended paint surface shall be cleaned of sand prior to coating. Drains shall be purged of sand and flushed.

Biodegradable water – soluble cleaning solution used to clean previously painted surfaces shall not lift softens or otherwise damages the existing coating.

## 6.5 Blasting Equipment

### 6.5.1 Compressed Air

The air compressor shall be capable of maintaining a minimum of 700 kpa (7 kg/cm<sup>2</sup> or 100 psi) air pressure at each blasting nozzle.

The compressed air supply shall be free of water and oil. Adequate separators and traps shall be provided on the equipment, which shall be regularly purged of water and oil to maintain efficiency.

### 6.5.2 Nozzle

The nozzle shall be a 10 mm (maximum) internal diameter venture style nozzle.

### 6.5.3 Power Tools (Use can be permitted with specific approval for specific location)

| Format No   | Ref. Proc. No | Issue No | Rev No | Rev. Date  |
|-------------|---------------|----------|--------|------------|
| OES/SOF/028 |               | 03       | 00     | 26.02.2018 |



**OFFSHORE  
DESIGN  
SECTION**

**SPECIFICATION FOR  
PROTECTIVE  
COATING**

|                       |            |
|-----------------------|------------|
| SPEC. No.             | 2005       |
| Rev. No.              | 9          |
| Discipline            | Structural |
| No of Pages: 22 of 78 |            |

Power tools may be used to obtain a metal surface finish as per SSPC SP11 where blasting is not possible, or on items which might be damaged by blasting.

#### 6.5.4 Shot Blasting Equipment

Shot blasting equipment may be used for specific applications. Shot shall be changed as required to maintain the angular profile requirement.

#### 6.6 Blasting Abrasive

##### 6.6.1 Abrasive

The abrasive shall be as per SSPC-AB-1. The abrasives shall be copper slag, steel balls, garnet or coal slag and shall be free of contamination of dust and chlorides to produce the required anchor profile and graded as to be free from clay, silt or other matter likely to become embedded in the steel surface. Abrasives which have a tendency to shatter and adhere or embed in the steel surface shall not be acceptable. Recycled abrasive shall not be used. Use of silica sand is not permitted.

##### 6.6.2 Shot Blasting Material

Shot blasting material shall pass through a 16 mesh screen. At least 15% steel grit shall be mixed with the graded shot to remove any rust, scale or other impurities pined into the surface by the shot. Shot blasting material is limited to iron, steel or synthetic shot which is applied by compressed air nozzles or centrifugal wheels. Shot blasting material shall be checked at least two times a week for replacement of abraded material.

##### 6.6.3 Alternative methods of Surface Preparation

###### a) For Blast Cleaning

Power Tool Cleaning shall be confined to minor areas.

Unless otherwise specified it shall be carried out in accordance with the requirement of ISO 5404-3. Power Tool Cleaning (grinding) to bare metal shall be done in accordance with SSPC SP-11.

If Power Tool Cleaning is not feasible the surface cleanliness shall as a minimum, meet visual standard PSt3 in accordance with ISO 8501-2 at the time of coating. Care shall be taken to ensure that Power Tool Cleaning does not polish the steel surface. Hand tool cleaning is permitted prior to Power Tool Cleaning. If the surface being prepared lies adjacent to a coated surface the Power Tool Cleaning shall overlap the coated surface at least by 25 mm and the coated surface shall be feathered.

| Format No   | Ref. Proc. No | Issue No | Rev No | Rev. Date  |
|-------------|---------------|----------|--------|------------|
| OES/SOF/028 |               | 03       | 00     | 26.02.2018 |



**OFFSHORE  
DESIGN  
SECTION**

**SPECIFICATION FOR  
PROTECTIVE  
COATING**

|                       |            |
|-----------------------|------------|
| SPEC. No.             | 2005       |
| Rev. No.              | 9          |
| Discipline            | Structural |
| No of Pages: 23 of 78 |            |

b) Centrifugal Abrasive Blasting: [Applicable for all local / field splice for structural & Piping Items]

A portable blasting machine using recyclable steel abrasive may be used to prepare steel decks and tank floors.

c) Vacuum Blasting

Vacuum Blasting may be used for spot repair of damaged or corroded area. It may be used in locations where open abrasive blasting is not permitted or desirable.

d) Wet abrasive blasting

Wet abrasive blast cleaning techniques may be used to avoid dust or in cases where fire and/or explosion risks are present. The cleaned surface should be washed off immediately after blast cleaning using fresh water. Corrosion inhibitors should not be used or only after written approval of the Principal. Corrosion inhibitor such as mass fraction 0.3 % sodium nitrite with mass fraction 1.2 % ammonium phosphate may be used to prevent flush rust, but Chromate inhibitors shall not be used. Corrosion inhibitor shall not be discarded into the sea. The paint Manufacturer shall approve the use of any inhibitor and the method for removing inhibitor residues before painting. The cleaned surface shall be dry at the time of painting. Particular care shall be taken to dry areas which are not self-draining, so that water collected is removed.

e) Water Jetting

High-pressure and ultrahigh-pressure water jetting may be used where abrasive blasting is not permitted because of the risk of damage to process equipment. Water jetting is restricted to maintenance painting. It is a hazardous operation and requires the use of well-trained, experienced operators. Where black spots occur in pits or other surface defects, the surface shall be cleaned again at higher pressure to remove the residual salts. Corrosion inhibitors should not be used or only after written approval of the Principal. Corrosion inhibitor such as mass fraction 0.3 % sodium nitrite with mass fraction 1.2 % ammonium phosphate may be used to prevent rust flash, but Chromate inhibitors shall not be used. Corrosion inhibitor shall not be discarded into the sea. The paint Manufacturer shall approve the use of any inhibitor and the method for removing inhibitor residues before painting.

The cleaned surface shall be thoroughly dry at the time of painting. Particular care shall be taken to dry areas which are not self-draining, so that water collected is removed.

## 7.0 COATING APPLICATION

### 7.1 General Application

| Format No   | Ref. Proc. No | Issue No | Rev No | Rev. Date  |
|-------------|---------------|----------|--------|------------|
| OES/SOF/028 |               | 03       | 00     | 26.02.2018 |

|   |  |   |                       |
|---|--|---|-----------------------|
|    | <b>OFFSHORE<br/>DESIGN<br/>SECTION</b> | <b>SPECIFICATION FOR<br/>PROTECTIVE<br/>COATING</b> | SPEC. No. 2005        |
|   |  |   | Rev. No. 9            |
|   |  |   | Discipline Structural |
|   |  |   | No of Pages: 24 of 78 |
| <p>All application, inspection and safety procedures shall be carried out in accordance with SSPC Painting Manuals, Vol. 1 Chapter 14.2 and Vol. 2 Chapter 5) and as set out below.</p> <p><b>7.1.1 Supply and Storage</b></p> <p>All coatings shall be furnished, mixed and applied in accordance with manufacturer's recommendations and as specified herein. Mixing of different manufacturer's coating applications on the same surface is not permitted.</p> <p>All coating materials and thinners shall be in original, unopened containers being the manufacturers label batch numbers and instructions. For materials having a limited shelf life, the date of manufacture and the length of life shall be shown. Materials older than their stated shelf life shall not be used.</p> <p>Materials shall be stored in accordance with the manufacturer's recommendations.</p> <p>Coating materials that have gelled, other than thixotropic materials or materials that have deteriorated during storage shall not be used.</p> <p><b>7.1.2 Pot Life</b></p> <p>If the coating requires the addition of a catalyst, the manufacturer's recommended pot life for the application conditions shall not be exceeded. When the pot life is reached, the spray pot shall be emptied, cleaned and a new material catalyzed. Manufacturer's recommendations to be followed</p> <p><b>7.1.3 Mixing</b></p> <p>Mixing and thinning directions as furnished by the manufacturer shall be followed. Only thinners specified by the manufacturer shall be used.</p> <p>All coating materials shall be stirred with a power mixer use, until the pigments, vehicles and catalysts are thoroughly mixed and then strained while being poured into the spray pot. During application the materials shall be agitated according to the manufacturer's recommendations.</p> <p>Different brands or types of paints shall not be intermixed.</p> <p><b>7.1.4 Unblasted Surfaces</b></p> <p>Coating shall not be applied within 75 mm of an unblasted surface.</p> <p>A 300 mm wide strip of uncoated, blasted surface shall be left between primed and unblasted surfaces, so as to prevent damage to the newly dried coating when additional blasting is done.</p> |  |   |                       |

| Format No   | Ref. Proc. No | Issue No | Rev No | Rev. Date  |
|-------------|---------------|----------|--------|------------|
| OES/SOF/028 |               | 03       | 00     | 26.02.2018 |

|  |  |   |                       |
|--|--|---|-----------------------|
|   | <b>OFFSHORE<br/>DESIGN<br/>SECTION</b> | <b>SPECIFICATION FOR<br/>PROTECTIVE<br/>COATING</b> | SPEC. No. 2005        |
|  |  |   | Rev. No. 9            |
|  |  |   | Discipline Structural |
|  |  |   | No of Pages: 25 of 78 |
| <b>7.1.5 Application Requirements</b>  |  |   |                       |
| <p>A Coating procedure test (CPT) shall be used to qualify all coating procedures. A suitable location on the component to be coated may be selected on which the CPT shall be carried out. Alternatively, a test panel (minimum 1 m x 1 m) containing at least 1 pipe-end (1500mm long &amp; 50 mm Ø., 1 angle and 1 flat bar (1500 mm in length) may be used for other coating systems. The coating procedures shall be qualified under realistic conditions likely to be present during coating. Selection of coating systems and application procedures shall be made with due consideration to conditions during fabrication, installation and service of the installation.</p> |  |   |                       |
| <b>7.2 Cleanliness</b>   |  |   |                       |
| <p>All Surfaces shall be clean free from dust and dry. Any blast cleaning dust or grit remaining on the surfaces shall be removed by means of compressed air before priming or application of any coating. Any surface with a rust bloom shall be re-blasted as per ISO: 8504.</p>   |  |   |                       |
| <b>7.2.1 Temperature</b>   |  |   |                       |
| <p><b><u>Coating shall only be applied when the temperature of the steel is at least 3°C above the dew point,</u></b> ambient air temperature must be within the limits specified by the manufacturer.</p>   |  |   |                       |
| <b>7.2.2 Weather Conditions</b>  |  |   |                       |
| <p><b><u>No coatings shall be applied during fog, mist or rain or when humidity is greater than 85% or on to wet surfaces.</u></b> In case the minimum temperature at the fabrication yard is below 5°C, the contractor shall propose alternate coating procedure for Company's approval at the bidding stage itself.</p>  |  |   |                       |
| <p>The company has the right to suspend application of coating when damage to the coating may result from actual or impending weather condition.</p>   |  |   |                       |
| <p>When Relative Humidity (RH) is less than 60%, Zinc rich Epoxy Primer shall be used in instead of Inorganic Zinc Silicate as per recommendation of manufacturer and with prior approval of the company.</p>  |  |   |                       |
| <b>7.2.3 Coats</b>   |  |   |                       |
| <p>Each coat shall be applied uniformly and completely over the entire surface. Each coat shall be allowed to dry for the time specified by the manufacturer before the application or a succeeding coat. To reduce the possibility of intercoat contamination and to assure proper adhesion between successive coats, all coats shall be applied as soon as possible after the minimum specified drying time of the preceding coat.</p>   |  |   |                       |

| Format No   | Ref. Proc. No | Issue No | Rev No | Rev. Date  |
|-------------|---------------|----------|--------|------------|
| OES/SOF/028 |               | 03       | 00     | 26.02.2018 |

|  |  |   |                       |
|--|--|---|-----------------------|
|   | <b>OFFSHORE<br/>DESIGN<br/>SECTION</b> | <b>SPECIFICATION FOR<br/>PROTECTIVE<br/>COATING</b> | SPEC. No. 2005        |
|  |  |   | Rev. No. 9            |
|  |  |   | Discipline Structural |
|  |  |   | No of Pages: 26 of 78 |
| <b>7.3 Brush Application</b>   |  |   |                       |
| <b>7.3.1 General Requirements</b>  |  |   |                       |
| <p>A <b>stripe coat</b> shall always be applied by brush. The stripe coat shall be applied for each coat to all edges, corners, welding seams, bolt holes, back side of piping, stiffeners, vent and drain holes, notches and any other area that is difficult to reach by spray gun &amp; where spraying may not be effective.</p> <p>The colour of the stripe coat shall be different from the previous or subsequent coat.</p> <p>Inorganic zinc primer coatings shall not be applied by brushing, not even for touch – up repairs.</p>                             |  |   |                       |
| <b>7.3.2 Equipment for Brush Application</b>   |  |   |                       |
| <p>Brushes shall be of a style and quality that will permit proper application of coating. Round or oval brushes are most suitable for rivets, bolts, irregular surfaces and rough or pitted steel. Wide flat brushes are suitable for large flat areas. Brush width shall not be greater than 100 mm. No extension handles shall be used on brushes.</p>  |  |   |                       |
| <b>7.3.3 Procedure for Brush Application</b>   |  |   |                       |
| <p>Rounding of Edges and surface preparation shall be done as per Clause No. 6.3.1 of this Specification prior to brush application.</p> <p>(a) Brushing shall be done so that a smooth coat, uniform in thickness, is obtained. There shall be no deep or detrimental brush marks.</p> <p>(b) Paint shall be worked into all crevices and corners.</p> <p>(c) All runs and sags shall be brushed out to prevent air pockets, solvent bubbles or voids.</p> <p>(d) When applying solvent type, coatings, care shall be taken to prevent lifting of previous coats.</p> |  |   |                       |
| <b>7.3.4 Finish Coat</b>   |  |   |                       |
| <p>An additional layer of finish coat shall be hand brushed at edges, corners, welds and hard-to-spray areas to eliminate holidays in the final coats.</p>   |  |   |                       |
| <b>7.4 Spray Application</b>   |  |   |                       |
| <b>7.4.1 Equipment</b>   |  |   |                       |

| Format No   | Ref. Proc. No | Issue No | Rev No | Rev. Date  |
|-------------|---------------|----------|--------|------------|
| OES/SOF/028 |               | 03       | 00     | 26.02.2018 |



**OFFSHORE  
DESIGN  
SECTION**

**SPECIFICATION FOR  
PROTECTIVE  
COATING**

|                       |            |
|-----------------------|------------|
| SPEC. No.             | 2005       |
| Rev. No.              | 9          |
| Discipline            | Structural |
| No of Pages: 27 of 78 |            |

- (a) All equipment to be used for spray applications shall be inspected and tested before application begins.
- (b) All equipment shall be maintained in good working order and shall be equal to that described in the manufacturer's instructions.
- (c) All equipment shall be thoroughly cleaned before and after each use and before adding new material.
- (d) An adequate moisture trap shall be installed between the air supply and each pressure pot. The trap shall be of the type that will continuously bleed off any water or oil from the air supply.
- (e) Suitable pressure regulators and gauges shall be provided for both the air supply to the pressure pot and the air supply to the spray gun. Spray equipment and operating pressures shall comply with the recommendations of the manufacturer.
- (f) The length of hose between the pressure pot and spray gun shall not exceed 15 m.

**7.4.2 Procedures**

- (a) Pressure pot, material hose and spray gun shall be kept at the same elevation where possible. When spraying inorganic zinc, the elevation difference shall not exceed 3m.
- (b) The spray gun shall be held at right angles to the surface.
- (c) Each pass with the spray gun shall overlap the previous pass by 50%.
- (d) The spray width shall not exceed 300 mm.
- (e) All runs and sags shall be immediately brushed out or the surface re-coated.
- (f) Large surfaces shall receive two passes (except when applying inorganic zinc) at right angles to each other (crosshatched).
- (g) The coated surface shall be checked for chloride contamination before application of subsequent coating. When surface are encountered with chloride contamination soluble salt removers shall be used before application of coatings.

**7.4.3 Airless Spray Equipment**

- (a) Airless spray equipment may be used for applying epoxy or aliphatic polyurethane coatings.

| Format No   | Ref. Proc. No | Issue No | Rev No | Rev. Date  |
|-------------|---------------|----------|--------|------------|
| OES/SOF/028 |               | 03       | 00     | 26.02.2018 |



|   |  |   |                       |
|---|--|---|-----------------------|
|    | <b>OFFSHORE<br/>DESIGN<br/>SECTION</b> | <b>SPECIFICATION FOR<br/>PROTECTIVE<br/>COATING</b> | SPEC. No. 2005        |
|   |  |   | Rev. No. 9            |
|   |  |   | Discipline Structural |
|   |  |   | No of Pages: 28 of 78 |
| (b) The manufacturer's recommendations in selection and equipment shall be followed   |  |   | use of airless spray  |
| <b>7.4.4 Field Welds</b>  |  |   |                       |
| No coating shall be applied within 150 mm of edges prepared neither for field welds nor to surfaces waiting non-destructive testing.  |  |   |                       |
| <b>7.4.5 Tie/Sealer Coat</b>  |  |   |                       |
| After application of Inorganic zinc Silicate primer, a tie/sealer coat of 25-35 $\mu\text{m}$ DFT of polyamide epoxy on top of Primer coat shall be applied in order to seal porous surface of the zinc primer as per recommendation of the Manufacturer. |  |   |                       |
| <b>7.5 Roller Application</b>   |  |   |                       |
| Roller application is permitted for paint materials where this is the manufacture's recommended method of application, such as for deck paints containing non-skid material. The manufacturer's recommended procedures shall be used.                     |  |   |                       |
| <b>7.6 Over spray and Drip Protection</b>   |  |   |                       |
| Appropriate protection of buildings, structures and equipment from drips and spray and shall be provided to all equipment and facilities.   |  |   |                       |
| <b>7.7 Safety Equipment</b>   |  |   |                       |
| Appropriate safety equipment shall be provided for blasters, painters and other workers involved in the preparation and application of coating systems as per recommendation of paint manufacturer. Work areas shall be adequately ventilated.            |  |   |                       |
| <b>7.8 Handling and shipping of coated items</b>  |  |   |                       |
| Coated items shall be carefully handled to avoid damage to coated surfaces. No handling shall be performed before the coating system is cured to an acceptable level. Packing, handling and storage facilities shall be of non-metallic type.             |  |   |                       |
| <b>8.0 REPAIR OF DAMAGED AREAS</b>  |  |   |                       |
| All areas of paintwork that are locally damaged during transportation, handling or erection shall be repaired as specified below:   |  |   |                       |
| Prior to the application of any re-coat, damaged coatings shall be removed, preparing the surface and reapplying the protective coat(s).  |  |   |                       |

| Format No   | Ref. Proc. No | Issue No | Rev No | Rev. Date  |
|-------------|---------------|----------|--------|------------|
| OES/SOF/028 |               | 03       | 00     | 26.02.2018 |



|  |  |   |                       |            |
|--|--|---|-----------------------|------------|
|   | <b>OFFSHORE<br/>DESIGN<br/>SECTION</b> | <b>SPECIFICATION FOR<br/>PROTECTIVE<br/>COATING</b> | SPEC. No.             | 2005       |
|  |  |   | Rev. No.              | 9          |
|  |  |   | Discipline            | Structural |
|  |  |   | No of Pages: 29 of 78 |            |
| <p>Following steps of repair shall be followed for damaged painted / coated areas.</p> <p><b>8.1 Repair Procedure for Damaged coating</b></p> <p>Surfaces where coating is damaged after application of the finish coat shall be repaired as follows;</p> <p><b>8.1.1 Top Coat</b></p> <p>The top coat damaged, but base coat undamaged and the metal substrate is not exposed:</p> <p>(a) Damaged coating shall be removed with a hand file and abraded back to the sound coating using emery paper or a fine grinder.</p> <p>(b) The damaged area shall be wiped with a suitable solvent to remove debris. The periphery of repair area shall be feathered back for a minimum distance of 25 mm into the adjacent undamaged coating by light abrasion or grinding to produce a smooth chamfered surface profile.</p> <p>(c) Apply a new topcoat as specified.</p> <p><b>8.1.2 Base Coat</b></p> <p>Coating damaged to base metal</p> <p>(a) The damaged area greater than 0.2m<sup>2</sup> in area, the surface of exposed metal shall be prepared to the original specified standard prior to repairing by power tool cleaning as per SSPC-SP3 or spot blasting to SSPC-SP5 and applying primer, intermediate coat and final coat as specified. Alternatively, high solid surface tolerant epoxy coating may be used in place of primer &amp; intermediate coats, followed by specified topcoat</p> <p>(b) The damaged areas less than 0.2 m<sup>2</sup> in area may be repaired as per manufacturer's recommendation or by preparing the surface of exposed metal by power tool cleaning as per SSPC-SP11 to the original specified standard.</p> <p>A primer, intermediate and final coat shall be applied as specified. Alternatively, high solid surface tolerant epoxy coating may be used in place of primer &amp; intermediate coats, followed by specified topcoat. Brush application is acceptable. Even appearance and smooth feathering into surrounding coating in addition to correct dry film thickness and holidays must be achieved. Coating and surrounding repaired areas shall not be damaged and complete tie-in of the coating with surrounding areas shall be obtained. Zinc based products shall not be applied without Blast Cleaning to Sa 2 ½, instead Surface tolerant epoxy @ 100 microns shall be used as a primer in case blast cleaning is not possible or practical.</p> <p><b>9.0 GALVANIZING</b></p> <p><b>9.1 Galvanizing Standard</b></p> |  |   |                       |            |

|             |               |          |        |            |
|-------------|---------------|----------|--------|------------|
| Format No   | Ref. Proc. No | Issue No | Rev No | Rev. Date  |
| OES/SOF/028 |               | 03       | 00     | 26.02.2018 |

|   |  |   |                       |            |
|---|--|---|-----------------------|------------|
|    | <b>OFFSHORE<br/>DESIGN<br/>SECTION</b> | <b>SPECIFICATION FOR<br/>PROTECTIVE<br/>COATING</b> | SPEC. No.             | 2005       |
|   |  |   | Rev. No.              | 9          |
|   |  |   | Discipline            | Structural |
|   |  |   | No of Pages: 30 of 78 |            |
| <p>All steel grating, stair treads, handrails, ladders and other items specified as being galvanized shall be hot-dipped after fabrication in accordance with ASTM A123. Iron and steel hardware materials shall be hot-dip galvanized in accordance with ASTM A153.</p> <p><b>9.2 Surface Preparation</b></p> <p>All welding slag and burrs shall be removed. Surface contaminants and coatings, which cannot be removed by the normal chemical cleaning process in the galvanizing operation, shall be removed by abrasive blast cleaning.</p> <p>Steelwork shall be prepared in accordance with the requirements of ASTM A123 and/or ASTM A153.</p> <p><b>9.3 Zinc Coating Weight</b></p> <p>The weight of zinc coating on structural items shall be <b>minimum 0.705 kg/m<sup>2</sup></b> surface area. The composition of the zinc used in the galvanizing bath shall not be less than 98% zinc.</p> <p><b>9.4 Surface Finish</b></p> <p>The galvanized coating shall be continuous, adherent, as smooth and as evenly distributed as possible and free from any defect that is detrimental to the end use of the coated component. On 'silicon killed' steels, the coating may be dully gray, provided the coating is sound and continuous.</p> <p><b>9.5 Welding</b></p> <p>Galvanized members, that are to be permanently fixed by welding, shall be attached after the supporting members are primed, but before topcoats are applied. The heat affected area of the supporting structure shall be cleaned of all welding flux, the surface prepared and the coating reinstated. Grinding of edges prior to welding shall be permitted to reduce zinc oxide fumes formed during welding and eliminate the potential for weld porosity to occur. Adequate ventilation shall be provided and in confined spaces a respirator shall be used.</p> <p><b>9.6 Damaged Items</b></p> <p>All damage to galvanized items caused by fabrication, welding, handling and loading out of installation shall be reinstated.</p> <p><b>9.7 Reinstatement of Damaged Surfaces</b></p> <p>Repaired surfaces shall present the same appearance as adjacent galvanized areas and have approximately the same weathering characteristics as the galvanized surface.</p> <p><b>9.8 Painting Galvanized Surfaces</b></p> |  |   |                       |            |

| Format No   | Ref. Proc. No | Issue No | Rev No | Rev. Date  |
|-------------|---------------|----------|--------|------------|
| OES/SOF/028 |               | 03       | 00     | 26.02.2018 |

|  |  |   |                       |            |
|--|--|---|-----------------------|------------|
|   | <b>OFFSHORE<br/>DESIGN<br/>SECTION</b> | <b>SPECIFICATION FOR<br/>PROTECTIVE<br/>COATING</b> | SPEC. No.             | 2005       |
|  |  |   | Rev. No.              | 9          |
|  |  |   | Discipline            | Structural |
|  |  |   | No of Pages: 31 of 78 |            |
| <p>All galvanized structural members shall be painted with coating system <b>13.7</b>. All galvanized surfaces shall be degreased, fresh water washed and treated as per SSPC SP1. It will then be sweep blasted and coated with surface tolerant epoxy – F8 as primer or compatible Epoxy primer followed by respective coating systems.</p>  |  |   |                       |            |
| <p>9.9 Painting Aluminium Helideck</p> <p><b>a) For Blast Cleaning</b></p> <p>All areas to be thoroughly cleaned with strong detergents and high pressure water to remove all traces of oil or grease. Aluminum oxide to be used as blasting media, abrasive size to be 60-80 mesh, surface profile 25-50 micron. Nozzle pressure to be 4-5 bars. During blasting nozzle movement should be continuous to avoid positional high density as aluminum is a soft metal.</p> <p>For spot repairs after painting no spot blasting is recommended, positional rectification by mechanical tool cleaning shall be done. Part by part blasting and priming is preferable than one time area blasting and priming as it is difficult to identify oxidation over aluminum surface.</p> <p><b>b) For Power Tool Cleaning</b></p> <p>All areas to be thoroughly cleaned with strong detergents and high pressure water to remove all traces of oil or grease. 3M abrasive flap of 35 or 60 meshes for electrical or pneumatic rotor grinding machine to be used for roughening the surface. It is preferable to prime the surface within 4-5 hours after cleaning to avoid oxidation over cleaned surface. Part by part blasting and priming is preferable than one time area blasting and priming as it is difficult to identify oxidation over aluminum surface.</p> <p>9.10 Painting stainless steel (wherever applicable):</p> <p>Stainless steel Handrails and ladders in the splash zone as specified in bid shall be coated as under:</p> <ol style="list-style-type: none"> <li>Surface preparation: Sweep blasting with non-metallic and chloride free grit to obtain anchor profile of approximately 25 µm to 50 µm.</li> <li>Top coat: Two component epoxy- minimum 350µm DFT.</li> </ol> <p>Also as per recommendation of paint manufacturer.</p> <p><b>10.0 INSPECTION AND TESTING PLAN (ITP)</b></p> <p>10.1 Quality Control</p> |  |   |                       |            |

| Format No   | Ref. Proc. No | Issue No | Rev No | Rev. Date  |
|-------------|---------------|----------|--------|------------|
| OES/SOF/028 |               | 03       | 00     | 26.02.2018 |



**OFFSHORE  
DESIGN  
SECTION**

**SPECIFICATION FOR  
PROTECTIVE  
COATING**

|                       |            |
|-----------------------|------------|
| SPEC. No.             | 2005       |
| Rev. No.              | 9          |
| Discipline            | Structural |
| No of Pages: 32 of 78 |            |

Procedures for testing and documenting quality control shall be prepared prior to the initial start up of any work covered by this specification & submitted to company for approval. The procedures shall include methods to assure the specification requirements are complied. Further, environmental conditions, surface temperature, coating applicator, surface(s) being coated and coating applied and status of required examinations and tests shall be documented.

Testing and inspection shall be carried out in accordance with Table-10.2. Surfaces shall be accessible until final inspection is carried out.

ITP shall include breakup of various activities, estimated time, duration for each activity. Time duration for painting activity wise is to be included in the in the planning package of the fabrication yard and adhere to the painting schedule during fabrication of structure in the yard.

Following inspection activities shall be included in the Inspection and Test Plan (ITP) furnished in Table 10.2.

**10.2 Inspection and Testing requirements**

Requirement for Inspection & Test Plan for Equipment, Pressure Vessels and Package items shall be followed as specified in respective Discipline Design Criteria or Specification

**Table 10.2.1 - Inspection and testing requirement**

| Test type                | Test Method   | Test Frequency  | Acceptance criteria   | Consequence   |
|--------------------------|---|---|---|---|
| Environmental conditions | Ambient and steel Temperature. Relative Humidity. Dew point.  | Before start of each shift + minimum twice per Shift. | In accordance with specified requirements   | No blasting or coating  |
| Visual examination       | Visual for sharp edges weld spatter slivers, rust grade, etc. | 100 % of all surfaces                                 | No defects, see specified requirements  | Defects to be repaired  |
| Cleanliness              | a) ISO 8501-1<br>b) ISO 8502-3                                | a) 100 % visual of all surfaces<br>b) Spot checks     | a) In accordance with specified Requirements<br>b) Maximum quantity and size rating 2 | a) Re-blasting<br>b) Re-cleaning and retesting until acceptable |
| Salt test                | ISO 8502-6 and ISO 8502-9                                     | Spot checks   | Maximum conductivity corresponding to 20 mg/m <sup>2</sup>                            | Repeated washing with potable water and retesting               |

|             |               |          |        |            |
|-------------|---------------|----------|--------|------------|
| Format No   | Ref. Proc. No | Issue No | Rev No | Rev. Date  |
| OES/SOF/028 |               | 03       | 00     | 26.02.2018 |

|   |  |   |   |  |
|---|--|---|---|--|
|  | <b>OFFSHORE<br/>DESIGN<br/>SECTION</b>   | <b>SPECIFICATION FOR<br/>PROTECTIVE<br/>COATING</b> | SPEC. No.   | 2005   |
|   |  |   | Rev. No.  | 9  |
|   |  |   | Discipline  | Structural   |
|   |  |   | No of Pages: 33 of 78   |  |
|   |  |   | NaCl for External surface and 50mg/m <sup>2</sup> for internal surface of Vessel. | until acceptable                                     |
| Roughness   | Comparator or stylus instrument (see ISO 8503)   | Each component or once per 200 m <sup>2</sup>       | As specified  | Re-blasting  |
| Curing test (for Zn silicate).  | ASTM D4752   | Each component or once per 100 m <sup>2</sup>       | Rating 4-5  | Allow to cure  |
| Visual examination of coating   | Visual to determine curing, contamination, solvent retention, pinholes / popping, sagging and surface defects  | 100 % of surface after each coat                    | According to specified requirements   | Repair of defects                                    |
| Holiday detection   | NACE RP0188 and as per note -1 below   | As per coating system specification                 | No holidays   | Repair and retesting.                                |
| Film thickness  | ISO 19840. Calibration on a smooth surface   | ISO 19840   | ISO 19840, and coating system data sheet  | Repair, additional coats or recoating as appropriate |
| Adhesion  | ISO 4624 using equipment with an automatic centred pulling force, and carried out when coating system are fully cured  | Each component or once per 200 m <sup>2</sup>       | *See note-2 below   | Coating to be rejected                               |
| Paint Material Inspection   | Company appointed Inspector / representative shall physically verify paint material with respect to Test Certificate, data sheet, Batch Number, Date of Manufacture, date of expire and accept the Paint material.   |   |   |  |
| Surface preparation & Priming Coat application                                    | Company appointed Inspector/ representative shall physically verify & record the surface preparation anchor pattern, record of surface salt acceptability and clear for priming coat application. Record of Temperature, Humidity and Dew point Temperature shall be recorded at the time of Start, at time interval Duration of Priming coating application and at completion time. |   |   |  |
| Application intermediate coating  | Company appointed Inspector/ representative shall carryout physical verification of coating application at random.   |   |   |  |
| Final coating application   | Company appointed Inspector/ representative shall carryout physical verification of coating application at random.   |   |   |  |
| Final coating acceptance  | Company appointed Inspector/ representative shall physically verify & record coating thickness, other field test and accept the coating.   |   |   |  |

\*Note:

|             |               |          |        |            |
|-------------|---------------|----------|--------|------------|
| Format No   | Ref. Proc. No | Issue No | Rev No | Rev. Date  |
| OES/SOF/028 |               | 03       | 00     | 26.02.2018 |



**OFFSHORE  
DESIGN  
SECTION**

**SPECIFICATION FOR  
PROTECTIVE  
COATING**

|                       |            |
|-----------------------|------------|
| SPEC. No.             | 2005       |
| Rev. No.              | 9          |
| Discipline            | Structural |
| No of Pages: 34 of 78 |            |

**1. Holiday Testing (Detection of pinholes)**

Holiday testing shall be conducted in accordance with NACE SP0188. For immersion and splash zone services, 100% of the coated areas shall be inspected for holidays. For atmospheric services, 10% of the coated areas, which include weld seams, corners, and edges, shall be holiday detected. Any holiday is unacceptable and shall be marked and repaired according to spot repair procedures. Lined vessel shall be marked clearly in black letters on vessel surface: "LINED VESSEL - HOT WORK PROHIBITED".

Pinhole testing for electrically non-conductive coatings shall be carried out in accordance with NACE RP0188 for splash zone coatings, internal tank coatings and the external coatings of buried tanks, vessels and piping. The high voltage technique shall be used; nominally set at 5 V/ $\mu\text{m}$  based on NDFT, or as agreed with the paint Manufacturer but not exceeding 25 kV in total. For coatings that are < 500  $\mu\text{m}$  DFT, the wet sponge technique may be used if approved by the company.

**2. Adhesion test**

Adhesion test shall be carried out on separate test plates, adhesion values in accordance with ISO 4624 shall be minimum 5.0MPa when using automatically centered test equipment.

**10.3 Role of Paint Vendor Representative**

The Contractor shall have to ensure that the Authorized technical-representative of the paint Manufacturer shall be qualified in accordance with NS 476 Inspector level II or certified as NACE coating inspector level II and physically inspects the painting / coating applications including surface preparation.

The Authorized technical representative of the paint Manufacturer shall have relevant knowledge of health and safety hazard, use of protection equipment, coating materials, mixing and thinning of coatings, coating pot-life, surface requirements, etc.

Paint manufacturers inspector /supervisor present in the fabrication yard shall be qualified according to NS 476 Inspector level-I, or certified as NACE coating inspector level-I and may carry out the inspection work under the guidance of an inspector level-II.

**10.4 Qualification of Contractor's QC personnel at Fabrication Yard (Inspectors, supervisors, foremen)**

The contractor's quality control inspector shall be qualified as a coating inspector in accordance with NS 476 Inspector level II or NACE level-II.

The contractor's quality control inspector shall qualify the tradesman level as blast-cleaner, painter, and applicator etc. for painting application.

| Format No   | Ref. Proc. No | Issue No | Rev No | Rev. Date  |
|-------------|---------------|----------|--------|------------|
| OES/SOF/028 |               | 03       | 00     | 26.02.2018 |



**OFFSHORE  
DESIGN  
SECTION**

**SPECIFICATION FOR  
PROTECTIVE  
COATING**

|                       |            |
|-----------------------|------------|
| SPEC. No.             | 2005       |
| Rev. No.              | 9          |
| Discipline            | Structural |
| No of Pages: 35 of 78 |            |

The personnel shall have relevant knowledge of health and safety hazard, use of protection equipment, coating materials, mixing and thinning of coatings, coating pot-life, surface requirements etc.

Contractor shall carry out tests in accordance with the painting Specification, relevant Codes & standards for all coating systems applied as per clause 13.0 that are planned to be used for this project before commencement of painting work.

Contractor shall generate Painting application document & inspection report item wise specifying date & time of application for each step of painting with test record.

The test shall be carried out on a test panel in compliance to ISO 4624.

The acceptance criteria are the requirement to the visual and non – destructive inspection of the coating system described in this specification # section 10.2. Operators failing to meet the requirement shall not be allowed to carry out the work on this project.

**10.5 Qualification of passive fire protection operators**

Operators including pump machine operator, shall be qualified, trained and certified according to the manufacturer's procedures. Before any stud welding, the welders and the procedures to be used shall be qualified in accordance with the coating manufacturer's procedures.

If the operators or stud welders have not been working with the type of application or material within a period of 12 months, the applicator shall document that necessary supplementary training have been given before start of any work.

**10.6 Equipment and Material**

Materials, tools or equipment used in the surface preparation and coating applications, shall be inspected regularly and rejected if they do not comply with the Specification.

**10.7 Inspection of Instruments**

The following items shall be inspected using the inspection instruments listed below:

| Instrument Item         | Inspection Instrument  |
|-------------------------|--|
| Surface Profile         | Keane-tator Surface Profile Comparator or Testex Press-o-Film Elcometer 124 with 122 testex tape |
| Holidays                | Tinker – Razor Model M – 1   |
| Surface Cleanliness     | SSPC – Vis – 1   |
| Viscosity               | Zahn Viscometer or Ford Cup  |
| Wet Film Thickness(WFT) | Nordson Wet Film Thickness Gauge   |

| Format No   | Ref. Proc. No | Issue No | Rev No | Rev. Date  |
|-------------|---------------|----------|--------|------------|
| OES/SOF/028 |               | 03       | 00     | 26.02.2018 |





**OFFSHORE  
DESIGN  
SECTION**

**SPECIFICATION FOR  
PROTECTIVE  
COATING**

|                       |            |
|-----------------------|------------|
| SPEC. No.             | 2005       |
| Rev. No.              | 9          |
| Discipline            | Structural |
| No of Pages: 36 of 78 |            |

|                        |  |                 |
|------------------------|--|-----------------|
|                        | Sheen WFT Gauge  |                 |
| Temperature & Humidity | Gardner Certified Hydrometer Indicator                                     | and Temperature |
| Surface Temperature    | Pandux Surface Temperature Thermometer Elcometer Surface temperature gauge |                 |
| Compressed Air Quality | Dry white cloth  |                 |

**10.7.1 Calibration of Equipment**

Each test instrument shall be maintained and calibrated as prescribed by the manufacturer.

**10.7.2 Dry Film Thickness**

The dry film thickness of the coating system shall be determined in accordance with SSPC-PA2 or by a Microtest thickness gauge (ISO 2178) or comparable instrument in accordance with the following procedure.

- (a) Ten readings shall be taken for every 10m<sup>2</sup> of painted areas.
- (b) 90% of all readings shall be within the specified dry film thickness.
- (c) Where thickness accordance with the above procedure fall below the specified minimum an additional coat of the intermediate or finish coat shall be applied.

**10.8 Repair**

All work not done in accordance with this specification shall be redone or repaired as per coating system 13.10.

**10.9 Maintenance**

For maintenance of previously coated surfaces, the condition of the existing coating and the surfaces shall be checked using suitable methods, e.g. ISO 4628, to determine whether partial or complete repainting should be carried out. The type of surface preparation and protective paint system shall then be specified. The paint manufacturer should be consulted for recommendations. Test areas may be prepared to check the manufacturer's recommendations. Coating system 13.11 shall be followed for maintenance work.

**10.10 Role of Company Representative / Company appointed TPI /CA**

Refer Table 10.2

**10.11 Surface preparation, Coating application & field Test Report**

|             |               |          |        |            |
|-------------|---------------|----------|--------|------------|
| Format No   | Ref. Proc. No | Issue No | Rev No | Rev. Date  |
| OES/SOF/028 |               | 03       | 00     | 26.02.2018 |





**OFFSHORE  
DESIGN  
SECTION**

**SPECIFICATION FOR  
PROTECTIVE  
COATING**

|                       |            |
|-----------------------|------------|
| SPEC. No.             | 2005       |
| Rev. No.              | 9          |
| Discipline            | Structural |
| No of Pages: 37 of 78 |            |

- Contractor shall generate Painting application & inspection report item wise (to be painted) for each activity of painting (surface preparation, priming, tie coat, 1<sup>st</sup> coat & final coat as applicable) specifying date & time of application. A daily record shall be maintained with following as minimum:

- (a) Air Temperature at the start, finish of the work and at intermediate stage.
- (b) Relative Humidity & dew point during application period (at interval of time).
- (c) surface roughness/ anchor profile,
- (d) Coating Material details & batch number (for traceability),
- (e) Salt test, chloride contamination
- (f) Dry film thickness applied & Identification of areas coated
- (g) Results of required field tests carried out.
- (h) Paint progress/ time lapse between coats.

These reports generated shall be documented in Construction Dossier in original and submitted to Company with PDF Copy.

**11.0 PAINT MATERIALS:**

The coating manufacturer shall provide a Coating System Data Sheet (CSDS) for each coating system to be used, containing at least the following information for each of the primer, intermediate coat (s) and topcoat product:

- Product name
- Colour
- Material type
- Batch numbers, Part A & B
- Manufacturing Date
- Shelf life
- Volatile organic compounds (VOCs) (g/l)

| Format No   | Ref. Proc. No | Issue No | Rev No | Rev. Date  |
|-------------|---------------|----------|--------|------------|
| OES/SOF/028 |               | 03       | 00     | 26.02.2018 |



**OFFSHORE  
DESIGN  
SECTION**

SPECIFICATION FOR  
PROTECTIVE  
COATING

|                       |            |
|-----------------------|------------|
| SPEC. No.             | 2005       |
| Rev. No.              | 9          |
| Discipline            | Structural |
| No of Pages: 38 of 78 |            |

- Cleaning Solvent
- Thinner Type
- Maximum percentage of thinner content by volume
- Mixing ratio by volume or weight
- Application method
- Application temperature range (°C)
- Application RH range (%)
- Induction time (minutes)
- Minimum recoat and dry to touch time (hours@ temperature)
- Maximum recoat time (days @temperature)
- Solids content by weight and/or volume
- WFT Range (µm)
- DFT Range (µm)
- Pot life (hours@ temperature)

Paint manufacturer shall furnish all the characteristics of paint materials on printed literature, along with the **test Certificate with actual test values of supplied batch for all the specified characteristics given in the specifications.**

Paint Material inward & traceability (location used) shall be maintained. These records shall be documented in Construction Dossier and submitted to Company.

All the paint materials shall be of first quality and conform to the following general characteristics are furnished below:

Table -11.1: Required **Characteristic of Paint Materials**

| Format No   | Ref. Proc. No | Issue No | Rev No | Rev. Date  |
|-------------|---------------|----------|--------|------------|
| OES/SOF/028 |               | 03       | 00     | 26.02.2018 |



**OFFSHORE  
DESIGN  
SECTION**

**SPECIFICATION FOR  
PROTECTIVE  
COATING**

|                       |            |
|-----------------------|------------|
| SPEC. No.             | 2005       |
| Rev. No.              | 9          |
| Discipline            | Structural |
| No of Pages: 39 of 78 |            |

| Descript ion | Technical name  | Type and composition   | Volume of solids (approx.) | DFT (Dry film thickness) per coat (approx.) | Theoretical covering capacity in M <sup>2</sup> /coat/litre (approx.) | Weight per litre in kgs/litre (approx.) | Touch dry at 25° C (approx.) | Hard dry at 25° C (approx.) | Over coating Interval (approx.)                            | Pot life (approx.) 25° C | Resistance to dry temperature |
|--------------|---|--|----------------------------|---|---|---|------------------------------|-----------------------------|--|--------------------------|-------------------------------|
| 1            | 2   | 3  | 4                          | 5   | 6   | 7                                       | 8                            | 9                           | 10   | 11                       | 12                            |
| F-1          | Epoxy MIO High build finish paint   | Two pack polyamide cured epoxy, pigmented with lamellar micaceous iron oxide | 80 ± 5%                    | 100-125u                                    | As per suppliers data   | 1.4                                     | 3 hours                      | Over night                  | Min. : Over night<br>Max. : as recommended by manufacturer | 2 hrs.                   | 90°-120° C                    |
| F-2          | Self-priming surface tolerant High build Epoxy coating  | Two pack epoxy resin based suitably pigmented                                | 80 ± 5%                    | 100-125u                                    | As per suppliers data   | 1.4                                     | 3 hours                      | 24 hours                    | Min. : 10 hours<br>Max: as recommended by manufacturer     | 90 minutes               | 90°-120° C                    |
| F-3          | Inorganic zinc-silicate coating SSPC SP-20, Level-II, containing 80±3% zinc in dry film by weight & zinc as per ASTM D520 Type-II | A two pack air drying solvent based Inorganic Zinc silicate coating.         | 65 ± 5%                    | 65-75u                                      | 8-9   | 2.3                                     | 30 mts                       | less than 6 hours           | Min. 16-24 hours<br>Max. as recommended by manufacturer    | 2 to 4 hours             | 400° C                        |
| F-4          | Organic zinc rich epoxy coating SSPC SP-20, Level-II, containing 80±3% zinc in dry film by weight & Zinc as per ASTM D520 Type-II | Two pack epoxy resin based zinc primer                                       | 65 ± 5%                    | 65-75u                                      | As recommended by manufacturer  | 2.5                                     | 75 mts                       | less than 6 hours           | Min. ; 6 hours<br>Max. ; as recommended by manufacturer    | 5 hours                  | 90-120° C                     |

|             |               |          |        |            |
|-------------|---------------|----------|--------|------------|
| Format No   | Ref. Proc. No | Issue No | Rev No | Rev. Date  |
| OES/SOF/028 |               | 03       | 00     | 26.02.2018 |



**OFFSHORE  
DESIGN  
SECTION**

**SPECIFICATION FOR  
PROTECTIVE  
COATING**

|                       |            |
|-----------------------|------------|
| SPEC. No.             | 2005       |
| Rev. No.              | 9          |
| Discipline            | Structural |
| No of Pages: 40 of 78 |            |

|      |  |  |        |  |                                |         |           |           |  |                                |             |
|------|--|--|--------|--|--------------------------------|---------|-----------|-----------|--|--------------------------------|-------------|
| F-5  | Heat resistant Aluminum paint based on Moisture Curing Silicone Binder | Single pack moisture cured silicon resin based medium with aluminum flakes | 40±5 % | 20-25u   | As recommended by manufacturer | 1.1     | 30 mts    | 1-2 hours | Min. ; 6-12 hours<br>Max. ; as recommended by manufacturer | Not applicable                 | Upto 600° C |
| F-6  | Epoxy Phenolic based Tank Lining (see note-1)                          | Two Pack Epoxy Phenolic Based  | 60±5 % | 125 u-150µ   | As per suppliers data          | Min 1.4 | 5 hours   | 8 hours   | Min. ; 8 hours<br>Max. ; as recommended by manufacturer    | As recommended by manufacturer | Upto 200° C |
| *F-7 | Epoxy Passive fire protection (PFP)                                    |  | 100%   | As per risk analysis Study report & as recommended by manufacturer |                                |         |           |           |  |                                |             |
| F-8  | Extra High Build Epoxy   | Two pack polyamide/Polyamide cured epoxy resin                             | 100±5% | 2500 µm  | As per suppliers data          | Min 1.9 | 8 hours   | Ovenight  | <b>Min. 4 hrs<br/>Max. As recommended By manufacturer</b>  | 30 minutes                     | 140° C      |
| F-9  | Glossy Aliphatic Acrylic Polyurethane Topcoat                          | Two Components Aliphatic Acrylic Polyurethane                              | 60±5 % | 65-80 µm   | As per suppliers data          | --      | 1.5 hours | 6 hours   | Min. 6 hours<br>Max. ; As per suppliers data               | 1 hour                         | 90° -120° C |

|             |               |          |        |            |
|-------------|---------------|----------|--------|------------|
| Format No   | Ref. Proc. No | Issue No | Rev No | Rev. Date  |
| OES/SOF/028 |               | 03       | 00     | 26.02.2018 |



**OFFSHORE  
DESIGN  
SECTION**

**SPECIFICATION FOR  
PROTECTIVE  
COATING**

|                       |            |
|-----------------------|------------|
| SPEC. No.             | 2005       |
| Rev. No.              | 9          |
| Discipline            | Structural |
| No of Pages: 41 of 78 |            |

|      |   |   |         |             |                       |     |                          |                          |                                    |                          |           |
|------|---|---|---------|-------------|-----------------------|-----|--------------------------|--------------------------|------------------------------------|--------------------------|-----------|
| F-10 | Solvent free epoxy for Drinking / potable water tanks (see note-2)  | A Two pack solvent free epoxy tank coating for drinking water       | 100%    | 250-300µm   | As per suppliers data | --  | 6 hrs                    | 12 hrs                   | Min. ; 10 hours<br>Max. ; 40 hours | 1 hour                   | Upto 60°C |
| F-11 | Ultra High Build glass flake Epoxy  | A Two component glass flake Epoxy coating                           | 96%± 2% | 600-1000 µm | As per suppliers data | --  | Refer Product Data Sheet | Refer Product Data Sheet | Refer Product Data Sheet           | Refer Product Data Sheet | 90-100 °C |
| F-12 | Pure epoxy pigmented with aluminium (see note-3)  | A Two component Pure epoxy coating pigmented with aluminium         | 60%± 2% | 100-200 µm  | As per suppliers data | --- | 3 hours                  | 6 hours                  | 7 hours -14 days                   | 2.5 hours                | ---       |
| F-13 | Low volume solid epoxy primer<br>As recommended by paint manufacturer   | A Two pack epoxy solvent free epoxy tank coating for drinking water | 47%± 2% | 40 µm       | As per suppliers data | --- | 30 minutes               | 8 hours                  | As recommended by supplier         | 8 hours                  | --        |
| F-14 | Sealer coat TSAC<br>As recommended by paint manufacturer  | Used as Sealer for TSAC<br>Operating temperature >120°C             | 30%     | 15-25 µm    | --                    | --- | 20 minutes               | 2 hours                  | As recommended by supplier         | --                       | --        |
| F-15 | One coat of fast curing solvent less UV -resistant polyester resin (Isophthalic based reinforced with glass flakes. | Glass flake reinforced unsaturated Polyester coating                | 96%± 2% | 600-1500 µm | As per suppliers data | --  | 2 hours                  | 2 hours                  | As recommended by supplier         | 45 minutes               | 90-100 °C |

**Note:**

1.

IMO PSPC COT Resolutions MSC. 288 (87)

|             |               |          |        |            |
|-------------|---------------|----------|--------|------------|
| Format No   | Ref. Proc. No | Issue No | Rev No | Rev. Date  |
| OES/SOF/028 |               | 03       | 00     | 26.02.2018 |



**OFFSHORE  
DESIGN  
SECTION**

**SPECIFICATION FOR  
PROTECTIVE  
COATING**

|                       |            |
|-----------------------|------------|
| SPEC. No.             | 2005       |
| Rev. No.              | 9          |
| Discipline            | Structural |
| No of Pages: 42 of 78 |            |

2. APAS Approved to specification 0213, 2974F & 2974P / UL Certified in accordance to NSF/ANSI 61. [In case of water tank constructed using stainless steel SS316L, tank internal coating is not required.]

3. Approved for PSPC for water ballast tank according to IMO Res. MSC 215 (82)

**12.0 APPROVED VENDOR'S RECOMMENDED LIST OF PAINT MATERIALS**

Table-12.1: **Approved Vendor's Paint products**

| Description   | Area of application                 | Berger Paints Ltd., India | Shalimar Paints, India | Carboline, USA (CDC) Carboline, India | Sigma Coatings (PPG Coatings), USA | Hempel, Denmark                  | Amercoat (PPG Coatings), USA | Jotun Coatings, Norway / Jotun India Pvt Ltd | KCC Corporation, Korea | International Brand (AKZO NOBEL), UK | Chogoku paints, Singapore | Excel India Paints, India |
|---|-------------------------------------|---------------------------|------------------------|---------------------------------------|------------------------------------|----------------------------------|------------------------------|--|------------------------|--------------------------------------|---------------------------|---------------------------|
| 1   | 2                                   | 3                         | 4                      | 5                                     | 6                                  | 7                                | 8                            | 9  | 10                     | 11                                   | 12                        | 13                        |
| F-1 Epoxy MIO High Build finish   | Exterior surface of steel <120°C    | Epilux 455 HB MIO         | epiguard XL            | Carboguard 893 MIO                    | sigma cover 410 (MIO)              | Hempadur Mastic 45880/1W / 47550 | Amercote 383 HS / 410 (MIO)  | Penguard Midcoat MIO                         | Korepox EH2350         | Interseal 547/ Intergard 475 HS      | Univan MIO                | EXL GUARD 495             |
| F-2 Self-priming surface tolerant High build Epoxy  | Maintenance painting                | Berger Protectomastic RPL | epiplus 56             | Carbomastic 615                       | Sigma Cover 630 / 620              | Hempadur Mastic 45880/1W / 47550 | amerlock 400 / 400C          | Jotamastic 80/Jotaprime mastic 80            | Korepox Primer EP 1760 | Interseal 547/ Intergard 670 HS      | Umeguard HS               | EXL GUARD 680             |
| F-3 Inorganic zinc silicate coating SSPC SP-20, Level-II, containing minimum 80% zinc in dry film by weight & zinc as per ASTM D520 Type-II | Primer coat Relative Humidity > 60% | Zinc anode 304 Coating    | tuffcote zilicate -IZS | cabozinc 11                           | Sigma Zinc 158                     | Hempel's Galvosil 15780          | dimeitcote 9                 | Resist 78/Resist 804A                        | Galvany IZ 180 (N)     | Interzinc 2280                       | Galbon S-HB               | EXLZINC 113               |

|             |               |          |        |            |
|-------------|---------------|----------|--------|------------|
| Format No   | Ref. Proc. No | Issue No | Rev No | Rev. Date  |
| OES/SOF/028 |               | 03       | 00     | 26.02.2018 |



**OFFSHORE  
DESIGN  
SECTION**

**SPECIFICATION FOR  
PROTECTIVE  
COATING**

|                       |            |
|-----------------------|------------|
| SPEC. No.             | 2005       |
| Rev. No.              | 9          |
| Discipline            | Structural |
| No of Pages: 43 of 78 |            |

| Description   | Area of application   | Berger Paints Ltd., India    | Shalimar Paints, India | Carboline, USA (CDC) Carboline, India | Sigma Coatings (PPG Coatings), USA | Hempel, Denmark                  | Amercoat (PPG Coatings), USA | Jotun Coatings, Norway / Jotun India Pvt Ltd | KCC Corporation, Korea          | International Brand (AKZO NOBEL), UK | Chogoku paints, Singapore | Excel India Paints, India |
|---|---|------------------------------|------------------------|---------------------------------------|------------------------------------|----------------------------------|------------------------------|--|---------------------------------|--------------------------------------|---------------------------|---------------------------|
| 1   | 2   | 3                            | 4                      | 5                                     | 6                                  | 7                                | 8                            | 9  | 10                              | 11                                   | 12                        | 13                        |
| F-4 Organic zinc rich epoxy coating SSPC SP-20, Level-II, containing minimum 80% zinc in dry film by weight & Zinc as per ASTM D520 Type-II | Primer coat When Relative Humidity < 60% & Primer for repair work | Epilux ZR HB Primer          | Epigard 4              | Carbozinc 858                         | Sigma zinc 109 HS                  | Avantguard 1736 G                | Amercoat 68 HS               | Barrier 80                                   | Korepox Zinc Rich Primer EZ 175 | Interzinc 52                         | -                         | EXLZINC 108               |
| F-5 Heat resistant Aluminum paint based on Silicone Binder  | Temperature >400° C For equipments                                | Lumerous HR143               | Iustotherm 600         | Thermaline 4700 aluminium             | Sigmatherm540                      | Hempel's Silicon aluminium 56914 | Amercoat 878 HS              | Solvalitt                                    | Yeolcoat QT 606                 | Intertherm 50                        | -                         | EXLTHERM HR600            |
| F-6 Epoxy Phenolic based Tank Lining  | Internal lining of Diesel & crude oil tank                        | Epilux 9 HB Phenolic Coating | HB finish              | Phenoline 187 VOC                     | sigma guard 730                    | hempadur 85671                   | Amercoat 90 HS               | Tankguard storage                            | Kophenol EH2630                 | Interline 850                        | -                         | EXLLINI 965               |
| *F-7 Epoxy (PFP) (See note-2 below)   | Protection of platform from pool and jet fire                     | -                            | -                      | Pyroclad X1                           | PITT-CHAR XP                       | Hempafire Pool 200               | PITT-CHAR XP                 | Jotachar JF 750/Jotachar 1709                | Firemask 3200                   | Chartek-7/ Chartek-7E/ Chartek-1709  | -                         | EXLINTUMESCENT 447        |

|             |               |          |        |            |
|-------------|---------------|----------|--------|------------|
| Format No   | Ref. Proc. No | Issue No | Rev No | Rev. Date  |
| OES/SOF/028 |               | 03       | 00     | 26.02.2018 |



**OFFSHORE  
DESIGN  
SECTION**

**SPECIFICATION FOR  
PROTECTIVE  
COATING**

|                       |            |
|-----------------------|------------|
| SPEC. No.             | 2005       |
| Rev. No.              | 9          |
| Discipline            | Structural |
| No of Pages: 44 of 78 |            |

| Description   | Area of application  | Berger Paints Ltd., India      | Shalimar Paints, India                     | Carboline, USA (CDC) Carboline, India | Sigma Coatings (PPG Coatings), USA | Hempel, Denmark                      | Amercoat (PPG Coatings), USA | Jotun Coatings, Norway / Jotun India Pvt Ltd | KCC Corporation, Korea  | International Brand (AKZO NOBEL), UK | Chogoku paints, Singapore | Excel India Paints, India |
|---|--|--------------------------------|--|---------------------------------------|------------------------------------|--------------------------------------|------------------------------|--|-------------------------|--------------------------------------|---------------------------|---------------------------|
| 1   | 2  | 3                              | 4  | 5                                     | 6                                  | 7                                    | 8                            | 9  | 10                      | 11                                   | 12                        | 13                        |
| F-8 Extra High Build Epoxy                            | Steel plated helideck, walkways, escape route & laydown area | -                              | -  | Carboguard 1207                       | Sigmashield 1090                   | Hempel's Spray Guard 35490/3         | Tideguard 171                | Jotacote UHB                                 | Korepox H.S.EH3200      | Interzone 485                        | -                         | EXL GUARD-991UHB          |
| F-9 Glossy Aliphatic Acrylic Polyurethane Topcoat     | Finish coat for UV protection & required colour              | Bergerthane Acrylic PU Coating | Shalithane HB rich                         | Carbothane 134HG                      | Sigmadur 550 / 585                 | Hempathane topcoat 55910/55610/55210 | Amercoat 450 Series          | Hardtop XP/Futura OS                         | Korethan Topcoat UT6581 | Interthane 990/ Interthane 990 SG    | -                         | EXLTHANE 570              |
| F-10 Solvent free Epoxy                               | Internal lining of potable water tank                        | Epilux 155 SF                  | -  | Carboguard 703                        | Sigma Guard CSF 650 / 585          | Hempadur 35530/35531                 | Amercoat 391 PC              | Tankguard 412                                | Korepox H.B.EH3100      | Interline 925                        | -                         | EXLLINE-989SF             |
| F-11 Ultra High Build glass flake Epoxy (Splash Zone) | Protection of structure in splash zone                       | Steel shield 1100              | Tuffkote<br>Epishield ST glass flake epoxy | Carboguard 1209                       | Sigmashield 905 / 880GF            | Hempadur Multistrength 35870         | Amerlock 400GF               | Marathon XHB                                 | Korepox H.B.EH3200 (GF) | Interzone 1016                       | Permax no.3000 S          | EXL GUARD- 890GF          |

|             |               |          |        |            |
|-------------|---------------|----------|--------|------------|
| Format No   | Ref. Proc. No | Issue No | Rev No | Rev. Date  |
| OES/SOF/028 |               | 03       | 00     | 26.02.2018 |





**OFFSHORE  
DESIGN  
SECTION**

**SPECIFICATION FOR  
PROTECTIVE  
COATING**

|                       |            |
|-----------------------|------------|
| SPEC. No.             | 2005       |
| Rev. No.              | 9          |
| Discipline            | Structural |
| No of Pages: 45 of 78 |            |

| Description  | Area of application   | Berger Paints Ltd., India | Shalimar Paints, India | Carboline, USA (CDC) Carboline, India | Sigma Coatings (PPG Coatings), USA | Hempel, Denmark                     | Amercoat (PPG Coatings), USA | Jotun Coatings, Norway / Jotun India Pvt Ltd       | KCC Corporation, Korea         | International Brand (AKZO NOBEL), UK | Chogoku paints, Singapore | Excel India Paints, India |
|--|---|---------------------------|------------------------|---------------------------------------|------------------------------------|-------------------------------------|------------------------------|--|--------------------------------|--------------------------------------|---------------------------|---------------------------|
| 1  | 2   | 3                         | 4                      | 5                                     | 6                                  | 7                                   | 8                            | 9  | 10                             | 11                                   | 12                        | 13                        |
| F-12<br>Pure epoxy pigmented with aluminium  | Internal lining of ballast water/salt water tank  | .                         | .                      | Carbomastic 615A                      | Sigmacover 280                     | Hempadur uniq 47741/<br>4774 D      | Amercoat182ZP                | Jotacote universal alu./<br>Jotacote universal N10 | Korepox EH2030                 | Intershield 300                      | .                         | EXL GUARD- 343            |
| F-13<br>Low volume solid epoxy primer<br>As recommended by paint manufacturer      | Used as Sealer/<br>Tie coat for TSAC & Over Zinc silicate primer<br>Operating temperature <120° C | .                         | .                      | Carboguard 893ZP                      | Sigmacover 522/246                 | Hempadur<br>05990/15553/15570       | Amercoat 182 ZP/71 TC        | Penguard tie coat 100<br>/Penguard primer          | Korepox Holding Primer EP 1700 | Intergard 269                        | .                         | EXL GUARD- 247            |
| F-14<br>Aluminium silicone sealer/tie coat<br>As recommended by paint manufacturer | Used as Sealer for TSAC<br>Operating temperature >120° C  | .                         | .                      | Thermaline 1248 E                     | Sigmatherm 540                     | Hempel's Silicon aluminium<br>56914 | Amercoat 878                 | .  | .                              | Intertherm 50/ Intertherm 972        | .                         | EXL THERM-530             |

|             |               |          |        |            |
|-------------|---------------|----------|--------|------------|
| Format No   | Ref. Proc. No | Issue No | Rev No | Rev. Date  |
| OES/SOF/028 |               | 03       | 00     | 26.02.2018 |



**OFFSHORE  
DESIGN  
SECTION**

**SPECIFICATION FOR  
PROTECTIVE  
COATING**

|                       |            |
|-----------------------|------------|
| SPEC. No.             | 2005       |
| Rev. No.              | 9          |
| Discipline            | Structural |
| No of Pages: 46 of 78 |            |

| Description                      | Area of application   | Berger Paints Ltd., India | Shalimar Paints, India | Carboline, USA (CDC) Carboline, India | Sigma Coatings (PPG Coatings), USA | Hempel, Denmark             | Amercoat (PPG Coatings), USA | Jotun Coatings, Norway / Jotun India Pvt Ltd | KCC Corporation, Korea | International Brand (AKZO NOBEL), UK | Chogoku paints, Singapore | Excel India Paints, India |
|----------------------------------|---|---------------------------|------------------------|---------------------------------------|------------------------------------|-----------------------------|------------------------------|--|------------------------|--------------------------------------|---------------------------|---------------------------|
| 1                                | 2   | 3                         | 4                      | 5                                     | 6                                  | 7                           | 8                            | 9  | 10                     | 11                                   | 12                        | 13                        |
| F-15 Glass flake Polyester resin | Splash zone to bottom of Cellar deck (Maintenance Painting) | ---                       | ---                    | ---                                   | -                                  | Hempel's Polyester GF-35920 | Amercoat -4800               | Baltoflake                                   | -----                  | Interzone-762                        | -----                     | EXL GUARD 891GF           |

**Note:**

1. The paint materials indicated in the table are indicative only and may be updated. Bidder is to select & procure latest paint material from the list of the recommended list of paint manufacturers meeting the DFT requirement of paint.
2. \*Epoxy (PFP) installed on the platform shall be Tough, durable and resistant to impact and vibration damage. Thickness of coating shall be based on risk analysis study report and fire safety measures to be taken to mitigate hydrocarbon and jet fire as per ISO 22899 jet fire certification up to 2 hours and NORSOK M-501. FIRE RATING shall implement based on safety study carried out in compliance to API 14J & API RP 2A.
3. Contractor to verify the latest status of availability & applicability of products before consideration and report their intention of change within the above listed vendors with proper reasons.

**13.0 PROTECTIVE COATING SYSTEMS**

**13.1 SCOPE**

Manufacturer's recommendations and latest product of paint shall be used to suit the environment conditions and for the intended purpose shall be followed. Care must be taken to achieve the specified dry film thickness indicated in the bid. **Items to be painted covered by these specifications are as follows:**

**13.2 Section A: New Construction of offshore structure.**

|             |               |          |        |            |
|-------------|---------------|----------|--------|------------|
| Format No   | Ref. Proc. No | Issue No | Rev No | Rev. Date  |
| OES/SOF/028 |               | 03       | 00     | 26.02.2018 |



**OFFSHORE  
DESIGN  
SECTION**

**SPECIFICATION FOR  
PROTECTIVE  
COATING**

|                       |            |
|-----------------------|------------|
| SPEC. No.             | 2005       |
| Rev. No.              | 9          |
| Discipline            | Structural |
| No of Pages: 47 of 78 |            |

**13.2.1 Coating System No.1:** Atmospheric Zone-I: Thermally sprayed aluminium coating shall be applied for items having service life of 10 years or longer which are :

13.2.1.1 exposed to seawater & not easily accessible for inspection or maintenance:-

- i) structural Steel items, piping, piping supports etc. **above splash zone** upto & including **Bottom plating of cellar deck**,
- ii) Conductors, Pump & Sump Caisson.
- iii) bottom framing beams & plating of Main Deck
- iv) bottom chord of Bridge including bottom of plating , piping .piping supports etc
- v) Boom of pedestal crane
- vi) Steel framing supporting helideck above main deck and upto and including bottom of steel helideck.

TSAC is not required for bottom of aluminium pancake.

13.2.1.2 Exposed to operating temperature > 120 °C as heat resistance paint.

- i) Flare Stack/vent boom

13.2.1.3 :Table for TSAC System

| Application  | Surface Preparation   | Coating System  | DFT   |
|--|---|---|---|
| <b>Coating System No.1A</b><br>All carbon steel surfaces exposed to operating temperature > 120 °C. <ul style="list-style-type: none"> <li>• Flare Stack/vent boom.</li> </ul>   | Cleanliness:<br>SSPC –SP5/ Sa 3<br>Surface Profile: Minimum<br>75 µm    | Thermally sprayed<br>Aluminium or alloys of<br>aluminium with sealer<br>coat as top coat.<br>*Sealer: (F-14)  | 225 µm (Min value<br>200 µm & Max value<br>250 µm )<br>For sealer, see<br>Note- 1   |
| <b>Coating System No.1B</b><br>All carbon steel surfaces exposed to atmosphere & operating temperature < 120 °C. <ul style="list-style-type: none"> <li>• Jacket above splash zone up to and including Cellar Deck bottom surface including bottom of deck plating, primary &amp; secondary beams etc.</li> <li>• Main deck bottom surface including bottom of deck plating, primary &amp; secondary beams etc.</li> </ul> | Cleanliness:<br>SSPC-SP5/ Sa 3<br><br>Surface Profile: Minimum<br>75 µm | Thermally sprayed<br>aluminium or alloys of<br>aluminium with sealer,<br>intermediate coat and final<br>coat as top coat<br><br>*Sealer: (F-13)<br>*Intermediate Coat (F-1)<br>*Final Coat(F-9) | 225 µm (Min value<br>200 µm & Max value<br>250 µm )<br>See Note- 1 : Sealer<br>Coat<br>Note- 2: Intermediate<br>Coat<br>Note- 3: Final coat |

|             |               |          |        |            |
|-------------|---------------|----------|--------|------------|
| Format No   | Ref. Proc. No | Issue No | Rev No | Rev. Date  |
| OES/SOF/028 |               | 03       | 00     | 26.02.2018 |



**OFFSHORE  
DESIGN  
SECTION**

**SPECIFICATION FOR  
PROTECTIVE  
COATING**

|                       |            |
|-----------------------|------------|
| SPEC. No.             | 2005       |
| Rev. No.              | 9          |
| Discipline            | Structural |
| No of Pages: 48 of 78 |            |

|   |  |  |  |
|---|--|--|--|
| <ul style="list-style-type: none"> <li>Bottom chord of bridge connecting offshore platforms including bottom of deck plating</li> <li>Steel framing supporting helideck above main deck and upto bottom of helideck below aluminium pancake &amp; bottom of steel helideck plating</li> <li>boom of pedestal crane</li> </ul> |  |  |  |
|---|--|--|--|

\*Note-1: All metallized surfaces shall be sealed in accordance with the following requirements: The sealer shall fill the metal pores. It shall be applied until absorption is complete. There should not be a measurable overlay of sealer on the metallic coating after application.

The materials for sealing the metal coating shall be:

- Two-component epoxy for operating temperatures below 120 °C (F-13).
- Aluminium silicone above 120 °C (F-14).

Volume solids in the sealers when applied shall be 15 % nominal. The overlay of sealer should be less than 38 µm (1.5 mil) on the TSA coating after application.

The sealer should have a contrasting color to the TSA to aid visual inspection.

\*Note-2: Intermediate coat over TSAC shall be applied as per coating system no.2

\*Note -3: Final coat TSAC shall be applied as per coating system no.2

Application of Thermally Spread Aluminium Coating (TSAC) is specified in Clause No. 14.0.

- Repair, field coating of pipes and coating of in-fill steel

All requirements, including adhesion, applicable to metal spraying, shall apply.

The treating and handling of the substrate shall be done in such a manner that the product in its final condition will have a continuous and uniform coating. Before the metal spraying operation starts, the area 30 cm to 40 cm in distance from the weld zone shall be sweep-blasted to ensure that all contamination is removed. The uncoated welding zone shall be blast Cleaned as specified for coating system no. 1.

**13.2.2 Coating System No.2: Atmospheric zone - II except for zone specified under coating system no. 1**

| Application Area | Surface Preparation | Coating System | Coating DFT Range |
|------------------|---------------------|----------------|-------------------|
|                  |                     |                |                   |

| Format No   | Ref. Proc. No | Issue No | Rev No | Rev. Date  |
|-------------|---------------|----------|--------|------------|
| OES/SOF/028 |               | 03       | 00     | 26.02.2018 |



**OFFSHORE  
DESIGN  
SECTION**

**SPECIFICATION FOR  
PROTECTIVE  
COATING**

|                       |            |
|-----------------------|------------|
| SPEC. No.             | 2005       |
| Rev. No.              | 9          |
| Discipline            | Structural |
| No of Pages: 49 of 78 |            |

|  |   |  |                          |
|--|---|--|--------------------------|
| Carbon steel with operating temperature < 120 °C<br>– Structural steel, Exteriors of equipment, vessels, piping and valves (not insulated) in Atmospheric Zone <b>except for zone specified under coating system no. 1</b> | Cleanliness: Near white metal shot/grit blasting as Per SSPC-SP-10 or Sa 2 ½ of SIS-05-5900 /ISO 8501-1 surface profile : 40-60 µm Max. | Primer Coat: Inorganic zinc silicate primer (F-3)  | 65 - 75 µm               |
|  |   | Sealer Coat/tie coat: Low volume solid epoxy (F-13) as recommended by paint manufacturer | 25 - 30 µm               |
|  |   | Intermediate coats: Two coat of high build epoxy (F-1) with MIO pigments                 | 100 – 125 µm (each coat) |
|  |   | Finish Coat: One Topcoat of Gloss Aliphatic Acrylic Polyurethane (F- 9)                  | 65 - 80 µm               |
|  |   | Total DFT µm   | 355-435 µm               |

**Notes:**

1. This system is applicable for carbon steel surface with operating temperature less than 120° C.
2. Colour for final coat shall be as per colour code.

**13.2.3 Coating System No.3: Protection of Carbon Steel in Submerged & Splash Zone**

| Application  | Surface Preparation   | Coating System  | Coating DFT Range                          |
|--|---|---|--|
| Coating System No.3A:<br>Submerged Zone<br>• PLEM, SSIV and Riser clamps, etc.   | Cleanliness: Near white metal shot/grit blasting as Per SSPC-SP-10 or Sa 2 ½ of SIS-05-5900/ISO 8501-1<br>Surface profile: 40-60 µm Max.  | two coat epoxy based primer with aluminium pigment (F-12)       | 100-125µm (each coat)<br>Total 200 µm min. |
| Coating System No.3B:<br>Splash zone:<br>Jacket, Boat landing, Barge Bumper, conductors, Riser & Conductor Protector, clamps, etc. | Cleanliness: Near white metal shot/grit blasting as Per SSPC-SP-10 or Sa 2 ½ of SIS-05-5900/ISO 8501-1<br>Surface profile: 75-100 µm Max. | Two coats of Ultra High Build Glass Flake Epoxy Coating (F- 11) | 750 µm (each coat)<br>Total 1500 µm min.   |

**13.2.4 Coating System No.4: Galvanizing**

All grating, handrails, ladders, safety cages shall be hot dip galvanized as per ASTM 123 & misc. hardware shall be hot dip galvanized ASTM A153. Galvanizing shall preferably be done after cutting shaping and welding has been done. The weight of zinc coating for grating, handrails, ladders, safety cages shall be minimum **705 gm** per square meter (**coating thickness of 100 µm**).

The weight/thickness of zinc coating for iron and steel hardware shall be as per ASTM A153.

The galvanized surface shall be free from bare spots, dross pimples, Lumpiness and runs, flux inclusions and slag inclusions.

|             |               |          |        |            |
|-------------|---------------|----------|--------|------------|
| Format No   | Ref. Proc. No | Issue No | Rev No | Rev. Date  |
| OES/SOF/028 |               | 03       | 00     | 26.02.2018 |



**OFFSHORE  
DESIGN  
SECTION**

**SPECIFICATION FOR  
PROTECTIVE  
COATING**

|                       |            |
|-----------------------|------------|
| SPEC. No.             | 2005       |
| Rev. No.              | 9          |
| Discipline            | Structural |
| No of Pages: 50 of 78 |            |

**13.2.5 Coating System No.5: Painting of All Galvanized items (as per 13.2.4) except gratings & Aluminium Helideck shall coated as below:**

| Application   | Surface Preparation  | Coating System  | DFT in $\mu\text{m}$          |
|---|--|---|-------------------------------|
| All Galvanised items and Aluminium Helideck painting for marking, lettering, etc. | SSPC SP1 & etched chemically with etch primer or physically by sweep blast cleaning with non-metallic and chloride free grit to SSPC SP7/Sa1. Cleaning with alkaline solution followed by hosing with fresh water as per SSPC SP1. surface profile : 25-50 $\mu\text{m}$ | Low volume solid epoxy primer suitable for aluminium & galvanized surface. (F-13) | Minimum 50 $\mu\text{m}$      |
|   |  | Intermediate coat: Two coat of high build epoxy with MIO pigments. (F- 1)         | 100 $\mu\text{m}$ (each coat) |
|   |  | Finish Coat: One coat of aliphatic polyurethane. (F-9)                            | Minimum 75 $\mu\text{m}$      |
|   |  |   | Minimum DFT 325 $\mu\text{m}$ |

**13.3 SECTION B: New Construction: Process vessels and piping, valves, manifolds, pumps, heat exchangers and related equipment**

13.3.1 All submersible type pumps protective coating system shall be as per manufacturer's standard which shall be suitable for Marine environment. Holiday test shall be carried out on protective coatings of all equipment as per NACE SP 0188.

**13.3.2 Piping & other equipment**

For Piping & other equipment made up of Carbon Steel Material, Protective coating system shall be followed as per Clause No. 13.2.2.

**13.3.3 Flanges**

Flanges on equipment to be installed on offshore platforms shall be coated with the protective coating system given in 13.2.2 except for the seal surface. Care shall be taken to prevent damage of ring and gasket seal surface by covering during the blasting and coating. After the coating has cured, an anti-rust grease coating shall be applied to protect the seal surface. Apply a minimum dry film of an anti-rust grease coating as per MIL-C-161730 Amendment, 2, Grade 1 Qualified Products List.

A corrosion control material (such as inhibitor grease) should be installed correctly initially after the flange has been assembled on the offshore structure. The bolt holes and flange crevices shall be sealed off completely from the offshore corrosive environment.

| Format No   | Ref. Proc. No | Issue No | Rev No | Rev. Date  |
|-------------|---------------|----------|--------|------------|
| OES/SOF/028 |               | 03       | 00     | 26.02.2018 |



**OFFSHORE  
DESIGN  
SECTION**

**SPECIFICATION FOR  
PROTECTIVE  
COATING**

|                       |            |
|-----------------------|------------|
| SPEC. No.             | 2005       |
| Rev. No.              | 9          |
| Discipline            | Structural |
| No of Pages: 51 of 78 |            |

Commercially available viscous sealants, such as soft and low-molecular-weight polyolefin sealants or corrosion inhibitor greases, should be injected into the flange crevice. The sealants are very hydrophobic. A polymeric tape or SS tape should then be wrapped around the flange to enclose the flange crevice completely.

Petrolatum or wax tapes may be used for ambient to moderate temperature service applications in accordance with the product manufacturer's specification.

For maintenance, the entire flange should be overwrapped with a commercial petrolatum or wax tape, which is made of polyester felt impregnated with very hydrophobic petrolatum or wax to provide encapsulation against water. Visual inspection cannot be conducted without unwrapping the tape. However, the flange shall be wrapped again after the inspection. Tape shall be replaced if the encapsulation is broken.

All Painted Nut bolts used for flanged/bolted connection shall be protected from corrosion by providing Protective caps with inhibited grease as per recommendation of the vendor.

**13.4 SECTION C: COMPRESSORS, GAS TURBINES, GENERATORS, ENGINES, MOTORS, INSTRUMENTS AND PANEL BOARDS**

Equipment in covered/enclosed areas shall be coated as per Equipment manufacturer's standards coating suitable for **offshore environment** as specified in respective Specification wherever provided in Bid, otherwise Protective System given in 13.2.2 shall be followed.

All skid surfaces which can be cleaned by blasting shall be coated with one of the protective system given in 13.2.2. Protect critical moving parts, bearing surfaces, machined surfaces, nameplates, glass next to machinery, etc. from entrance of blasting dust and damage from blasting by masking with polyethylene sheeting and masking tape. Equipment in enclosed areas shall be protected with the same paint systems as for exterior surface. Panel boards shall be disassembled before cleaning and coating.

13.4.1 When equipment manufacturer's coating is unsatisfactory and blast cleaning is not permissible. Clean and protect as follows:

- a. Remove coating by use of a paint and varnish remover.
- b. Surface preparation; solvent cleaning (SSPC-SPI) followed by power tool cleaning (SSPC-SP3 or St3) or of SIS-05-5900.
- c. One coat of (F-2) Self priming surface tolerant epoxy coating @ 125 Microns DFT/Coat minimum (maximum DFT-150 microns)
- d. Top Coat – 2 coats (F-1) High build epoxy MIO coating cured with Polyamide/polyamine hardener @ 125 microns DFT/Coat minimum (maximum DFT – 150 microns/coat) = 2 X 125 =250 microns.

| Format No   | Ref. Proc. No | Issue No | Rev No | Rev. Date  |
|-------------|---------------|----------|--------|------------|
| OES/SOF/028 |               | 03       | 00     | 26.02.2018 |





**OFFSHORE  
DESIGN  
SECTION**

**SPECIFICATION FOR  
PROTECTIVE  
COATING**

|                       |            |
|-----------------------|------------|
| SPEC. No.             | 2005       |
| Rev. No.              | 9          |
| Discipline            | Structural |
| No of Pages: 52 of 78 |            |

e. Finish Coat- One Topcoat of (F- 9) Gloss Aliphatic Acrylic Polyurethane 60-80 micron dry film thickness

Total DFT: Minimum: 435 microns, Maximum: 530 microns.

13.4.2 When equipment manufacturer's shop primer is sound and blast cleaning is not permissible, clean and top coat as follows (where finish coat has to be done at the yard):

- a. Surface preparation: Solvent cleaning (SSPC-SPI), followed by power tool cleaning (SSPC-SP) or St 3 of SIS-05-5900.
- b. Apply one coat of (F-2) Self priming surface tolerant epoxy coating @ 125 Microns DFT/Coat minimum (maximum DFT-150 microns)
- c. Top coat: as per 13.4.1 (d) above.

13.4.3 Painting System applicable for Equipment having surface temperature between 110°C (230°F) and 400° C (752°F), clean and protect as follows.

- a. Surface Preparation: Near white metal shot/grit blasting as per SSPC-SP-10 or Sa 2 ½ of SIS-05-5900/ISO 8501 –1:2001 with a 40 – 60 microns anchor pattern. Items with metal to metal joints shall be seal welded prior to blasting and coating when possible or dismantled following all fittings and welding to obtain blasting and coating of the joint surfaces
- b. Apply 1 coat inorganic zinc silicate primer coating (F-3) @ 65-75 Microns DFT minimum (maximum – 75 microns).
- c. Apply 2 coats (F- 5) of Heat resistant silicon aluminum finish paint @ minimum 20 microns DFT per coat = 2 X 20 = 40 microns (maximum 2 X 25 = 50 microns).

Total DFT: 105 Microns minimum: 125 microns maximum.

**Note** : coating having operating temperature less than 120 degree shall be coated as specified in respective Discipline Spec.

13.4.4 Equipment with surface temperature above 400°C (752°F),

- a. Surface Preparation: Near white metal shot/grit blasting as per SSPC-SP-10 or Sa 2 ½ of SIS-05-5900/ISO 8501 –1:2001 with a 40 – 60 microns anchor pattern. Items with metal to metal joints shall be seal welded prior to blasting and coating when possible or

| Format No   | Ref. Proc. No | Issue No | Rev No | Rev. Date  |
|-------------|---------------|----------|--------|------------|
| OES/SOF/028 |               | 03       | 00     | 26.02.2018 |





**OFFSHORE  
DESIGN  
SECTION**

**SPECIFICATION FOR  
PROTECTIVE  
COATING**

|                       |            |
|-----------------------|------------|
| SPEC. No.             | 2005       |
| Rev. No.              | 9          |
| Discipline            | Structural |
| No of Pages: 53 of 78 |            |

dismantled following all fittings and welding to obtain blasting and coating of the joint surfaces

**b. Apply 2-3 coats of Heat resistant silicon aluminium finish paint (F-5) (maximum 3 X 20 µm – 25 µm).**

Total DFT: 60 µm minimum: 75 µm maximum.

**13.5 SECTION D: Internal Surfaces of Tanks and Process Piping/SPM**

**Vessels/**

**13.5.1 Coating System No.6: Coating of Internal Surfaces of Tanks and Process Vessels/Piping/SPM**

| Application   | Surface Preparation   | Coating System  | DFT in µm   |
|---|---|---|---|
| System No.6A:<br>Salt Water Service (ballast tanks/internal sea water filled compartments)                                  | Cleanliness: Near white metal shot/grit blasting as Per SSPC-SP-10 or Sa 2 ½ of SIS-05-5900/ISO 8501-1<br>Surface profile: 60-85µm Max. | *Two coats of Epoxy pigmented with aluminium (F-12)<br>(See Note-3) | 150 µm (each coat)<br>Total Min DFT 300 µm.           |
| System No.6B:<br>Hydrocarbon Services: all internal surfaces of Welded tanks handling hydrocarbons/diesel.                  | Cleanliness: Near white metal shot/grit blasting as Per SSPC-SP-10 or Sa 2 ½ of SIS-05-5900/ISO 8501-1<br>Surface profile: 50-85µm Max. | *Two coats of Phanoic Epoxy (F-6)<br>(See Note-1)                   | 125 µm – 150 µm (each coat)<br>Total Min. DFT 250 µm. |
| System No.6C:<br>Fresh Water Services: all internal surfaces of Welded tanks handling portable water having NSF Certificate | Cleanliness: Near white metal shot/grit blasting as Per SSPC-SP-10 or Sa 2 ½ of SIS-05-5900/ISO 8501-1<br>Surface profile: 50-85µm Max  | Two coats of Solvent free Epoxy. (F-10)<br>(See Note-2)             | 250 µm – 300 µm (each coat)<br>Total Min DFT 500 µm   |

\*Note-1: Certified to NSF / ANSI Standard.

\*Note-2: Paint shall be tested and certified according to AS/NZS4020:2005 or UL classification in accordance with ANSI/NSF Standard for potable water.

Note-3: Paint shall be for PSPC for water ballast tank according to IMO Res .MSC 215.

Note-4: Paint System 6C: Potable Water Tank made up of SS316, internal surface painting is not required.

Note-5: Paint System 6B: Pressure vessel internal painting shall be followed as per respective Spec of the item provided in the bid. In case, respective specification do not have specific requirement then Paint System 6B is to be followed.

|             |               |          |        |            |
|-------------|---------------|----------|--------|------------|
| Format No   | Ref. Proc. No | Issue No | Rev No | Rev. Date  |
| OES/SOF/028 |               | 03       | 00     | 26.02.2018 |



**OFFSHORE  
DESIGN  
SECTION**

**SPECIFICATION FOR  
PROTECTIVE  
COATING**

|                       |            |
|-----------------------|------------|
| SPEC. No.             | 2005       |
| Rev. No.              | 9          |
| Discipline            | Structural |
| No of Pages: 54 of 78 |            |

Note-6: Internal Surfaces of Tanks shall be coated as per intended use specified in this specification and respective Discipline Specification provided in the Bid.

**13.6 SECTION- E: Carbon steel Metal buildings**

**13.6.1 Equipment Skid**

Structural Steel: Method of surface preparation and acceptable coatings shall be followed as per Coating system No.2 Section – A (13.2.2).

Piping/Mechanical & Process: As per Section – B (13.3)

13.6.2 Structural Framing/Sheeting/Plating: Method of surface preparation and acceptable coatings shall be followed as per Coating System No.2

13.6.2.1 Exposed portions: Method of surface preparation and acceptable coatings shall be followed as per Coating system No.2 except Walkways, escape routes and lay down areas.

13.6.2.2 Unexposed portions covered by insulation, wall Panels, false roofing/ceiling and false flooring:

**Coating System No.7: Painting of Unexposed portions**

| Application  | Surface Preparation   | Coating System   | DFT in               |
|--|---|--|----------------------|
| Portions covered by insulation, wall Panels, false roofing and false flooring) | Cleanliness: Near white metal shot/grit blasting as Per SSPC-SP-10 or Sa 2 ½ of SIS-05-5900/ISO 8501-1 surface profile: 40-60 µm Max. | Primer Coat: Inorganic zinc silicate primer (F-3)  | 65 -85 µm            |
|  |   | Sealer Coat/tie coat: One coat of low volume of epoxy Primer (F- 13) as recommended by manufacturer. | 25-30 µm             |
|  |   | Finish coat: One coat of high build epoxy with MIO pigments. (F- 1)                                  | 125 – 150 µm.        |
|  |   | Total DFT (Minimum)  | Total Min DFT 215 µm |

**13.7 Section F - Antiskid Painting**

Coating system is applicable on **Steel plated Helideck**, Plated **Laydown Area**, Plated **Walkway**, and applicable area on **plated floor**.

**Coating System No.8: Antiskid Painting.**

|             |               |          |        |            |
|-------------|---------------|----------|--------|------------|
| Format No   | Ref. Proc. No | Issue No | Rev No | Rev. Date  |
| OES/SOF/028 |               | 03       | 00     | 26.02.2018 |



**OFFSHORE  
DESIGN  
SECTION**

**SPECIFICATION FOR  
PROTECTIVE  
COATING**

|                       |            |
|-----------------------|------------|
| SPEC. No.             | 2005       |
| Rev. No.              | 9          |
| Discipline            | Structural |
| No of Pages: 55 of 78 |            |

| Application   | Surface Preparation                              | Coating System   | DFT in $\mu\text{m}$    |
|---|--|--|-------------------------|
| Topcoat of <b>Steel plated Helideck, Laydown Area, Walkway (Plated) &amp; Plated flooring</b> | Cleanliness: SSPC –SP5/ Sa 3                     | <b>Extra high</b> build epoxy coating. Application as recommended by paint Manufacturer. (F-8)<br>Top coat: one coat of Aliphatic acrylic polyurethane (F-9) (Refer General Note 1 to 4 below) | 2500-3000 $\mu\text{m}$ |
|   | Roughness: 75 $\mu\text{m}$ to 100 $\mu\text{m}$ |  | 50-60 $\mu\text{m}$     |
|   |  | Total DFT  | 2550-3060 $\mu\text{m}$ |

**General notes:**

1. Light colour non-skid aggregates shall be used.
2. Quantity and Particle size of non-skid aggregate shall be as per recommendation of paint manufacture.
3. Aggregates shall have a uniform spread.
4. Coating system No.8 shall have adequate properties related to water absorption, impact resistance, coefficient of friction (**at least 0.65 in wetted condition**), hardness and flexibility.

**13.8 Section G : Passive Fire Protection**

The recommended use for this product is for fireproofing of steel beams below cellar deck, Deck Legs, Jacket legs & braces, pipes, vessel skirts, bulkheads etc. for fire rating as per Fire Safety Study Report.

The epoxy intumescent coating shall provide pool and jet fire protection minimum one hour for well platform & two hours for Process platform.

Coating thickness shall be as per recommended by paint Manufacturer to obtain desired Fire rating based on safety study.

Base coat & Top coating on top of the passive fire protection shall be compatible with the passive fire protection coating. No hot work shall be done after fireproofing material is installed. Procedure for application shall be as per manufacturers' quality and application manual.

**13.8.1 \*Coating System No.9:** Epoxy Based Passive Fire Protection system (Epoxy Intumescent Coating)

| Application                     | Surface Preparation   | Coating System   | DFT in $\mu\text{m}$ |
|---------------------------------|---|--|----------------------|
| Carbon steel – Structural steel | Cleanliness: Near white metal shot/grit blasting as Per SSPC-SP-10 or Sa 2 ½ of SIS-05-5900/ISO 8501-1 surface profile : 40-60 $\mu\text{m}$ Max. | Primer Coat: Inorganic zinc silicate primer (F-3)  | 65 -85 $\mu\text{m}$ |
|                                 |   | Sealer Coat/tie coat: Low volume epoxy primer as recommended by paint manufacturer (F-13)                  | 25-30 $\mu\text{m}$  |
|                                 |   | Top Coat: Thickness of Fire proofing coating shall be provided by Manufacturer for the desired Fire Rating |                      |

| Format No   | Ref. Proc. No | Issue No | Rev No | Rev. Date  |
|-------------|---------------|----------|--------|------------|
| OES/SOF/028 |               | 03       | 00     | 26.02.2018 |



**OFFSHORE  
DESIGN  
SECTION**

**SPECIFICATION FOR  
PROTECTIVE  
COATING**

|                       |            |
|-----------------------|------------|
| SPEC. No.             | 2005       |
| Rev. No.              | 9          |
| Discipline            | Structural |
| No of Pages: 56 of 78 |            |

|  |  |
|--|--|
|  | (as per safety study). Coating material F-7. |
|--|--|

\*Note: Epoxy Intumescent Coating shall be applied over a suitably primed substrate as per Recommendation of paint manufacturer. Procedure for application shall be as per Manufacture's Quality & application manual.

Epoxy Intumescent Coating shall be top coated to meet colour schemes & finish and as per recommendation of paint manufacturer.

The fire ratings of Epoxy Intumescent Coating shall be obtained from Certification Agencies like UL, LRS, DNV, BV, etc. and submitted.

No hot work shall be carried out after completion of Fire proofing coating.

**13.9 Deleted**

**13.10 Section H: Miscellaneous items**

**13.10.1 Pipe Support: I-Rod Pipe Support System**

Corrosion Control in Piping Support & anchoring Steel U- Bend shall be carried out as per NACE SP 0108 (Standard Practice – Corrosion Control of Offshore Structure by Protective Coating).

Pipe Support shall also be so designed that there is no water accumulation beneath the pipe to avoid corrosion and deterioration of paint. Design of pipe support shall be such that there shall be enough space for recoating even at the bottom of pipe. One of method is to use semi sphere-shaped **Thermoplastic Pipe Support** Rod under the pipe to facilitate water drainage for future corrosion inspection and access to recoat. Alternative option is to overwrap the pipe wherever the pipe is being supported with a layer of fiber glass reinforced composite tape with adhesive backing. Alternatively contractor may also propose other alternative accordingly.

The U-bend shall be protected with a carbon black pigmented polychloroprene rubber sheath. The rubber sheath shall also provide abrasion resistance. Corrosion inhibitor grease should be applied onto the steel U-bend prior to inserting in the rubber sheath.

Contractor shall address all such aspect in Piping support standard and put up to Company for approval.

**13.10.2 Coating System No.10: Painting of carbon steel valves.**

|             |                     |                |                      |
|-------------|---------------------|----------------|----------------------|
| Application | Surface Preparation | Coating System | DFT in $\mu\text{m}$ |
|-------------|---------------------|----------------|----------------------|

|             |               |          |        |            |
|-------------|---------------|----------|--------|------------|
| Format No   | Ref. Proc. No | Issue No | Rev No | Rev. Date  |
| OES/SOF/028 |               | 03       | 00     | 26.02.2018 |

|   |  |   |   |            |
|---|--|---|---|------------|
|    | <b>OFFSHORE<br/>DESIGN<br/>SECTION</b>   | <b>SPECIFICATION FOR<br/>PROTECTIVE<br/>COATING</b> | SPEC. No.   | 2005       |
|   |  |   | Rev. No.  | 9          |
|   |  |   | Discipline  | Structural |
|   |  |   | No of Pages: 57 of 78                               |            |
| Painting of carbon steel valves with operating temperature up to 150°C.   | Cleanliness: Near white metal shot/grit blasting as Per SSPC-SP-10 or Sa 2 ½ of SIS-05-5900/ISO 8501-1<br>Surface profile: 40-60 µm Max. | Two coats of Phenolic Epoxy (F- 6)                  | 150 – 175 µm (each coat)<br>Total Min<br>DFT 300 µm |            |
| <p><b>13.11 Section I: Extension &amp; Modification on Old Platform and Repair &amp; Maintenance painting of offshore platform</b></p> <p>i. Extension &amp; Modification on Existing Platform Section A to H shall be followed with following change: Thermally Spread Aluminum Coating (TSAC) System is not applicable.</p> <p>ii. Repair &amp; Maintenance Painting.</p> <p>13.11.1 Evaluation of condition monitoring</p> <p>The Principal will review the condition monitoring reports. Facility components found to be Inaccessible for coating condition inspection should be reported to the responsible Technical Authorities and Management. The barrier coating should be maintained within Two (2) years after the condition of the barrier is found to be not in accordance with the Minimum acceptance criteria. If repair work has not been carried out in time or if severe (Local) corrosion has been observed during condition monitoring, the responsible disciplines should be consulted on further actions to ensure safety and technical integrity.</p> <p>The condition of all the components of an area/block, including insulation and passive Fireproofing, should be reviewed when drafting scopes of work for maintenance. Consideration should be given to whether it is justified to repair the coating barrier of a Single component only, or whether the whole area/block should be maintained. Specialist Knowledge, including insight into costs and techniques, may be required to make the choice between repair and large-scale maintenance. Specific consideration should be given to and thorough analysis made of areas and/or parts that cannot be inspected or maintained. Appropriate actions, such as risk analyses etc., to ensure long-term integrity should be instigated.</p> <p><b>VISIBLE CORROSION DEGREES</b></p> <p>The pictures given in ASTM D 610 can be used for the visual determination of the percentage of surface Rusting. These pictures are based on standards such as the European Scale of Degree of Rusting and ASTM D 610.</p> <p>13.11.2 : Maintenance Painting system (applicable for protective coating of wellhead/ process/ LQ platform projects) shall be as under:</p> |  |   |   |            |

|             |               |          |        |            |
|-------------|---------------|----------|--------|------------|
| Format No   | Ref. Proc. No | Issue No | Rev No | Rev. Date  |
| OES/SOF/028 |               | 03       | 00     | 26.02.2018 |



**OFFSHORE  
DESIGN  
SECTION**

**SPECIFICATION FOR  
PROTECTIVE  
COATING**

|                       |            |
|-----------------------|------------|
| SPEC. No.             | 2005       |
| Rev. No.              | 9          |
| Discipline            | Structural |
| No of Pages: 58 of 78 |            |

| Maintenance Protective Coating System             | Area of application  | Surface Preparation  | Surface Profile | Product   | DFT   |
|---|--|--|-----------------|---|---|
| <u>Maintenance Protective Coating System no.1</u> | From 1.0 meter below MSL to bottom of cellar deck framing (excluding underside of cellar deck framing, piping, pipe support, equipment)<br>Including Jacket, Boat landing, Barge Bumper, conductors, Conductor Protector, riser clamps, conductors, conductor guides, sump/pump caissons and all other structural members.<br>Design life for this system shall be 10 years.   | SSPC-SP-10 / Sa 2 ½  | 50-75µm         | One coat of fast curing solvent less UV -resistant polyester resin (Isophthalic based reinforced with glass flakes.(F-15)   | 750 µm  |
| <u>Maintenance Protective Coating System no.2</u> | a) All items from bottom of cellar deck framing ( including underside of cellar deck framing & plating (both sides) to top of topside including conductors & conductor guides , external surface of Pressure vessel, X- mas' tree and steel cable trays & structural items including existing handrails except helideck top, walkways, gratings, new handrails, Vent boom, barrier/fire wall facing well head area, crane exhaust<br>b) All piping , equipment & piping supports above & below cellar deck framing<br>c) All other items below cellar deck which are not included in Maintenance Protective Coating System no. 1.<br>Design life for this system shall be 5 years. | SSPC-SP1 to be followed by hand/powder tool cleaning<br>SSPC-SP2/<br>SSPC-SP3. | -               | a) 1 coat of 2 component surface tolerant polyamine cured self-priming epoxy @ 100-125µm/coat. (F-2)<br>b) 1 coat of 2 component polyamide cured high build epoxy coating @ 100-125µm/coat.(F-1)<br>c) 1 coat of Acrylic Aliphatic Polyurethane finish paint @ 50-75 µm/coat.(F-9)<br><br><b>Total DFT</b><br><b>Note:</b><br>Carbon Steel Flange and external side of valves shall be painted by Brush applied stripe coat of 2 component surface tolerant polyamine cured self-priming epoxy coating at all corners, edges, pit, welds followed by application of (b) & (c) above . | 100-125 µm<br><br>100-125 µm<br><br>50-75µm<br><br>250-325 µm |
| <u>Maintenance Protective Coating system no.3</u> | Carbon steel floorings For Walkways & Steel Helideck (NACE SP 0108) including markings and lettering.  | SSPC-SP-10 / Sa 2 ½  | 50-75 µm        | 1 coat of Glass Flake epoxy with anti-skid system as crushed flint / anti slip beads @ 600-650 µm.(F-11)<br><br>1 coat of Acrylic Aliphatic   | 600-650 µm  |

|             |               |          |        |            |
|-------------|---------------|----------|--------|------------|
| Format No   | Ref. Proc. No | Issue No | Rev No | Rev. Date  |
| OES/SOF/028 |               | 03       | 00     | 26.02.2018 |



**OFFSHORE  
DESIGN  
SECTION**

**SPECIFICATION FOR  
PROTECTIVE  
COATING**

|                       |            |
|-----------------------|------------|
| SPEC. No.             | 2005       |
| Rev. No.              | 9          |
| Discipline            | Structural |
| No of Pages: 59 of 78 |            |

|  |   |  |          |  |  |
|--|---|--|----------|--|--|
|  |   |  |          | PU @ 50-75 μ.(F-9)   |  |
|  |   |  |          | <b>Total DFT:</b><br><b>Colour scheme shall be conforming to CAP 437 offshore helicopter landing areas.</b>  | 50-75 μm<br><b>650-725 μm.</b>                             |
| <b><u>Maintenance Protective Coating system no.4</u></b> | Top coat of fire/barrier walls  | SSPC-SP1 to be followed by hand/power tool cleaning SSPC-SP2/SSPC-SP3.   | -        | Under epoxy based fire protection system<br>1 coat of Surface Tolerant Epoxy @ 100 μm.(F-2)  | 100 μm   |
|  |   |  |          | Intumescent paint as per UL 1709. (F-7)<br>Top Coat: Thickness of Fire proofing coating shall be provided by Manufacturer for the desired Fire Rating. | As recommended by Manufacturer<br>Please see Note-3 below. |
| <b><u>Maintenance Protective Coating system no.5</u></b> | Heat resistant paint for flare boom, pedestal crane exhaust<br>120°C to 400 °C. | SSPC-SP-10/ Sa 2 ½   | 40-60 μm | Apply 3 coats of Heat resistant silicon aluminium finish paint. (F-5)  | 20-25 μm (each coat)                                       |
|  |   |  |          | <b>Total DFT:</b>  | <b>60-75 μm</b>  |
| <b><u>Maintenance Protective Coating system no.6</u></b> | Carbon Steel Threaded Joints, Flange Joints, Nuts & Bolts.                      | The surfaces, crevices and corners should be cleaned of rust and dust, loose paint etc. by manual cleaning and compressed air.<br>After cleaning the flange joints, nuts and bolts shall be further protected by <b>anticorrosive polytetrafluoroethylene (PTFE)/Synthetic tapes</b> of size suitable for the flanges and studs of the platform as per recommendation of manufacturer. |          |  | Not Applicable   |

- Note: 1. Paint manufacturers to be asked to provide their best suitable paint as per the scheme made for the environment and as per warranty and paint life required by ONGC.
2. For any coating scheme, all the coats will be from same manufacturers to avoid any compatibility issues.
3. Epoxy Intumescent Coating shall be applied over a suitably primed substrate as per Recommendation of paint manufacturer. Procedure for application shall be as per Manufacture's Quality & application manual. Epoxy Intumescent Coating shall be top coated to meet colour schemes & finish and as per recommendation of paint manufacturer. The fire ratings of Epoxy Intumescent Coating shall be obtained from Certification Agencies like UL, LRS, DNV, BV, etc. and submitted. No hot work shall be carried out after completion of Fire proofing coating.

**13.12 Miscellaneous Accessories**

Three identification boards, with name of the platforms shall be provided on North and South faces of the platforms and on the top of the helideck respectively. The details to be written

|             |               |          |        |            |
|-------------|---------------|----------|--------|------------|
| Format No   | Ref. Proc. No | Issue No | Rev No | Rev. Date  |
| OES/SOF/028 |               | 03       | 00     | 26.02.2018 |





**OFFSHORE  
DESIGN  
SECTION**

**SPECIFICATION FOR  
PROTECTIVE  
COATING**

|                       |            |
|-----------------------|------------|
| SPEC. No.             | 2005       |
| Rev. No.              | 9          |
| Discipline            | Structural |
| No of Pages: 60 of 78 |            |

on the boards shall be approved by the Company. The letters on the boards shall be at least 900 mm in size.

**13.13 Handling and shipping of coated items**

Coated items shall be carefully handled to avoid damage to coated surfaces. No handling shall be performed before the coating system is cured to an acceptable level. Packing, handling and storage facilities shall be of non-metallic type.

**14.0 APPLICATION OF THERMALLY SPRAYED ALUMINIUM COATING (TSAC)**

**14.1 TSAC REQUIREMENTS**

**14.1.1 Surface Preparation**

All the parts to be sprayed shall be degreased according to SSPC-SP 1. The absence of oil and grease after degreasing shall be tested by method given elsewhere in the specification. Thereafter the surface to be abrasive blasted to white metal finish as per NACE 1/SSPC-SP 5 for marine and immersion service. Using SSPC VIS 1, it is to be visually assessed that the blast cleaned surface meets requirement of SSPC-SP 5. Thereafter clear cellophane tape test as per ISO 8502-3 shall be used to confirm absence of dust on the blasted surface. Finally blasted surface shall be tested for presence of soluble salts as per method ISO8502-9. Maximum allowable salt content shall be considered 50mg/M<sup>2</sup>. (5 micrograms/cm<sup>2</sup>) .In case salt content exceeds specified limit, the contaminated surface shall be cleaned by method as per Annex –C of IS 12944-4 (Water Cleaning.) After cleaning the surface shall be retested for salt content after drying.

The blasting media shall be either chilled iron or angular steel grit as per SSPC-AB-3 of mesh size G-16 to G-40. Copper or Nickel slag or Garret as abrasive will also be suitable having mesh size in the range of G16 to G24, conforming to SSPC-AB-1. Mesh size shall be required as appropriate to the anchor tooth depth profile requirement and blasting equipment used. The blasted surface should be having angular profile depth not less than 75 microns with sharp angular shape. The profile depth shall be measured according to NACE standard RP 0287 (Replica Tape) or ASTM D 4417 method B (Profile depth gauge).

For manual blasting one profile depth measurement shall be taken every 10-20 M<sup>2</sup> of blasted surface.

Surface preparation shall be completed in one abrasive blast cleaning operation wherever possible.

If rust bloom (visual appearance of rust) appears on the blast cleaned surface before thermal spraying, the affected area shall be re-blasted to achieve specified degree of cleanliness after which only thermal spraying shall commence. Air blasting pressure at

| Format No   | Ref. Proc. No | Issue No | Rev No | Rev. Date  |
|-------------|---------------|----------|--------|------------|
| OES/SOF/028 |               | 03       | 00     | 26.02.2018 |



|   |  |   |                       |
|---|--|---|-----------------------|
|    | <b>OFFSHORE<br/>DESIGN<br/>SECTION</b> | <b>SPECIFICATION FOR<br/>PROTECTIVE<br/>COATING</b> | SPEC. No. 2005        |
|   |  |   | Rev. No. 9            |
|   |  |   | Discipline Structural |
|   |  |   | No of Pages: 61 of 78 |
| <p>nozzle shall be normally maintained at 100 psi. Air pressure and media size should be reduced and adjusted to preclude damage/distortion to thin gauge materials. Blasting time on work piece should be adjusted to only clean the surface and cut <del>required anchor tooth</del> with minimum loss of metal. Blast angle should be as close to perpendicular as possible but in no case greater than 30° from perpendicular to work surface. Blasting media must be free of debris, excessive fines, contaminants such as NaCl and sulphur salts (Ref. Clause 14.4.6.1 of this spec.).</p> <p><b>14.1.2 Blasting Equipment</b></p> <p>The TSAC applicator shall use mechanical (centrifugal wheel) or pressure pot blast cleaning equipment and procedures. Suction blasting equipment shall not be used. Clause No. 14.4.6.2 shall be used to validate clean and dry air.</p> <p><b>14.1.3 Feed Stock</b></p> <p>The feed stock shall be in the form of wire. The feed stock shall be 99.5% aluminium of commercial purity grade, its composition shall be in accordance with requirement of BS 1475 or ASTM B833 (wrought aluminium and aluminium alloys, wire).</p> <p><b>14.1.4 Thickness Requirement</b></p> <p>The nominal thickness of finished TSAC shall be 225 microns having minimum value of 200 microns at low thickness areas (valleys) and not more than 250 microns at peak areas.</p> <p>The finished thickness shall be measured using SSPC-PA 2 type 2 fixed probe gauge (Magnetic Gauge).</p> <p><b>14.1.5 Coating Bond Strength Requirement</b></p> <p>During CPT coating bond strength requirement shall be as indicated in table 14.2.1.3.</p> <p>The Minimum Tensile Bond Requirements during production shall be 7 Mpa (1000 psi) for any single measurement.</p> <p>The TSC tensile bond shall be measured according to ASTM D 4541 using a self-aligning adhesion tester.</p> <p>For non-destructive measurement: Tensile force shall be measured to the 7Mpa (1000 psi). The tensile force shall then be reduced and the tensile fixture Removed Without damaging the TSAC.</p> <p><b>14.1.6 Porosity</b></p> |  |   |                       |

| Format No   | Ref. Proc. No | Issue No | Rev No | Rev. Date  |
|-------------|---------------|----------|--------|------------|
| OES/SOF/028 |               | 03       | 00     | 26.02.2018 |



**OFFSHORE  
DESIGN  
SECTION**

**SPECIFICATION FOR  
PROTECTIVE  
COATING**

|                       |            |
|-----------------------|------------|
| SPEC. No.             | 2005       |
| Rev. No.              | 9          |
| Discipline            | Structural |
| No of Pages: 62 of 78 |            |

All thermally sprayed metallic coatings will have porosity. For thermally sprayed aluminium coatings porosity shall not exceed 15% of total surface area for flame sprayed coating and 8% for arc spray coating.

**14.2 THERMAL SPRAY APPLICATION PROCEDURE**

Thermally spread Aluminium coating shall be applied by either Flame spray or Arc spray method and shall refer to Clause No. 13.2.1 for application area/zone.

**14.2.1 Equipment set up**

14.2.1.1 Thermal spray equipment shall be set up calibrated, operated (1) according to manufacturer instructions/technical manuals and also TSAC applicators refinement thereto and (2) as validated by Procedure Qualification.

**14.2.1.2 Spray parameters**

Spray parameters and thickness of each crossing pass shall be set and shall be validated with bend test.

**14.2.1.3 Table:**

| Spray Parameters                      | Method of Application                 |  |
|---------------------------------------|---------------------------------------|--|
|                                       | Arc wire Spray                        | Flame Wire Spray                         |
| Arc voltage                           | 27 V                                  | -  |
| Air pressure                          | 80 psi                                | 80 psi                                   |
| Steel surface cleanliness             | NACE-1 white metal                    | NACE-1 white metal / or Near white metal |
| Steel surface profile                 | 75 microns (minimum)                  | 75 microns (min.)                        |
| Arc current                           | 250-280A                              | -  |
| Coating thickness                     | 225 microns (nominal)                 | 225 microns(Nominal)                     |
| Coating adhesion                      | > 1500 psi (Total coating), see 3.1.4 | >1000 psi                                |
| Coating porosity                      | Less than 8%                          | Less than 15%.                           |
| Spray distance (spray Gun work piece) | 6-8"                                  | 5-7"                                     |
| Spray Pass width                      | 40mm                                  | 20 mm                                    |

The above parameters to be validated with a bend test by the contractor before start of work (for detail of Bend Test see clause No. 14.4.5 of this Spec.)

**14.2.2 Post Blasting Substrate condition and thermal spraying period.**

|             |               |          |        |            |
|-------------|---------------|----------|--------|------------|
| Format No   | Ref. Proc. No | Issue No | Rev No | Rev. Date  |
| OES/SOF/028 |               | 03       | 00     | 26.02.2018 |



**OFFSHORE  
DESIGN  
SECTION**

**SPECIFICATION FOR  
PROTECTIVE  
COATING**

|                       |            |
|-----------------------|------------|
| SPEC. No.             | 2005       |
| Rev. No.              | 9          |
| Discipline            | Structural |
| No of Pages: 63 of 78 |            |

14.2.2.1 The steel surface temperature shall be at least 5°C above dew point of ambient air temperature. Steel substrate surface temperature shall be recorded by with a contact pyrometer.

Thermal spraying should commence within 15 minutes from the time of completion of blasting

14.2.2.2 Holding Period

Time between the completion of final anchor tooth blasting and completion of thermal spraying of blasted surface should be no more than four hours.

14.2.3 Pre-Heating

For flame spraying, the initial starting area of 1-2 square feet to be preheated to approx. 120° C to prevent condensation of moisture in the flame on the substrate. For arc spraying the preheating is not required.

14.2.4 Thermal spraying

Spraying should commence only after validation of equipment set up by procedure qualification test and spray parameter validation tests described in Clause No. 14.5 and 14.4.5 respectively. **Thermal spraying must commence within 15 minutes from the time of completion of blast cleaning.**

The specified coating thickness shall be applied in several crossing passes. The coating bond strength is greater when the spray passes are kept thin. Laying down an excessively thick spray pass increases the internal stresses in TSAC and decreases the bond strength of total TSAC. The suitable thickness for crossing passes shall be determined by procedure qualification test.

For manual spraying, spraying to be done in perpendicular crossing passes to minimize thin spots in coating. Approx. 75-100 microns of TSAC shall be laid down in each pass.

The surface geometry of the item or area to be sprayed should be inspected before application. The spraying pass and sequence shall be planned according to following.

- Maintain Gun as close to perpendicular as possible and within ± 30°C from perpendicular to the substrate.
- Maintain nominal stand-off distance and spray pass width as given below:

Table 14.2.4.1:

| Spray method | Standoff (Inches) | Spray pass width (Inches) |
|--------------|-------------------|---------------------------|
| Arc Wire     | 6 – 8             | 1 ½ inch ( 40mm )         |

| Format No   | Ref. Proc. No | Issue No | Rev No | Rev. Date  |
|-------------|---------------|----------|--------|------------|
| OES/SOF/028 |               | 03       | 00     | 26.02.2018 |



**OFFSHORE  
DESIGN  
SECTION**

**SPECIFICATION FOR  
PROTECTIVE  
COATING**

|                       |            |
|-----------------------|------------|
| SPEC. No.             | 2005       |
| Rev. No.              | 9          |
| Discipline            | Structural |
| No of Pages: 64 of 78 |            |

|            |       |                   |
|------------|-------|-------------------|
| Flame wire | 5 – 7 | 3/4 inch ( 20mm ) |
|------------|-------|-------------------|

**14.2.4.1 Rust Bloom (Visual appearance of rust or Discoloration)**

If Rust bloom appears on the blasted surface before thermal spraying, the affected area shall be re-blasted to achieve the specified level of cleanliness.

If Rust bloom in form of discoloration, or any blistering or a degraded coating appears at any time during application of TSAC, then spraying shall be stopped and acceptable sprayed area shall be marked off. The unsatisfactory areas shall be repaired to the required degree of surface cleanliness and profile.

Blast the edges of the TSAC to provide for 2-3" feathered area overlap of the new work into existing TSAC.

Then apply TSAC to the newly prepared surfaces and overlap the existing TSAC to the extent of feathered edge so that overlap is a consistent thickness.

**14.2.4.2 Masking**

Masking all those parts and surfaces which are not required to be thermally sprayed as instructed by purchaser should be inspected by applicator to ensure that they are properly marked and covered by purchaser.

Complex geometries (flanges, valve manifolds, intersections) shall be masked by applicator to minimize overspray i.e. TSAC applied outside spray parameters (primarily gun to substrate distance and spray angle).

**14.2.4.3 TSAC Finish**

The deposited TSAC shall be uniform without blisters, cracks, loose particles, or exposed steel as examined with 10 X magnification.

**14.3 SEALER**

Sealant shall be applied after satisfactory application of TSAC and completion of all testing and measurements of the finished TSAC as per clause No.14.4 of this specification.

For shop work Sealer shall be applied immediately after thermal spraying and for field work sealer shall be applied within 8 hours. The sealcoat shall be thin enough to penetrate into the body of TSAC.

The materials for sealing the metal coating shall be:

- Two-component epoxy for operating temperatures below 120 °C (F-13).
- Aluminium silicone above 120 °C (F-14).

| Format No   | Ref. Proc. No | Issue No | Rev No | Rev. Date  |
|-------------|---------------|----------|--------|------------|
| OES/SOF/028 |               | 03       | 00     | 26.02.2018 |



**OFFSHORE  
DESIGN  
SECTION**

**SPECIFICATION FOR  
PROTECTIVE  
COATING**

|                       |            |
|-----------------------|------------|
| SPEC. No.             | 2005       |
| Rev. No.              | 9          |
| Discipline            | Structural |
| No of Pages: 65 of 78 |            |

Volume solids in the sealers when applied shall be 15 % nominal. The overlay of sealer should be less than 38 µm (1.5 mil) on the TSA coating after application.

The sealer should have a contrasting colour to the TSA to aid visual inspection.

During application of seal coat, complete coverage shall be ensured by visual observation.

**14.4 TESTING AND MEASUREMENT SCHEDULE**

**14.4.1 Surface Finish**

That the blasted cleaned surface meets the required criteria (NACE 1/SSPC-SP 5) shall be visually inspected using SSPC-VIS 1. The clear cellophane-tape test shall be used to confirm absence of dust or foreign debris on the cleaned surface.

**14.4.2 Blast Profile Measurement: (In-Process testing during actual production before application of TSA coating)**

The angular profile depth measurement shall be done by profile tape as per method NACE Standard RP 0287 or ASTM D 4417 method B (Profile depth gauge micrometre). Spot measurement shall be carried out every 15m<sup>2</sup> of blasted surface. At each spot three measurements shall be taken over an area of 10 cm<sup>2</sup> and average of measurements to be recorded and reported.

If profile is <75 microns blasting shall continue till greater than 75 microns depth profile is achieved.

**14.4.3 TSAC Thickness (In-Process Testing For finished coating during regular production)**

**14.4.3.1 TSAC finished thickness shall be measured using SSPC-PA 2 type 2 fixed probe gauge.**

**14.4.3.2** For flat surfaces, measurements shall be taken along a straight measurement line; one measurement line for every 15 m<sup>2</sup> of applied TSAC shall be selected along which 5 measurements to be taken at 25 mm internal and average to be reported.

**14.4.3.3** For curved surface or complex geometry, 5 measurements shall be taken at a spot measuring 10 cm<sup>2</sup> in area. One spot to be taken for every 15 m<sup>2</sup> of applied TSAC area.

**14.4.3.4** The TSAC thickness in surface changes or contour changes, welds and attachments shall be also measured and reported.

**14.4.3.5** If TSAC is less than specified minimum thickness, apply additional TSAC until specified thickness range is achieved.

| Format No   | Ref. Proc. No | Issue No | Rev No | Rev. Date  |
|-------------|---------------|----------|--------|------------|
| OES/SOF/028 |               | 03       | 00     | 26.02.2018 |



**OFFSHORE  
DESIGN  
SECTION**

**SPECIFICATION FOR  
PROTECTIVE  
COATING**

|                       |            |
|-----------------------|------------|
| SPEC. No.             | 2005       |
| Rev. No.              | 9          |
| Discipline            | Structural |
| No of Pages: 66 of 78 |            |

14.4.3.6 All locations and values of TSAC thickness measurements shall be recorded in Job Record (JR).

**14.4.4 Tensile Bond Testing (In-Process testing for finished coating during regular production)**

- Tensile Bond strength of the TSAC finish coat shall be determined according to ASTM D 4541 using a self-aligning adhesion tester.
- One measurement shall be made every 50 m<sup>2</sup>. If tensile bond at any individual spot is less than 1000 psi for flame sprayed coating and 1500 psi for arc sprayed coating the degraded TSAC shall completely remove and reapplied.
- The tensile bond portable test instrument to be calibrated according to ASTM C 633.

**14.4.5 Bend Tests**

Bend test shall be carried out at beginning of each work shift. Bend tests shall also be conducted on sample coupons before start of thermal spraying work to qualify the following as mentioned earlier in this specification.

- To qualify spray parameters and thickness of each crossing pass.

**14.4.5.1 Test Procedure**

- a) Five corrosion control steel coupons each of dimension 50 mm x 150 mm x 1.25 mm thick are to be prepared.
- b) Surface shall be prepared by dry abrasive blast cleaning as per this specification.
- c) TSAC shall be applied as per specified thickness range. TSAC should be sprayed in crossing passes laying down approx. 75-100 microns in each pass.
- d) TSAC applied coupons shall be bent 180° around a 13 mm diameter mandrel.
- e) Bend test shall be considered passed if, on bend radius there is
  - No cracking or spalling or lifting by a knife blade from the substrate.
  - Only minor cracking that cannot be lifted from substrate with a knife blade.
- f) Bend test fails if coating cracks with lifting from substrate.

**14.4.6 Tests for blasting media, blasting air**

**14.4.6.1 Blasting Media (For every fresh batch of media and one random test during blasting)**

| Format No   | Ref. Proc. No | Issue No | Rev No | Rev. Date  |
|-------------|---------------|----------|--------|------------|
| OES/SOF/028 |               | 03       | 00     | 26.02.2018 |



**OFFSHORE  
DESIGN  
SECTION**

**SPECIFICATION FOR  
PROTECTIVE  
COATING**

|                       |            |
|-----------------------|------------|
| SPEC. No.             | 2005       |
| Rev. No.              | 9          |
| Discipline            | Structural |
| No of Pages: 67 of 78 |            |

- a) Blasting Media shall be visually inspected for absence of contamination and debris using 10 X magnification.
- b) Inspection for the absence of oil contamination shall be conducted using following procedure:
  - Fill a small clean 200 ml bottle half full of abrasive.
  - Fill the bottle with potable water, cap and shake the bottle.
  - Inspect water for oil film/slick. If present, the blasting media is not to be used.
- c) Soluble salt contamination if suspected shall be verified by method ASTM D 4940 if present media is to be replaced.
- d) Clean blasting equipment, especially pot and hoses and then replace blasting media and retest.

**14.4.6.2 Test for Blasting Air (Once Daily before start of blasting and once at random during blasting)**

The air for blasting shall be free from moisture and oil. The compressor air shall be checked for oil and water contamination per ASTM D 4285.

**14.4.7 Test for presence of oil/grease and contamination**

The steel substrate after degreasing as per SSPC-SP 1 shall be tested as per following procedure to validate absence of oil and grease contamination.

- a) Visual inspection - Continue degreasing until all visible signs of contamination are removed.
- b) Conduct a solvent evaporation test by applying several drops or a small splash of residue- free trichloromethane on the suspect area especially pitting, crevice corrosion areas or depressed areas. An evaporation ring formation is indicative of oil and grease contamination.

Continue degreasing and inspection till test is passed.

**14.5 TSAC APPLICATOR QUALIFICATION**

Following tests to be carried out as part of procedure qualification test for the applicator.

- Thickness measurement

| Format No   | Ref. Proc. No | Issue No | Rev No | Rev. Date  |
|-------------|---------------|----------|--------|------------|
| OES/SOF/028 |               | 03       | 00     | 26.02.2018 |



|  |  |   |                       |
|--|--|---|-----------------------|
|   | <b>OFFSHORE<br/>DESIGN<br/>SECTION</b> | <b>SPECIFICATION FOR<br/>PROTECTIVE<br/>COATING</b> | SPEC. No. 2005        |
|  |  |   | Rev. No. 9            |
|  |  |   | Discipline Structural |
|  |  |   | No of Pages: 68 of 78 |
| <ul style="list-style-type: none"> <li>- Coating bond strength</li> <li>- Porosity test</li> <li>- Bend strength</li> </ul> <p>TSAC applicator's surface finishing and application process and equipment set up, calibration and operation shall be qualified by application of TSA on a reference sample which shall be used as a comparator to evaluate the suitability of application process. Only that applicator will be permitted to carry out the work when test specimens coated by the applicator meets the desired requirements as cited below.</p> <p>The sample shall be made of a steel plate measuring approx. 18"x 18" x ¼" thick. If the actual work is less than ¼" thick then the sample to be made from material of representative thickness.</p> <p>The surface preparation, TSAC application shall be made with actual field equipments and process/spray parameters and procedures as per the specification. The depth profile of blasted surface, TSAC coating thickness for each cross pass and total thickness range shall be as per specification.</p> <p>The surface preparation and thermal spraying shall be carried out in representative environmental conditions spraying with makeshift enclosure.</p> <p>14.5.1 After application of coating, thickness and tensile bond measurements shall be made in following manner.</p> <ul style="list-style-type: none"> <li>- Divide the sample piece into four quadrants.</li> <li>- Measure thickness along the diagonal line of each quadrant.</li> <li>- Four each quadrant five in-line thickness measurements at 1" interval shall be done using SSPC-PA 2 type 2 fixed probe gauge. Thus a total of four "five in line" thickness measurements are to be done for the whole sample.</li> <li>- One tensile bond measurement using ASTM D 4541 type III or IV portable self-aligning test instrument to be done at centre of each quadrant. Total of 4 measurements for the sample.</li> <li>- One porosity evaluation test by Metallographic examination shall be conducted to demonstrate the achievement of porosity within the limits specified. Sample shall be prepared for Metallographic examination as per ASTM E – 3.</li> <li>- The procedure shall be considered qualified if thickness and tensile bond strength and porosity values meets the specification requirement.</li> </ul> |  |   |                       |

| Format No   | Ref. Proc. No | Issue No | Rev No | Rev. Date  |
|-------------|---------------|----------|--------|------------|
| OES/SOF/028 |               | 03       | 00     | 26.02.2018 |





**OFFSHORE  
DESIGN  
SECTION**

**SPECIFICATION FOR  
PROTECTIVE  
COATING**

|                       |            |
|-----------------------|------------|
| SPEC. No.             | 2005       |
| Rev. No.              | 9          |
| Discipline            | Structural |
| No of Pages: 69 of 78 |            |

14.5.2 Bend test: Bend test shall be carried out as detailed at Clause No. 14.4.5 of this specification.

- Applicators thermal spray equipment set-up, operation and procedure of application including in-process QC checkpoints adopted during procedure qualification as described above should be always subsequently followed during entire duration of work.

#### 14.6 Documentation

The following information shall be provided by TSAC applicator before award of work.

- TSAC application process consisting of equipment capabilities and their technical parameters, feed stock material and source of procurement.
- Detailed application procedure and in-process quality control check points for (a) surface preparation (b) thermal spraying (c) seal coats.
- Type and specification of instruments to be deployed for measurement of blast profile depth, TSAC thickness and tensile bond.
- Paint manufacturer data sheet for the selected sealing coat to be applied.

#### 14.7 RECORDS

- The TSAC applicator shall maintain job record to record production and QC information. All the results of the tests and quality control checks shall be entered in the record for each component/part thermally sprayed. All the result of tests (thickness, tensile bond, bend tests) and other validation tests (e.g. procedure qualification test, test for surface cleanliness after abrasive blasting, test for cleanliness of abrasives and air) shall also be recorded and duly signed by owner.
- All the information mentioned in Clause no.14.6 above should also form part of the Job record.
- Any modification affected after procedure qualification in the procedure, QC, spray parameter, equipment spec to the original information (submitted before award of the work) must also form part of Job record.

#### 14.8 WARRANTY

The TSAC applicator shall warrant the quality of material used by providing the purchaser with a certificate of materials used to include

| Format No   | Ref. Proc. No | Issue No | Rev No | Rev. Date  |
|-------------|---------------|----------|--------|------------|
| OES/SOF/028 |               | 03       | 00     | 26.02.2018 |



**OFFSHORE  
DESIGN  
SECTION**

**SPECIFICATION FOR  
PROTECTIVE  
COATING**

|                       |            |
|-----------------------|------------|
| SPEC. No.             | 2005       |
| Rev. No.              | 9          |
| Discipline            | Structural |
| No of Pages: 70 of 78 |            |

- Spray feed stock: Alloy type/designation, Lot Number, wire diameter, chemical analysis, name of supplier, manufacturer.
- Sealant: Name of manufacturer, application data sheet.

**14.9 SAFETY**

The TSAC applicator shall follow all safety procedures required by the purchaser/owner. Owner shall also give compliance requirement to be followed by applicator. The applicator shall follow all appropriate regulatory requirements.

**14.10 CODES AND STANDARDS**

This specification shall apply in case of conflict between specification and following applicable Codes & Standard:

|                                |  |
|--------------------------------|--|
| AWS C.2.17                     | Recommended Practice for Electric arc Spray.   |
| ASTM C 633                     | Test Method for Adhesive/Cohesive Strength of Flame Sprayed Coatings.  |
| ASTM D 4285                    | Method for indicating Oil or Water in Compressed Air.  |
| ASTM D 4417                    | Test Method for Field Measurement of Surface Profile of Blasted Steel.   |
| BS 2569                        | Specification for Sprayed Metal Coating.   |
| NACE Standard RP 0287          | Field Measurement of Surface Profile of Abrasive Blast Cleaned Steel Surfaces Using a Replica Tape.  |
| ASTM D 4541                    | Test method for Pull-Off Strength of Coating Using Portable Adhesion Testers.  |
| ANSI/AWS C2.18                 | Guide for the Protection of Steel with Thermal Spray Coatings of Aluminium, Zinc and Their Alloys and Composites.  |
| NACE No. 12/AWS C2.23M/SSPC-CS | Specification for the application of thermal spray coatings (Metallizing) of aluminium, zinc, and their alloys and composites for the corrosion protection of steel. |
| SSPC Publication               | The inspection of coatings and linings: A Handbook of Basic practice for Inspectors, Owners, and Specifiers.   |
| SSPC-AB 1                      | Mineral and Slag Abrasives.  |
| SSPC-AB 3                      | Ferrous Metallic Abrasives.  |
| SSPC-PA 1                      | Shop, Field, and Maintenance Painting of Steel.  |
| SSPC-PA 2                      | Measurement of Dry Coating Thickness with Magnetic Gages.  |
| NACE No. 1/SSPC-SP 5           | White Metal Blast Cleaning.  |
| NACE No. 2/SSPC-SP 10          | Near -White Metal Blast Cleaning.  |

|             |               |          |        |            |
|-------------|---------------|----------|--------|------------|
| Format No   | Ref. Proc. No | Issue No | Rev No | Rev. Date  |
| OES/SOF/028 |               | 03       | 00     | 26.02.2018 |



**OFFSHORE  
DESIGN  
SECTION**

**SPECIFICATION FOR  
PROTECTIVE  
COATING**

|                       |            |
|-----------------------|------------|
| SPEC. No.             | 2005       |
| Rev. No.              | 9          |
| Discipline            | Structural |
| No of Pages: 71 of 78 |            |

|            |   |
|------------|---|
| SSPC-VIS 1 | Guide and Reference Photographs for Steel Surfaces Prepared by Dry Abrasive Blast Cleaning. |
|------------|---|

**14.11 Suggested List of TSA applicators**

- 1) Metallizing Equipment Corporation, Jodhpur, India
- 2) Larsen & Toubro Ltd (Eutectic division), New Delhi, India
- 3) Chemtreat India Ltd, Navi Mumbai, India
- 4) Deepwater MPE, Malaysia
- 5) Associated Thermal Spray, Ahmedabad, India
- 6) M/S PS Coatings Pvt. Ltd, New Mumbai, India
- 7) M/S NPCC, Abu Dhabi
- 8) M/S McDermott, Jebel Ali, Dubai
- 9) M/S PTSC, Vietnam

TSAC coating shall be applied to bottom of bridge including bottom of deck plating of bridge & piping.

Other applicators will also be acceptable if they qualify the applicator qualification procedure given in the specification. If any one of the above suggested applicator is selected, even then he has to perform the qualification test before commencing of the work.

**15.0 COLOUR SCHEDULE**

**15.1 Table No.**

| Sr. No.  | Item to be Painted                                     | Finish Coat Colour             | Colour Code No. |
|----------|--|--------------------------------|-----------------|
| <b>A</b> | <b>SPLASH ZONE</b>                                     |                                |                 |
| 1        | All areas coated with XHB Glass flake reinforced Epoxy | Golden Yellow                  | RAL 1004        |
| 2        | Handrails & Ladders                                    |                                |                 |
| <b>B</b> | <b>ATMOSPHERIC ZONE-I &amp; II</b>                     | Golden Yellow                  | RAL 1004        |
| 1        | All areas coated with System 2 (Structural steelwork)  | Golden Yellow                  | RAL 1004        |
| 2        | Handrails and ladders                                  | Golden Yellow                  | RAL 1004        |
| 3        | Buildings (outside surfaces)                           | Spanish Tile Red               | RAL 3000        |
| 4        | Overhead Obstructions                                  | Golden Yellow with Black Strip | RAL 1004 &      |

|             |               |          |        |            |
|-------------|---------------|----------|--------|------------|
| Format No   | Ref. Proc. No | Issue No | Rev No | Rev. Date  |
| OES/SOF/028 |               | 03       | 00     | 26.02.2018 |



**OFFSHORE  
DESIGN  
SECTION**

**SPECIFICATION FOR  
PROTECTIVE  
COATING**

|                       |            |
|-----------------------|------------|
| SPEC. No.             | 2005       |
| Rev. No.              | 9          |
| Discipline            | Structural |
| No of Pages: 72 of 78 |            |

|          |  |  |                          |
|----------|--|--|--------------------------|
|          |  |  | RAL 9012                 |
| 5        | Helideck top surface (marking colour shall be as per CAP437 ,(7 <sup>th</sup> Edition ) guideline) | Dark Green                             | RAL 6020                 |
| 6        | Walkway of Helideck  | Dark Green with White side strips      | RAL 6020+<br>RAL NO.9010 |
| <b>C</b> | <b>EQUIPMENT, PIPING AND TUBING</b>  | Natural Grey                           | RAL 7038                 |
| 1        | Pumps and Drivers  | Dark Grey or Factory Finish            | RAL 7039                 |
| 2        | Compressors and Drivers  | Dark Grey or Factory Finish            | RAL 7039                 |
| 3        | Generators and Drivers   | Dark Grey or Factory Finish            | RAL 7039                 |
| 4        | Water Makers   | Light Blue or Factory Finish           | RAL 5012                 |
| 5        | Tanks and Vessels  | White                                  | RAL 9003                 |
| 6        | Electrical Equipment incl. Cable Trays   | Aluminium Grey                         | RAL 9007                 |
| 7        | Electrical Danger Points   | Orange                                 | RAL 2004                 |
| 8        | Instrumentation  | Factory Finish                         | -----                    |
| 9        | Fire Fighting Equipment  | Red                                    | RAL 3000                 |
| 10       | First Aid Equipment  | Signal Green                           | RAL 6032                 |
| 11       | Risers and J Tubes   | Aluminium Grey                         | RAL 9007                 |
| 12       | Process Piping Systems   | Refer Table 15.2 of this specification |                          |

The name tag no. and service of all equipment should be stencilled in capital letters 40 – 50 mm in height on the equipment. The Colour shall be black or white and in contrast to the colour on which the lettering is superimposed.

**15.2 Pipe Colour Coding**

All piping shall be colour coded to identify service in accordance with the following criteria. The colour coding shall comply with the schedule in Table 15.

**TABLE No. 15.2: PIPE COLOUR CODING (PROCESS) COLOUR SCHEME FOR PRODUCT BEING PROCESSED**

| Sr. No.      | Description | Colour code Identification           |   |
|--------------|-------------|--------------------------------------|---|
|              |             | Base/Ground Colour (Colour code no.) | Colour Bands<br>1)1 <sup>st</sup> Band 2)2 <sup>nd</sup> Band |
| <b>GASES</b> |             |                                      |   |
| 1            | Sour Gas    | Canary Yellow (RAL NO.1012)          | 1)Grey(RAL NO.7000)<br>2)Dark Violet (RAL NO.5022)            |
| 2            | Sweet Gas   | Canary Yellow (RAL NO.1012)          | Grey (RAL NO.7000)  |

|             |               |          |        |            |
|-------------|---------------|----------|--------|------------|
| Format No   | Ref. Proc. No | Issue No | Rev No | Rev. Date  |
| OES/SOF/028 |               | 03       | 00     | 26.02.2018 |



**OFFSHORE  
DESIGN  
SECTION**

**SPECIFICATION FOR  
PROTECTIVE  
COATING**

|                       |            |
|-----------------------|------------|
| SPEC. No.             | 2005       |
| Rev. No.              | 9          |
| Discipline            | Structural |
| No of Pages: 73 of 78 |            |

|   |                 |                             |  |
|---|-----------------|-----------------------------|--|
| 3 | Fuel Gas        | Canary Yellow (RAL NO.1012) | 1)Light Brown(RAL NO.8025)<br>2)White(RAL NO.9010) |
| 4 | Residue         | Canary Yellow (RAL NO.1012) | 1)Oxide Red(RAL NO.3009)<br>2)White(RAL NO.9010)   |
| 5 | Flare Gas       | Canary Yellow (RAL NO.1012) | Aluminum(RAL NO.9006)                              |
| 6 | Regenerated Gas | Canary Yellow (RAL NO.1012) | 1)White(RAL NO.9010)<br>2)Dark Violet(RAL NO.5022) |

**LIQUIDS**

|   |                          |                                   |  |
|---|--------------------------|-----------------------------------|--|
| 1 | Crude Oil                | Light Brown (RAL NO.8025)         | No Band  |
| 2 | High Speed Diesel        | Light Brown (RAL NO.8025)         | 1)Brilliant Green(RAL NO.6038, 6017)<br>2)White(RAL NO.9010) |
| 3 | Hydrocarbon Condensate   | Dark Admiralty Grey(RAL NO.7031)  | 1)Signal Red (RAL NO.3020)<br>2)Black(RAL NO.9005)           |
| 4 | Chlorine                 | Dark Violet(RAL NO.5022)          | Signal Red(RAL NO.3020)                                      |
| 5 | Triethylene Glycol (TEG) | Dark Admiralty Grey (RAL NO.7031) | 1)Sea Green (RAL NO.6018)<br>2)Yellow (RAL NO.1003)          |
| 6 | Oily Water               | Black (RAL NO.9005)               | No Band  |
| 7 | Dosing Chemical          | Dark Admiralty Grey (RAL NO.7031) | No Band  |
| 8 | ATF                      | Dark Admiralty Grey(RAL NO.7031)  | Black(RAL NO.9005)   |

**UTILITY ITEMS: WATER**

|   |                              |                         |   |
|---|------------------------------|-------------------------|---|
| 1 | Drinking Water               | Sea Green (RAL NO.6018) | 1)French Blue (RAL NO.5002)<br>2)Signal Red(RAL NO.3020)    |
| 2 | Domestic Hot Water           | Sea Green (RAL NO.6018) | Light Green(RAL NO.6021)                                    |
| 3 | Cold Water from Storage Tank | Sea Green (RAL NO.6018) | 1)French Blue (RAL NO.5002)<br>2)Canary Yellow(RAL NO.1012) |
| 4 | Demineralized Water          | Sea Green (RAL NO.6018) | Gulf Red(RAL NO.8019)                                       |
| 5 | Cooling Water                | Sea Green (RAL NO.6018) | French Blue (RAL NO.5002)                                   |
| 6 | Condensate Water             | Sea Green (RAL NO.6018) | 1)Light Brown (RAL NO.3009)<br>2)Signal Red(RAL NO.3020)    |
| 7 | Wash Water                   | Sea Green(RAL NO.6018)  | Canary Yellow(RAL NO.1012)                                  |
| 8 | Fire water                   | Fire Red(RAL NO.3000)   | Crimson Red(RAL NO.3007)                                    |

|             |               |          |        |            |
|-------------|---------------|----------|--------|------------|
| Format No   | Ref. Proc. No | Issue No | Rev No | Rev. Date  |
| OES/SOF/028 |               | 03       | 00     | 26.02.2018 |



**OFFSHORE  
DESIGN  
SECTION**

**SPECIFICATION FOR  
PROTECTIVE  
COATING**

|                       |            |
|-----------------------|------------|
| SPEC. No.             | 2005       |
| Rev. No.              | 9          |
| Discipline            | Structural |
| No of Pages: 74 of 78 |            |

|    |                     |                         |   |
|----|---------------------|-------------------------|---|
| 9  | Sea Untreated water | Sea Green(RAL NO.6018)  | White(RAL NO.9010)  |
| 10 | Waste Water         | Sea Green (RAL NO.6018) | 1)Canary Yellow(RAL NO.1012)<br>2)Signal Red(RAL NO.3020) |
| 11 | Treated Water       | Sea Green (RAL NO.6018) | Light Orange(RAL NO.2003)                                 |

**UTILITY ITEMS: COMPRESSOR**

|   |                                   |                        |                          |
|---|-----------------------------------|------------------------|--------------------------|
| 1 | Compressed Air (upto 15kg/sq.cm)  | Sky Blue (RAL NO.5015) | -----                    |
| 2 | Compressed Air (above 15kg/sq.cm) | Sky Blue(RAL NO.5015)  | Signal Red(RAL NO.3020)  |
| 3 | Plant Air                         | Sky Blue(RAL NO.5015)  | Silver Grey(RAL NO.7001) |
| 4 | Instrument Air                    | Sky Blue(RAL NO.5015)  | French Blue(RAL NO.5002) |
| 5 | Drainage                          | Black(RAL NO.9005)     | -----                    |

**UTILITY ITEMS: OILS**

|   |                 |                          |                          |
|---|-----------------|--------------------------|--------------------------|
| 1 | Lubricating Oil | Light Brown(RAL NO.8025) | Light Grey(RAL NO.7004)  |
| 2 | Hydraulic Power | Light Brown(RAL NO.8025) | Dark Violet(RAL NO.5022) |

**UTILITY ITEMS: GASES**

|   |                 |                             |                            |
|---|-----------------|-----------------------------|----------------------------|
| 1 | Acetylene       | Canary Yellow (RAL NO.1012) | Service Brown(RAL NO.8022) |
| 2 | Nitrogen        | Canary Yellow(RAL NO.1012)  | Black(RAL NO.9005)         |
| 3 | Oxygen          | Canary Yellow(RAL NO.1012)  | White(RAL NO.9010)         |
| 4 | Carbon di Oxide | Canary Yellow(RAL NO.1012)  | Light Grey(RAL NO.7004)    |

Note: Any product which is not covered will be governed as per colour code standard IS: 2379/other standard under reference.

**15.3 Colour Bands for Identification & Size of pipe**

**15.3.1 Identification & Size**

The Width of colour band shall confirm to the following (As per IS 2379)

| Sr. No. | Nominal Pipe Size | Width : L (mm) |
|---------|-------------------|----------------|
| 1       | 80NB and below    | 25             |

|             |               |          |        |            |
|-------------|---------------|----------|--------|------------|
| Format No   | Ref. Proc. No | Issue No | Rev No | Rev. Date  |
| OES/SOF/028 |               | 03       | 00     | 26.02.2018 |



**OFFSHORE  
DESIGN  
SECTION**

**SPECIFICATION FOR  
PROTECTIVE  
COATING**

|                       |            |
|-----------------------|------------|
| SPEC. No.             | 2005       |
| Rev. No.              | 9          |
| Discipline            | Structural |
| No of Pages: 75 of 78 |            |

|   |                         |     |
|---|-------------------------|-----|
| 2 | Over 100 NB upto 150 NB | 50  |
| 3 | Over 200 NB upto 300 NB | 75  |
| 4 | Over 350 NB             | 100 |

The relative proportional width of first colour band to be subsequent bands shall be 4:1. Maximum stripe spacing shall be 150mm

### 15.3.2 Application

Color Bands shall be applied at the following location as per # 7.3 of IS: 2379

- Battery Limit points
- Intersection point and change of direction points in piping ways
- Other point such as midway of each piping way, near valves, junction joints of service appliances, walls on either side of pipe culverts
- For long stretch yard piping at 50 m interval and at start and terminating points

Color bands shall be arranged in the sequence shown in table below and sequence follows the direction of flow.

For Insulation pipes, nominal pipe size means the outside diameter of insulation.

### 15.4 Colour of Valves

The Valves shall be painted as per As per IS: 2379

Table No. 15.4

| Sr. No. | Condition  | Colour of Valves  |
|---------|--|---|
| 1       | Valves on Fire fighting                                  | Red (RAL NO.3000)   |
| 2       | Valves on Pipe carrying Hazardous Material               | Golden Yellow with black strips (RAL NO.1004) & (RAL NO.9005) |
| 3       | Valves on Water carrying piping (Potable or Non-Potable) | French Blue(RAL NO.5002)                                      |
| 4       | All Other Piping   | Same colour as the main piping                                |

### 15.5 SIZE OF FLOW DIRECTION ARROWS

Pipes shall be marked with arrow to indicate flow direction as per the isometrics. Arrow markers shall be placed at starting / termination point of piping above each floor generation at a height of about 1.5m from floors. The service or the origin place shall also be marked in the same colour, stenciled in capital letters 40 - 50 mm in height. The colour or arrow shall be black or white and in contrast to the colour on which they are superimposed. The arrow indicating flow

|             |               |          |        |            |
|-------------|---------------|----------|--------|------------|
| Format No   | Ref. Proc. No | Issue No | Rev No | Rev. Date  |
| OES/SOF/028 |               | 03       | 00     | 26.02.2018 |



**OFFSHORE  
DESIGN  
SECTION**

**SPECIFICATION FOR  
PROTECTIVE  
COATING**

|                       |            |
|-----------------------|------------|
| SPEC. No.             | 2005       |
| Rev. No.              | 9          |
| Discipline            | Structural |
| No of Pages: 76 of 78 |            |

directions as per piping isometrics shall be marked on both sides of the pipe 180 deg. apart at an interval of 3 to 6 meters or less depending on pipe length.

Size (in mm) of the arrow shall be either of the following:



**15.6 Colour Schedule for Fire Fighting Equipment:**

Fire Equipment/ Fire Fighting Equipment colour shall be in accordance with following criteria as detailed in table 15.6

Table No. 15.6

| Sr. No. | Item/Application   | Standard Painting Color  | RAL No.                         |
|---------|--|--|---------------------------------|
| 1       | A. Extinguishers: Water based, foam, DCP, CO2  | Fire red Paint   | (RAL NO.3000)                   |
|         | B. all fire tenders /jeep, fire engines(except foam tank, foam piping & nitrogen cylinder) |  |                                 |
|         | C. Fire tender, water piping/wet risers. Fire hose reel box                                |  |                                 |
|         | D. Fire tender water pump & engine/water pipeline in engine & pump                         |  |                                 |
|         | E. DCP tank & DCP piping   |  |                                 |
| 2       | Foam tank & foam piping/nitrogen cylinder  | Dark Admiralty Grey  | (RAL NO.7031)                   |
| 3       | Driver compartment & inside of the lockers   | Pale Cream   | (RAL NO.9001)                   |
| 4       | Chassis & wheel arches   | Black  | (RAL NO.9005)                   |
| 5       | Fire services insignia & identity nomenclatures  | Canary yellow with black border on sides of sides of the vehicle/equipment | (RAL NO. 1012) & (RAL NO. 9005) |

**16.0 RECOMMENDED LIST OF PAINT MANUFACTURERS**

Refer updated Vendor List in ONGC Website.

|             |               |          |        |            |
|-------------|---------------|----------|--------|------------|
| Format No   | Ref. Proc. No | Issue No | Rev No | Rev. Date  |
| OES/SOF/028 |               | 03       | 00     | 26.02.2018 |





**OFFSHORE  
DESIGN  
SECTION**

**SPECIFICATION FOR  
PROTECTIVE  
COATING**

|                       |            |
|-----------------------|------------|
| SPEC. No.             | 2005       |
| Rev. No.              | 9          |
| Discipline            | Structural |
| No of Pages: 77 of 78 |            |

**17.0 PROCEDURE FOR APPROVAL OF NEW COATING MATERIAL**

Following procedure recommended is to be followed for approval materials Manufactured by new manufactures (indigenous and foreign):

1. The manufacturer should arrange testing of the coating materials as per the List of tests given in para 5 below from one of the reputed Government Laboratories.
2. Samples of coating materials should be submitted to the Govt. Laboratory in sealed containers with batch number and test certificate on regular format of manufacturer's testing laboratory.
3. All test panels should be prepared by the Govt. testing agency-colored photographs of test panels should be taken before and after the test and should be enclosed along with test report.
4. Sample batch number and manufacturers test certificate should be enclosed along with the report. Test report must contain detail of observations and rating if any as per the testing code. Suggested Govt. laboratories are:

RRL, Hyderabad

HBTI, Kanpur

DMSRDE, Kanur

IIT, Bombay

BIS, Laboratories

UDCT, Mumbai

Or Other International Test houses of Repute to be approved by the Company.

5. Manufacturers should intimate the company, details of sample submitted for testing, name of Govt. testing agency, date. Contact personnel of the Govt. testing agency. At the end of the test the manufacturer should submit the test reports to the Company for approval. The manufacturer(s) shall be qualified based on the results of these tests and the Company's decision in this regard -shall be Final and binding on the manufacturer. All tests required for evaluation of acceptance coating materials for offshore application shall be as per the relevant ASTM standards.

**18.0 PAINT PERFORMANCE GUARANTEE OF PROTECTIVE COATING:**

| Format No   | Ref. Proc. No | Issue No | Rev No | Rev. Date  |
|-------------|---------------|----------|--------|------------|
| OES/SOF/028 |               | 03       | 00     | 26.02.2018 |



**OFFSHORE  
DESIGN  
SECTION**

**SPECIFICATION FOR  
PROTECTIVE  
COATING**

|                       |            |
|-----------------------|------------|
| SPEC. No.             | 2005       |
| Rev. No.              | 9          |
| Discipline            | Structural |
| No of Pages: 78 of 78 |            |

Contractor shall provide performance Guarantee for protective coating for the period as specified in Volume – I of Bid Document.

----END----

| Format No   | Ref. Proc. No | Issue No | Rev No | Rev. Date  |
|-------------|---------------|----------|--------|------------|
| OES/SOF/028 |               | 03       | 00     | 26.02.2018 |



**OFFSHORE  
DESIGN  
SECTION**

**FUNCTIONAL  
SPECIFICATION FOR  
CATHODIC  
PROTECTION SYSTEM  
FOR SUBMARINE  
PIPELINE**

|                   |                |
|-------------------|----------------|
| <b>SPEC. No.</b>  | <b>FS 4002</b> |
| <b>Rev. No.</b>   | <b>9</b>       |
| <b>Discipline</b> | <b>Elect</b>   |
| Page: 1 of 13     |                |

**FUNCTIONAL SPECIFICATION  
OF  
CATHODIC PROTECTION SYSTEM  
FOR SUBMARINE PIPELENE**

| <b>PREPARED /<br/>REVISED<br/>BY</b> | <b>REVIEWED<br/>BY</b> | <b>APPROVED BY</b> | <b>TOTAL NO. OF<br/>PAGES</b> | <b>DATE</b>       | <b>REV.</b> |
|--------------------------------------|------------------------|--------------------|-------------------------------|-------------------|-------------|
| <b>P.Kumar</b>                       | <b>K.Rajamouly</b>     | <b>A.Sezhian</b>   | <b>13</b>                     | <b>29-07-2016</b> | <b>9</b>    |

| <b>Format No</b>    | <b>Ref. Proc. No</b>      | <b>Issue No</b> | <b>Rev No</b> | <b>Rev. Date</b>  |
|---------------------|---------------------------|-----------------|---------------|-------------------|
| <b>ODS/SOF/004A</b> | <b>ODS/SOP/008 to 015</b> | <b>01</b>       | <b>01</b>     | <b>15/10/2003</b> |



**OFFSHORE  
DESIGN  
SECTION**

**FUNCTIONAL  
SPECIFICATION FOR  
CATHODIC PROTECTION  
SYSTEM FOR SUBMARINE  
PIPELINE**

**SPEC. No. FS 4002**

**Rev. No. 9**

**Discipline Elect**

Page: 2 of 13

## CONTENTS

- 1.0 SCOPE
- 2.0 TECHNICAL REQUIRMENTS
- 3.0 ANODE MATERIAL
- 4.0 TESTING & INSPECTION
- 5.0 ANODE DIMENSIONS AND PHYSICAL CHARACTERISTICS
- 6.0 ANODE INSTALLATION
- 7.0 SERVICE AFTER INSTALLATION
- 8.0 ELECTRICAL CONTINUITY AND RESISTANCE TESTS FOR PIPELINES.
- 9.0 WARRENTY
- 10.0 VENDOR PREQUALIFICATION
- 11.0 VENDOR DATA REQUIRMENTS
- 12.0 PACKING AND TRANSPORTATIONS

| Format No    | Ref. Proc. No      | Issue No | Rev No | Rev. Date  |
|--------------|--------------------|----------|--------|------------|
| ODS/SOF/004B | ODS/SOP/008 to 015 | 01       | 01     | 15/10/2003 |

|   |  |   |                          |
|---|--|---|--------------------------|
|  | <b>OFFSHORE<br/>DESIGN<br/>SECTION</b> | <b>FUNCTIONAL<br/>SPECIFICATION FOR<br/>CATHODIC PROTECTION<br/>SYSTEM FOR SUBMARINE<br/>PIPELINE</b> | <b>SPEC. No.</b> FS 4002 |
|   |  |   | <b>Rev. No.</b> 9        |
|   |  |   | <b>Discipline</b> Elect  |
|   |  |   | Page: 3 of 13            |

## 1. SCOPE

This specification defines the functional requirements for the material selection, design, manufacture, supply and installation of a sacrificial type unmonitored cathodic protection system for submarine pipelines, and risers in case of rigid lines and I/J tubes in case of flexible lines.

### 1.1 SCOPE OF SUPPLY

The scope of supply through this specification includes:

- Sacrificial anodes, cables and accessories etc. for cathodic protection of rigid pipelines and risers
- Or**
- Sacrificial anodes, cables and accessories etc. for cathodic protection of flexible pipelines and I/J Tubes

### CODES & STANDARDS

Design and installation of the cathodic protection system shall be in accordance with good marine practice in corrosion protection and compliance with the latest revisions of following Codes & Standards:

NACE RP 0387-99 : National Association of Corrosion Engineers  
NACE RP 0492-92  
ASTM A 36 : American Society of Testing of Materials.  
DNV RP-F-103 : Det Norske Veritas.  
DNV RPB 401  
ISO 15589-2 : International standards organization  
Any other international standard or code may be used in lieu of the above with prior approval of the Company.

## 2.0 TECHNICAL REQUIREMENTS

### 2.1 General

Cathodic protection system shall be made up of anodes with a configuration and anodic material composition suitable for use in seawater. All raw materials finished products and components of the CP system specified herein shall be new and unused, of current manufacture, of highest grade and free from all defects and imperfections that could adversely affect the performance of the system.

|              |                    |          |        |            |
|--------------|--------------------|----------|--------|------------|
| Format No    | Ref. Proc. No      | Issue No | Rev No | Rev. Date  |
| ODS/SOF/004B | ODS/SOP/008 to 015 | 01       | 01     | 15/10/2003 |



OFFSHORE  
DESIGN  
SECTION

FUNCTIONAL  
SPECIFICATION FOR  
CATHODIC PROTECTION  
SYSTEM FOR SUBMARINE  
PIPELINE

|               |         |
|---------------|---------|
| SPEC. No.     | FS 4002 |
| Rev. No.      | 9       |
| Discipline    | Elect   |
| Page: 4 of 13 |         |

## 2.2 Design Criteria:

The cathodic protection system for the submarine pipelines and risers shall be designed in accordance with the requirements of this specification and DNV RP-F-103. However, parameters/values mentioned in this specification shall be used in calculations irrespective of any parameters/ values mentioned in any codes, standards or recommended practices.

The sacrificial anode shall be Galvalum-III or equivalent mercury free Al-Zn-In alloy.

The following cathodic current densities and driving potentials shall be considered by bidders for design and evaluation of CP system.

- **CD in sea water: 100 ma/m<sup>2</sup>**
- **CD (buried pipeline) : 50 ma/m<sup>2</sup>**
- **Driving potentials ( initial and near end life ):250mv.**
- **Driving potentials ( mid life ):150mv.**

*For pipelines carrying hot fluids, the current density values shall be increased by 1mA/m<sup>2</sup> per degree Celsius of operating fluid temperature. The temperature difference to be considered for the purpose shall be the difference of operating fluid temperature and 25° C.*

*For calculation of Anode mass, electrochemical efficiency shall be taken as given in Table 1. For operating fluid temperatures between the limits stated, the electrochemical efficiencies shall be linearly interpolated.*

| Operating Fluid Temperature | Non buried P/L<br>Ah/Kg | Buried P/L<br>Ah/Kg |
|-----------------------------|-------------------------|---------------------|
| < = 30 C                    | 2000                    | 2000                |
| 60 C                        | 2000                    | 850                 |
| 80 C                        | 900                     | 400                 |

| Format No    | Ref. Proc. No      | Issue No | Rev No | Rev. Date  |
|--------------|--------------------|----------|--------|------------|
| ODS/SOF/004B | ODS/SOP/008 to 015 | 01       | 01     | 15/10/2003 |

|   |  |   |                          |
|---|--|---|--------------------------|
|  | <b>OFFSHORE<br/>DESIGN<br/>SECTION</b> | <b>FUNCTIONAL<br/>SPECIFICATION FOR<br/>CATHODIC PROTECTION<br/>SYSTEM FOR SUBMARINE<br/>PIPELINE</b> | <b>SPEC. No.</b> FS 4002 |
|   |  |   | <b>Rev. No.</b> 9        |
|   |  |   | <b>Discipline</b> Elect  |
|   |  |   | Page: 5 of 13            |

2.2.1 Design Life : As per data sheet

2.2.2 *Average coating breakdown factor for pipeline and field joint together shall be considered as 5% for coal tar enamelled (CTE) coated pipes and 2 % for 3LPE/ PP coated pipes.*

2.2.3 Technical Requirements :

**RIGID PIPELINES:**

- Tapered anodes shall not be acceptable for concrete coated rigid pipelines
- *In case of rigid pipelines, anode spacing shall be half of that calculated using design parameters, for the following case and additional anodes shall be provided accordingly*
  - *At the platform ends, for the first 200 metres length of the pipeline measured from the bottom of the monel sheathing in the riser pipe.*
- For pipeline crossings, a barrier of minimum 350 mm shall be maintained by mattresses, grout bag etc.
- The anodes for risers can be accommodated in the adjacent pipeline section when both the riser and Pipeline are supplied and installed under the same contract.
- For pipelines carrying hot fluids, the entire length of the pipeline may be divided into number of sections. The temperature to be taken for each section of the pipeline shall be the temperature at the upstream of the particular section of the pipeline calculated from the temperature gradient analysis. For temperature at originating point of the pipeline segment, the operating fluid temperature shall be taken for calculation purposes.
- In case of water injection pipelines, the anode temperature to be considered for the purpose of anode design shall be 30°C both for pipeline and riser segments. However, for the pipelines carrying hot fluids the temperatures considered shall be the same as fluid temperature.
- In case of rigid pipelines where operating fluid temperature is more than 80°C, the anodes shall be thermally insulated from the pipeline using suitable material.
- In case of rigid pipelines, the submerged area of monel sheathing shall also be considered for the purpose of CP system design.

| Format No    | Ref. Proc. No      | Issue No | Rev No | Rev. Date  |
|--------------|--------------------|----------|--------|------------|
| ODS/SOF/004B | ODS/SOP/008 to 015 | 01       | 01     | 15/10/2003 |

|   |  |   |                          |
|---|--|---|--------------------------|
|  | <b>OFFSHORE<br/>DESIGN<br/>SECTION</b> | <b>FUNCTIONAL<br/>SPECIFICATION FOR<br/>CATHODIC PROTECTION<br/>SYSTEM FOR SUBMARINE<br/>PIPELINE</b> | <b>SPEC. No.</b> FS 4002 |
|   |  |   | <b>Rev. No.</b> 9        |
|   |  |   | <b>Discipline</b> Elect  |
|   |  |   | Page: 6 of 13            |

The submerged area of monel sheathing is defined as  
Lower limit : bottom of the monel sheathing  
Upper limit : Average of astronomical tide and storm surge  
defined in pipeline design criteria.

Further, the submerged area of the monel sheathing shall be treated as bare steel surface with 100% coating breakdown while calculating the current requirements.

#### **FLEXIBLE PIPELINES:**

The Cathodic Protection requirement are to be read in conjunction with description of work and specification FS 2020E for flexible pipeline given else where in the bid document.

The vendor shall consider anodes for surface area as 1% of the total length of the flexible pipeline for a period of five years and end fittings for the service life of the pipe for flexible pipeline CP system design. The anodes thus calculated shall be put at/near to the end fittings.

The end fittings, which shall always remain in contact with the corrosive environment, shall be provided with sacrificial anodes for cathodic protection. These anodes shall be electrically connected to the pipe end fitting which shall have electrical continuity with the tensile armours.

### **3.0 Anode Material**

Anodes shall be GALVALUM-III or Equivalent (Al-Zn-In) alloy suitable for protection of steel in submerged marine environment. They shall not have any mercury content. The potential of the sacrificial alloy material shall be (-) 1.08V or more negative referred to a silver/silver chloride reference electrode. *For material selection purpose*, the Electro-chemical efficiency of anode material shall be minimum 2500 AH/Kg after four (4) days of operation as per DNV RP B 401.

### **4.0 Testing and Inspection**

#### **4.1 Anode Composition analysis**

Anode composition analysis shall be undertaken by methods agreed upon in advance. Two samples from each melt shall be taken for chemical analysis. The samples shall be taken in the beginning and at the end of casting from the pouring

|              |                    |          |        |            |
|--------------|--------------------|----------|--------|------------|
| Format No    | Ref. Proc. No      | Issue No | Rev No | Rev. Date  |
| ODS/SOF/004B | ODS/SOP/008 to 015 | 01       | 01     | 15/10/2003 |



|   |  |   |                          |
|---|--|---|--------------------------|
|  | <b>OFFSHORE<br/>DESIGN<br/>SECTION</b> | <b>FUNCTIONAL<br/>SPECIFICATION FOR<br/>CATHODIC PROTECTION<br/>SYSTEM FOR SUBMARINE<br/>PIPELINE</b> | <b>SPEC. No.</b> FS 4002 |
|   |  |   | <b>Rev. No.</b> 9        |
|   |  |   | <b>Discipline</b> Elect  |
|   |  |   | Page: 7 of 13            |

string. Checking of closed circuit potential and practical mass consumption shall be done for each 15 ton produced anodes. The test samples may be separately casted or cut directly from an anode. Ampere-hour capacity test shall be carried out be weight loss method only.

- 4.1.2 After casting, the inspection of the anodes shall be done to ensure that:
- 4.1.3 AH capacity of anodes shall not be less than the figures considered for design i.e. no negative tolerance shall be permitted.
- 4.1.4 Closed circuit potential shall be within (+) 10 mV and (-) 50mV of the guaranteed value. For example, for design value of (-) 1.08 volts, anodes having closed circuit potential less negative than (-) 1.07 Volts shall be rejected.
- 4.1.5 The anodes shall have minimum net weight (Gross weight minus core weight) within a tolerance of + 2.0% to – 1.0%. However, overall negative tolerance shall be 0% to ensure that is no short fall in total alloy weight.
- 4.1.6 Dimensions shall be within tolerance limits indicated in the approved drawings. No negative tolerance shall be allowed in standoff dimensions.
- 4.1.7 At least one anode per delivery or at least 0.5 percent of the anodes shall be subjected to destructive testing to check that the casting is to an acceptable standard, each anode shall be cut at 3 of the most relevant locations. The cut surface shall generally be free from visible pores and slag/dross inclusions. The lack of bond or void between anode core and anode material shall not exceed 5%.  
As an alternate to a destructive testing, a non-destructive testing by radiography may be used to check for lack of bond or slag/dross inclusions if so permitted by the Company or its authorized representative.
- 4.1.8 Anode to steel insert shall be checked for electrical continuity. The resistance between the connector and the body of the anode shall not exceed 0.005 ohm.
- 4.1.9 The electrical continuity and resistance tests shall be performed for flexible lines as per API 17J.
- 4.1.10 The anodes shall be free from mechanical defects like cracks, shrinkages, excessive flash, surface projections, laminations, cold laps, surface slag, etc. as consistent with good casting practice. Criteria for accepting these shall be as per NACE RP 0492-92.

| Format No    | Ref. Proc. No      | Issue No | Rev No | Rev. Date  |
|--------------|--------------------|----------|--------|------------|
| ODS/SOF/004B | ODS/SOP/008 to 015 | 01       | 01     | 15/10/2003 |



OFFSHORE  
DESIGN  
SECTION

FUNCTIONAL  
SPECIFICATION FOR  
CATHODIC PROTECTION  
SYSTEM FOR SUBMARINE  
PIPELINE

|               |         |
|---------------|---------|
| SPEC. No.     | FS 4002 |
| Rev. No.      | 9       |
| Discipline    | Elect   |
| Page: 8 of 13 |         |

All the above Inspection / tests shall be witnessed by Company or its authorized representative.

All anodes shall be delivered with material certificate from the Vendor stating batch identification number and chemical analysis.

4.1.11 All work, materials, and equipments shall be subjected to inspection by Company at all reasonable times. However inspection by the Company shall not relieve the Vendor of his responsibility under terms of contract.

### 5.0 Anode Dimensions & Physical Characteristics

Anodes shall be half-shell bracelet type with steel inserts, which support the anode material and provide electrical continuity to the pipe by bonding leads. The steel core / insert of the anode and stub pipes or brackets provided for mounting the anode on the structure shall conform to ASTM-A36 or equivalent (for structural shapes) and API-5L Gr. B Seamless (for pipes) or equivalent.

For the I/J Tubes of flexible lines, anodes shall be flush type designed so as to fit the outside of the J tube.

### 6.0 Anode Installation

Anode attachment / detailed installation procedures shall be submitted to Company for approval prior to taking up the job. All welding shall be in accordance with qualified procedures indicated in the relevant specification in the Bid document. All bracelets shall be visually inspected to assure all faces to be exposed have been properly cleaned and free of paint or other contamination.

All weld connections are to be inspected prior to coal tar flood coating. This inspection shall ensure a firmly attached bond and electrical continuity.

For flexible pipelines, anodes shall be installed at/near to the end fittings.

#### 6.1 Anode Installation for Rigid Pipelines In case of Reel Lay Method

Anodes shall be installed on the pipelines during laying operations. Anode pads shall be pre-welded onto pipe joints mid-way from the joint end prior to pipe coating operations and places 180<sup>0</sup> diametrically opposite. The anode pad pipe joints shall be welded up into pipe stalks in accordance with ONGC approved stalk assembly drawings. The pad locations on the pipelines shall be identified by taping wide red

| Format No    | Ref. Proc. No      | Issue No | Rev No | Rev. Date  |
|--------------|--------------------|----------|--------|------------|
| ODS/SOF/004B | ODS/SOP/008 to 015 | 01       | 01     | 15/10/2003 |

|   |  |   |                          |
|---|--|---|--------------------------|
|  | <b>OFFSHORE<br/>DESIGN<br/>SECTION</b> | <b>FUNCTIONAL<br/>SPECIFICATION FOR<br/>CATHODIC PROTECTION<br/>SYSTEM FOR SUBMARINE<br/>PIPELINE</b> | <b>SPEC. No.</b> FS 4002 |
|   |  |   | <b>Rev. No.</b> 9        |
|   |  |   | <b>Discipline</b> Elect  |
|   |  |   | Page: 9 of 13            |

bands around the pipe at appropriate places. The half shell bracelet anodes shall be bolted onto the pipe at the anode pad locations. The electrical connection from anode to pipe shall be made by welding anode straps of suitable size to the anode pads. Anode attachment / installation procedure shall be submitted to Company for approval prior to taking up the job.

## 7.0 Service after installation

**7.1** The contractor shall carry out post installation CP potential survey for all pipelines and risers after 30 days (min) of the laying to ensure that the system has polarized and attained the required level of protection potential. On locations where the response is inadequate and measurements indicate that cathodic protection has not been attained, Contractor shall take necessary corrective measures including installation of additional anodes, if necessary. During detailed engineering, the contractor shall develop and submit procedure for carrying out CP potential survey, for Company's approval. However, the survey procedure shall comply with the requirements of DNV standard RP B-403 The basis of redesign / redistribution and all relevant back-up documents, as required by the Company, shall be made available by the contractor for review and approval.

**7.2** The potential measurement for each pipeline shall be carried out by towed fish method (Trailing Wire Survey) along the entire length of the pipeline in accordance with applicable international standards. Pipe to electrolyte potential at an interval of 1.0 to 1.5 m along the entire length of the pipelines shall be measured and recorded using a microprocessor based system. Positioning equipment shall ensure that the reference cell mounted on the carrier is positioned at a distance less than  $\pm 20$  m from the "As laid Position" of the pipelines.

Cell to Cell method for potential survey may be used after obtaining necessary approval of the Company either in the event of wire break during course of survey by the towed fish method for such long lines where resurvey on reaching over to the other end to run back the survey would be difficult.

Detailed survey procedures including details of positioning / navigation equipment, instruments used for measurement and recording as well as the procedure for calibration of instruments shall be submitted by the Contractor for approval by the Company.

| Format No    | Ref. Proc. No      | Issue No | Rev No | Rev. Date  |
|--------------|--------------------|----------|--------|------------|
| ODS/SOF/004B | ODS/SOP/008 to 015 | 01       | 01     | 15/10/2003 |

|   |  |   |  |                  |                |                 |   |                   |              |                |  |
|---|--|---|--|------------------|----------------|-----------------|---|-------------------|--------------|----------------|--|
|    | <b>OFFSHORE<br/>DESIGN<br/>SECTION</b> | <b>FUNCTIONAL<br/>SPECIFICATION FOR<br/>CATHODIC PROTECTION<br/>SYSTEM FOR SUBMARINE<br/>PIPELINE</b> | <table border="1"> <tr> <td><b>SPEC. No.</b></td> <td><b>FS 4002</b></td> </tr> <tr> <td><b>Rev. No.</b></td> <td>9</td> </tr> <tr> <td><b>Discipline</b></td> <td><b>Elect</b></td> </tr> <tr> <td colspan="2">Page: 10 of 13</td> </tr> </table> | <b>SPEC. No.</b> | <b>FS 4002</b> | <b>Rev. No.</b> | 9 | <b>Discipline</b> | <b>Elect</b> | Page: 10 of 13 |  |
| <b>SPEC. No.</b>  | <b>FS 4002</b>                         |   |  |                  |                |                 |   |                   |              |                |  |
| <b>Rev. No.</b>   | 9                                      |   |  |                  |                |                 |   |                   |              |                |  |
| <b>Discipline</b>   | <b>Elect</b>                           |   |  |                  |                |                 |   |                   |              |                |  |
| Page: 10 of 13  |  |   |  |                  |                |                 |   |                   |              |                |  |
| <p>Risers at platform connected pipelines shall also be surveyed for potential using dunking cell and drop cell method. The survey of the risers shall be done to check the potential level at regular depths along the riser. The clamps which will be installed for risers will be cathodically protected by the existing anodes of the jacket; CP readings are to be recorded on the riser clamps after installation. Jacket anodes in case of fouling will be relocated and the CP readings are to be taken on the jacket braces at relocation points and submitted to ONGC for information.</p> <p>The final survey report data shall be presented on the alignment sheets for the pipeline with all corrected measurements shown as continuous line plots of pipe / sea potential correlating with the positional / navigational data and time. Extended scale plots shall be provided for areas of particular interest such as grout sleeve areas, crossing of other pipelines, areas with stress concentration, areas expected to have stray current interference etc.</p> <p>In areas where measurements indicate that Cathodic Protection has not been attained whether due to coating damage or damage of cable or inactive anodes, necessary corrective action shall be in the Contractor's scope including but not limited to mounting of additional sacrificial anodes. Detailed procedure for the corrective action shall be furnished by the Contractor for the approval of the Company.</p> <p><b>7.3</b> The Contractor shall carry out potential survey for all the flexible pipelines and I / J tubes. Prior to taking up the survey, relevant procedure along with all the related documents will be submitted to company for approval. In a situation where potential measurements indicate that cathodic protection has not been attained, taking necessary corrective action shall be in the contractor's scope of work including but not limited to mounting of additional anodes.</p> <p>Detailed procedure for the corrective action shall be furnished by the contractor for company's approval.</p> <p><b>8 Electrical Continuity And Resistance Tests For Pipelines.</b></p> <p>The electrical continuity and resistance tests shall be performed after completion of hydrostatic test. The electrical continuity test shall be performed between segment ends. Electrical resistance tests shall be performed between the segment end fittings and the carcass. The measured values for both the tests shall be recorded. The acceptance criteria shall be as follows:</p> |  |   |  |                  |                |                 |   |                   |              |                |  |

| Format No    | Ref. Proc. No      | Issue No | Rev No | Rev. Date  |
|--------------|--------------------|----------|--------|------------|
| ODS/SOF/004B | ODS/SOP/008 to 015 | 01       | 01     | 15/10/2003 |



OFFSHORE  
DESIGN  
SECTION

FUNCTIONAL  
SPECIFICATION FOR  
CATHODIC PROTECTION  
SYSTEM FOR SUBMARINE  
PIPELINE

|                |         |
|----------------|---------|
| SPEC. No.      | FS 4002 |
| Rev. No.       | 9       |
| Discipline     | Elect   |
| Page: 11 of 13 |         |

Electrical resistance between internal carcass and the end fittings: 1 Mega ohm (min)

Electrical resistance between segment end fittings: 10 ohm/km (max.)

#### 9.0 Warranty:

Vendor shall have final and total responsibility for the design and performance of all equipments supplied and guarantees the equipment/anode for their design life. Vendor shall warrant the equipments furnished by him and their performance in accordance with this specification and 'General Specification- Definition. (Spec No. 1050)

#### 10 Vendor Pre - qualification:

Vendor Pre-qualification will be as per the requirements stated elsewhere in the bid document

#### 11. Vendor Data Requirements

Vendor shall furnish the following information relative to the anodes

- 10.1 Dimensional drawings of sacrificial anodes and supporting parts or accessories along with separate as well as assembled drawings for their supporting parts and other accessories
- 10.2 Net, gross, and buoyant weight of anodes.
- 10.3 Minimum closed-circuit potential in volts.
- 10.4 Recommended means of anode support.
- 10.5 Anode alloying compositions (% age by weight and volume)
- 10.6 Testing method of anodes and details of the test procedure. The test shall establish the guaranteed minimum electro-chemical value of the anode material and its potential w.r.t. Ag/AgCl reference electrode under site conditions.
- 10.7 Calculation of anode quantity and weight based on current and weight basis for the design life

#### 12.0 PACKING AND TRANSPORTATION:

The offered equipment along with their accessories shall be shipped to anode installation site, packed in wooden crates. They shall be wrapped with polythene

| Format No    | Ref. Proc. No      | Issue No | Rev No | Rev. Date  |
|--------------|--------------------|----------|--------|------------|
| ODS/SOF/004B | ODS/SOP/008 to 015 | 01       | 01     | 15/10/2003 |



OFFSHORE  
DESIGN  
SECTION

FUNCTIONAL  
SPECIFICATION FOR  
CATHODIC PROTECTION  
SYSTEM FOR SUBMARINE  
PIPELINE

|                |         |
|----------------|---------|
| SPEC. No.      | FS 4002 |
| Rev. No.       | 9       |
| Discipline     | Elect   |
| Page: 12 of 13 |         |

sheets, before being placed in the crates to prevent damage to finish. Crates shall have skid bottom for handling.

#### DATA SHEET

1. Anode Material : GALVALUM – III or equivalent  
Mercury free Al-Zn-In alloy
2. Design Life : As mentioned elsewhere in bid  
documents
3. Sea Water Temperature : --
4. Resistivity
- Sea Water : 20 Ohm cm
  - Sea Mud : 40 Ohm cm
5. Anode Details
- a) Anode type/configuration : \*

| Format No    | Ref. Proc. No      | Issue No | Rev No | Rev. Date  |
|--------------|--------------------|----------|--------|------------|
| ODS/SOF/004B | ODS/SOP/008 to 015 | 01       | 01     | 15/10/2003 |

|   |  |   |                          |
|---|--|---|--------------------------|
|    | <b>OFFSHORE<br/>DESIGN<br/>SECTION</b> | <b>FUNCTIONAL<br/>SPECIFICATION FOR<br/>CATHODIC PROTECTION<br/>SYSTEM FOR SUBMARINE<br/>PIPELINE</b> | <b>SPEC. No.</b> FS 4002 |
|   |  |   | <b>Rev. No.</b> 9        |
|   |  |   | <b>Discipline</b> Elect  |
|   |  |   | Page: 13 of 13           |
| <p>b) Anode dimensions : *</p> <p>c) Anode driving potential : *</p> <p>d) Electro-chemical efficiency of anode material : *</p> <p>e) Anode utilization factor : *</p> <p>f) Anode output : *</p> <p>g) Anode potential : *</p> <p>h) Anode alloy composition (% of impurity elements) : *</p> <ul style="list-style-type: none"> <li>• Type : *</li> <li>• Material/Grade : *</li> <li>• Dimensions : *</li> <li>• Weight : *</li> </ul> <p>5. Minimum Protective Potential : *</p> <p>6. Details of Surface area to be Protected : *</p> <p>NOTE: -Vendor shall furnish data marked (*) along with bid<br/>-Splashed zone portion, in spite of protective coating, shall be treated as a bare for design of CP system.</p> |  |   |                          |

| Format No    | Ref. Proc. No      | Issue No | Rev No | Rev. Date  |
|--------------|--------------------|----------|--------|------------|
| ODS/SOF/004B | ODS/SOP/008 to 015 | 01       | 01     | 15/10/2003 |



**OFFSHORE  
ENGINEERING  
SERVICES**

**General FS**  
**“Part Replacement Pipeline  
Project”**

**Discipline**

**Quality  
Assurance**

**Revision No.**

**Page: 1 OF 1**

| S No | Document No. | Functional Specification                           | Revision |
|------|--------------|--|----------|
| 1    | 1050         | General Specification For Definition               | 0        |
| 2    | 1060         | General Specification For Vendor Data Requirements | 0        |
| 3    | 2009F        | Specification for Welding & NDT                    | 8        |

FORMAT No.

Ref. PROCEDURE No.

ISSUE No.

REV. No.

REV. DATE:

03

00

26.02.2018





OFFSHORE DESIGN  
SECTION  
MUMBAI REGION

GENERAL SPECIFICATION  
FOR DEFINITION

VOL. NO. III  
REV. NO. 0  
SPEC. NO. 1050  
SHEET NO 1 OF 7

# GENERAL SPECIFICATION FOR DEFINITION

OIL AND NATURAL GAS CORPORATION LTD.  
INDIA

Note: Reproduced from Rev. 0 issued earlier.

| BY     | APPD | REMARKS        | NO. OF PAGES | DATE       | REV. |
|--------|------|----------------|--------------|------------|------|
| J.S.M. |      | ISSUED FOR BID | 7            | 13.01.2005 | 0    |
| J.S.M. | -    | ISSUED FOR BID | 7            | 20.11.2001 | 0    |

| FORMAT No.   | Ref. PROCEDURE No. | ISSUE No. | REV. No. | REV. DATE:  |
|--------------|--------------------|-----------|----------|-------------|
| ODS/SOF/004A | ODS/SOP/008 TO 015 | 01        | 01       | 15/210/2003 |



**OFFSHORE DESIGN  
SECTION  
MUMBAI REGION**

**GENERAL SPECIFICATION  
FOR DEFINITION**

VOL. NO. III  
REV. NO. 0  
SPEC. NO. 1050  
SHEET NO 2 OF 7

## **CONTENTS**

- 1.0 SCOPE**
- 2.0 CODES AND STANDARDS**
- 3.0 LAYOUT AND OPERABILITY**
- 4.0 MANUFACTURERS AND VENDORS**
- 5.0 WARRANTIES**
- 6.0 MATERIALS OF CONSTRUCTION AND METALLURGY**
- 7.0 SAFETY PROVISIONS**

| FORMAT No.   | Ref. PROCEDURE No. | ISSUE No. | REV. No. | REV. DATE:  |
|--------------|--------------------|-----------|----------|-------------|
| ODS/SOF/004A | ODS/SOP/008 TO 015 | 01        | 01       | 15/210/2003 |



**OFFSHORE DESIGN  
SECTION  
MUMBAI REGION**

**GENERAL SPECIFICATION  
FOR DEFINITION**

|                 |
|-----------------|
| VOL. NO. III    |
| REV. NO. 0      |
| SPEC. NO. 1050  |
| SHEET NO 3 OF 7 |

## **1.0 SCOPE**

Specifications referred to as “General” for a specific category indicate a minimum standard of quality for materials, fabrication and/or erection of the proposed equipment. Responsibility for the proper interpretation of these specifications shall rest with appointed representatives of the Contractor and the Company. It will be Contractor’s responsibility to obtain clarification from Company’s representative, which in all cases shall be final and binding.

Individual specifications and/or drawings, when furnished, are to be used with the general specifications. If conflict exists, the individual specifications and/or drawings shall govern.

All equipment and materials supplied or installed under these specifications shall be installed in accordance with sound engineering principles and good fabrication and construction practice. No omission from these specifications shall relieve the Contractor from this responsibility.

## **2.0 CODES AND STANDARDS**

All equipment and materials fabricated and installed under these specifications shall conform to the latest editions of the applicable codes and standards cited in the bid documents. No omission in the project instructions shall be construed as relieving the Contractor of his responsibility to ascertain these requirements, to perform work and furnish material in accordance with the codes specified.

## **3.0 LAYOUT AND OPERABILITY**

The facility shall be laid out and constructed for convenience and safety of operation and maintenance. Similar equipment shall be grouped together as much

|                            |  |                 |                |                           |
|----------------------------|--|-----------------|----------------|---------------------------|
| FORMAT No.<br>ODS/SOF/004A | Ref. PROCEDURE No.<br>ODS/SOP/008 TO 015 | ISSUE No.<br>01 | REV. No.<br>01 | REV. DATE:<br>15/210/2003 |
|----------------------------|--|-----------------|----------------|---------------------------|



**OFFSHORE DESIGN  
SECTION  
MUMBAI REGION**

**GENERAL SPECIFICATION  
FOR DEFINITION**

VOL. NO. III

REV. NO. 0

SPEC. NO. 1050

SHEET NO 4 OF 7

as possible so as to best conform with good engineering practice and fulfil accepted standards of process simplicity, safety and economy. All equipment shall be oriented to permit servicing in such a way as to require a minimum of dismantling. For offshore platform facilities, conservation of space shall also be taken into account.

Contractor shall provide adequate design measures to handle all predictable occurrences resulting from weather, process upsets or operational failures, or interruption of utilities. All such features shall be provided unless brought to Company's attention and a specific agreement is reached to forgo such measures.

| FORMAT No.   | Ref. PROCEDURE No. | ISSUE No. | REV. No. | REV. DATE:  |
|--------------|--------------------|-----------|----------|-------------|
| ODS/SOF/004A | ODS/SOP/008 TO 015 | 01        | 01       | 15/210/2003 |



**OFFSHORE DESIGN  
SECTION  
MUMBAI REGION**

**GENERAL SPECIFICATION  
FOR DEFINITION**

|                 |
|-----------------|
| VOL. NO. III    |
| REV. NO. 0      |
| SPEC. NO. 1050  |
| SHEET NO 5 OF 7 |

**4.0 MANUFACTURERS AND VENDORS**

Evaluation and selection of Vendors shall be done from the viewpoint of both supply and maintenance, and all suppliers must be willing and capable of providing service for their goods.

No provision of these specifications shall imply rejection of a Vendor’s standard designed and purchased equipment, provided this equipment is equivalent to or better than that specified and approved by Company.

All equipment shall be of proven design. Prototypes new designs, or extensive modifications of standard designs are unacceptable.

Unless otherwise specified, the naming of a specific manufacturer’s product indicates, in general, a standard of quality only. An “equivalent” specification may be substituted according to the practice of the industry; however, such substitutions shall be approved in writing by Company.

**5.0 WARRANTIES**

**5.1 Contractor shall -**

Warrant all material and equipment to be free from defects in design, material and workmanship.

Warrant that all equipment will satisfy the requirements of the intended use and be suitable for the application.

|                            |  |                 |                |                           |
|----------------------------|--|-----------------|----------------|---------------------------|
| FORMAT No.<br>ODS/SOF/004A | Ref. PROCEDURE No.<br>ODS/SOP/008 TO 015 | ISSUE No.<br>01 | REV. No.<br>01 | REV. DATE:<br>15/210/2003 |
|----------------------------|--|-----------------|----------------|---------------------------|



**OFFSHORE DESIGN  
SECTION  
MUMBAI REGION**

**GENERAL SPECIFICATION  
FOR DEFINITION**

|                 |
|-----------------|
| VOL. NO. III    |
| REV. NO. 0      |
| SPEC. NO. 1050  |
| SHEET NO 6 OF 7 |

Agree to repair or replace any equipment under this warranty which proves to be defective within a period of 12 months after being placed in operation, but no exceeding 18 months from the date of shipment.

Assume responsibility for obtaining manufacturer's performance warranty for all equipment purchased.

- 5.2 Where materials of construction or the application of equipment recommended by Contractor do not conform with the manufacturer's recommendations, the Contractor shall assume the equivalent of the equipment manufacturer's warranty and in the event of malfunction or damage resulting from this misapplication, the Contractor will not be released from this warranty.

**6.0 MATERIALS OF CONSTRUCTION AND METALLURGY**

Unless other wise specified, all materials and equipment shall be new. All materials supplied under these specifications shall be adequate for the proposed service. Proper consideration shall be given to their function with regard to corrosion, chemical attack and other process hazards and precautions to avoid these hazards shall be taken. Such precautions shall include but not be limited to the following.

- 6.1 Selection – Adequate to meet process requirements, together with foreseeable contingencies.
- 6.2 Heat treatment – Suitable treatment of materials to minimize corrosion, prevent hydrogen embrittlement, and for strength considerations per applicable codes.
- 6.3 Protective coating – Suitable as required to preserve the utility, efficiency, and appearance of the equipment under offshore operating conditions where applicable.

|              |                    |           |          |             |
|--------------|--------------------|-----------|----------|-------------|
| FORMAT No.   | Ref. PROCEDURE No. | ISSUE No. | REV. No. | REV. DATE:  |
| ODS/SOP/004A | ODS/SOP/008 TO 015 | 01        | 01       | 15/210/2003 |



**OFFSHORE DESIGN  
SECTION  
MUMBAI REGION**

**GENERAL SPECIFICATION  
FOR DEFINITION**

|                 |
|-----------------|
| VOL. NO. III    |
| REV. NO. 0      |
| SPEC. NO. 1050  |
| SHEET NO 7 OF 7 |

6.4 Corrosion allowance and safety factor – Within good engineering practice with a minimum as stated in the relevant General Specifications.

Particular attention shall be given to the metallurgy and arrangement of equipment in contact with fluid and which is likely to be exposed internally and externally to corrosive media. All phases of the process and mechanical design of the facility must be thoroughly checked to assure that unsatisfactory conditions such as freezing, plugging and /or undesirable chemical reactions will not occur.

**7.0 SAFETY PROVISIONS**

It is the intent of the Company that operational hazards be reduced to a mini-mum. Contractor shall use sound engineering judgment to complete an installation that will perform the required process function without compromising this aim. The platform shall be designed in accordance with API RP 14C. Recommended Practice for Analysis, Design, Installation and Testing of Basic Surface Safety Systems on Offshore Protection Platforms, latest edition.

-----

|              |                    |           |          |             |
|--------------|--------------------|-----------|----------|-------------|
| FORMAT No.   | Ref. PROCEDURE No. | ISSUE No. | REV. No. | REV. DATE:  |
| ODS/SOF/004A | ODS/SOP/008 TO 015 | 01        | 01       | 15/210/2003 |



**making  
tomorrow  
brighter**

**OFFSHORE DESIGN  
SECTION  
MUMBAI REGION**

**GENERAL SPECIFICATION  
FOR VENDOR DATA  
REQUIREMENT**

VOL. NO.III

REV. NO. 0

Spec 1060

SHEET 1 OF 12

**GENERAL SPECIFICATION  
FOR  
VENDOR DATA REQUIREMENTS**

**OIL AND NATURAL GAS CORPORATION LTD.  
INDIA**

**NOTE: Reproduced from earlier issued revision**

|          |             |                |           |           |         |
|----------|-------------|----------------|-----------|-----------|---------|
|          |             |                |           |           |         |
| JSM      | -           | ISSUED FOR BID | 12        | 14.01.200 | 0       |
| -        | -           | ISSUED FOR BID | -         | -         | 0       |
| PREPD BY | APPROVED BY | REMARK         | TOTALPAGE | DATE      | REV No. |

|                            |  |                 |                |                          |
|----------------------------|--|-----------------|----------------|--------------------------|
| FORMAT No.<br>ODS/SOF/004A | Ref. PROCEDURE No.<br>ODS/SOP/008 TO 015 | ISSUE No.<br>01 | REV. No.<br>01 | REV. DATE:<br>15/10/2003 |
|----------------------------|--|-----------------|----------------|--------------------------|





OFFSHORE DESIGN  
SECTION  
MUMBAI REGION

GENERAL SPECIFICATION  
FOR VENDOR DATA  
REQUIREMENT

VOL. NO.III  
REV. NO. 0  
Spec 1060  
SHEET 2 OF 12

## CONTENTS

PROFORMA

SPECIAL NOTES TO VENDORS

**Note:** Contractor to complete the attached Vendor Data Requirements form as required. Contractor shall include the requirements for approval before furnishing this to Vendors. Minimum 8 No. sets of dossier shall be included for the Purchaser/Consultant.

Vendor shall furnish the following data in the number of copies indicated with proposal/after purchaser order. Number of weeks indicated are following receipt of Purchase Order.

| S. No. | Data/ Drawings | No. of Prints With proposal | Certified information after Purchase Order |                        |                     |                |                        |                     |
|--------|----------------|-----------------------------|--|------------------------|---------------------|----------------|------------------------|---------------------|
|        |                |                             | For Approval                               |                        |                     | For Dossier    |                        |                     |
|        |                |                             | Repro-ducibles                             | Prints (No. of) Copies | Date needed (Weeks) | Repro-ducibles | Prints (No. of) Copies | Date needed (Weeks) |
| 1      | 2              | 3                           | 4  | 5                      | 6                   | 7              | 8                      | 9                   |

1. Manufacturing Schedule
2. Monthly Progress Report
3. Leaflets/ Catalogues (Main Equip. & Aux. Equip.)
4. Catalogues for Components in Vendor's scope

|                            |  |                 |                |                          |
|----------------------------|--|-----------------|----------------|--------------------------|
| FORMAT No.<br>ODS/SOF/004A | Ref. PROCEDURE No.<br>ODS/SOP/008 TO 015 | ISSUE No.<br>01 | REV. No.<br>01 | REV. DATE:<br>15/10/2003 |
|----------------------------|--|-----------------|----------------|--------------------------|



**OFFSHORE DESIGN  
SECTION  
MUMBAI REGION**

**GENERAL SPECIFICATION  
FOR VENDOR DATA  
REQUIREMENT**

VOL. NO.III  
REV. NO. 0  
Spec 1060  
SHEET 3 OF 12

- 5. Deviation list (s)
- 6. Completed Data Sheets (Main/ Aux. Equip.)
- 7. Auxiliary Equipment Sheet (s)

| S. No. | Data/ Drawings | No. of Prints With proposal | Certified information after Purchase Order |                       |                     |                |                       |                     |
|--------|----------------|-----------------------------|--|-----------------------|---------------------|----------------|-----------------------|---------------------|
|        |                |                             | For Approval                               |                       |                     | For Dossier    |                       |                     |
|        |                |                             | Repro-ducibles                             | Prints (No.of) Copies | Date Needed (Weeks) | Repro-ducibles | Prints (No.of) Copies | Date needed (Weeks) |
| 1      | 2              | 3                           | 4  | 5                     | 6                   | 7              | 8                     | 9                   |

- 7A Data & Drgs. for Couplings, Gear Boxes, Heat Exchangers, Lube Oil Tanks ect.
- 8. Motor Data Sheet (s) (Main & Aux.)
- 9. Performance Curves
- 10. Motor Characteristic Curves  
  
Utility Requirements (Characteristics & Quantity)

|                            |  |                 |                |                          |
|----------------------------|--|-----------------|----------------|--------------------------|
| FORMAT No.<br>ODS/SOF/004A | Ref. PROCEDURE No.<br>ODS/SOP/008 TO 015 | ISSUE No.<br>01 | REV. No.<br>01 | REV. DATE:<br>15/10/2003 |
|----------------------------|--|-----------------|----------------|--------------------------|



**making  
tomorrow  
brighter**

**OFFSHORE DESIGN  
SECTION  
MUMBAI REGION**

**GENERAL SPECIFICATION  
FOR VENDOR DATA  
REQUIREMENT**

VOL. NO.III

REV. NO. 0

Spec 1060

SHEET 4 OF 12

- 12. Lubricants  
List with  
Specifications
- 13. Main P& ID'S  
& Bill of  
Materials
- 14. Auxiliary  
System (s)  
P&ID's & Bill  
of Materials,  
(such as lube/  
seal oil, cool-  
ing water, Inst.  
air/gas diag.,  
fuel system.  
unloading comp.,  
seal, flushing/  
quenching, wash  
water, flushing/  
quenching, wash  
water. Fire system  
etc.).
- 15. G. A. Drawing  
including auxi-  
liary all piping  
including  
valving & Other  
accessories, and  
purchasers  
piping connect-  
ion at battery  
limits (Separate  
G. A. drgs. for  
Auxiliaries &  
aux. systems  
also to be give).

|                            |  |                 |                |                          |
|----------------------------|--|-----------------|----------------|--------------------------|
| FORMAT No.<br>ODS/SOF/004A | Ref. PROCEDURE No.<br>ODS/SOP/008 TO 015 | ISSUE No.<br>01 | REV. No.<br>01 | REV. DATE:<br>15/10/2003 |
|----------------------------|--|-----------------|----------------|--------------------------|



**making  
tomorrow  
brighter**

**OFFSHORE DESIGN  
SECTION  
MUMBAI REGION**

**GENERAL SPECIFICATION  
FOR VENDOR DATA  
REQUIREMENT**

VOL. NO.III

REV. NO. 0

Spec 1060

SHEET 5 OF 12

16. Loading Data  
(Main Equipment  
& Auxiliaries).
17. Design details  
of Structural  
base.
18. Parts list with  
Cross Sectional  
Drawings  
giving critical  
clearances for  
main & aux. equipments
19. Component out-  
Line Drawings.
20. Component  
cross-sectional  
Drawings includ-  
ing mech. seals.
21. Assembly draw-  
ings including  
Auxiliary Eqpt.  
Assembly  
Drawings.
22. Sub-vendor drg.  
with complete  
Bill of Materials.
23. Vessel Design  
Calculations.
24. Vessel Fabri-  
cation drawings.

|                            |  |                 |                |                          |
|----------------------------|--|-----------------|----------------|--------------------------|
| FORMAT No.<br>ODS/SOF/004A | Ref. PROCEDURE No.<br>ODS/SOP/008 TO 015 | ISSUE No.<br>01 | REV. No.<br>01 | REV. DATE:<br>15/10/2003 |
|----------------------------|--|-----------------|----------------|--------------------------|



**making  
tomorrow  
brighter**

**OFFSHORE DESIGN  
SECTION  
MUMBAI REGION**

**GENERAL SPECIFICATION  
FOR VENDOR DATA  
REQUIREMENT**

VOL. NO.III

REV. NO. 0

Spec 1060

SHEET 6 OF 12

25. Allowable forces and moments on nozzles.

26. Piping Bill of Material.

27. Purchaser's piping connections (with flange details).

28. Complete Instrument and Annunciator List

29. Instrument Data Sheet with sizing Calculations.

30. Instrument Dimensional Drgs. with Mounting Details.

Instrument Tubing, Wiring & Junction Box Schedule.  
Control Schematic including:  
Alarms, Trips & Interlocks Logic Diagrams with Description:  
Alarms, Trips & Interlocks Wiring Diagram.  
For all panels).

|                            |  |                 |                |                          |
|----------------------------|--|-----------------|----------------|--------------------------|
| FORMAT No.<br>ODS/SOF/004A | Ref. PROCEDURE No.<br>ODS/SOP/008 TO 015 | ISSUE No.<br>01 | REV. No.<br>01 | REV. DATE:<br>15/10/2003 |
|----------------------------|--|-----------------|----------------|--------------------------|



**making  
tomorrow  
brighter**

**OFFSHORE DESIGN  
SECTION  
MUMBAI REGION**

**GENERAL SPECIFICATION  
FOR VENDOR DATA  
REQUIREMENT**

VOL. NO.III

REV. NO. 0

Spec 1060

SHEET 7 OF 12

- 33. Impulse piping hook up with Bill of Materials.
- 34. Local Panel G. A. Drgs. with Fixing Details.
- 35. Local Panel/ Remote Panel Wiring Diagram identifying external connections.
- 36. Remote Control Panel G. A. Drawing with Fixing Details.
- 37. Dimensional Semigraphic Flow Plans.
- 38. Terminal Details of Interface with Telemetry Equipment.  
  
Electrical (General Arrangement & Layout Drawings.
- 40. Electrical Load List
- 41. Electrical Scheme Drawing/Writing &

|                            |  |                 |                |                          |
|----------------------------|--|-----------------|----------------|--------------------------|
| FORMAT No.<br>ODS/SOF/004A | Ref. PROCEDURE No.<br>ODS/SOP/008 TO 015 | ISSUE No.<br>01 | REV. No.<br>01 | REV. DATE:<br>15/10/2003 |
|----------------------------|--|-----------------|----------------|--------------------------|



**making  
tomorrow  
brighter**

**OFFSHORE DESIGN  
SECTION  
MUMBAI REGION**

**GENERAL SPECIFICATION  
FOR VENDOR DATA  
REQUIREMENT**

VOL. NO.III

REV. NO. 0

Spec 1060

SHEET 8 OF 12

Interconnect-  
ion Diagram.

42. Terminal Box  
Dimensional  
Drawings.

42A. Write up on  
automatic  
control of  
Turbo-Gener-  
ator and the  
same when  
units are run  
in parallel.

43. Test Certifi-  
cate (Instruments).

44. Mechanical  
Run Layout  
& Procedure  
of Main &  
Aux. Equip-  
ments.

Performance  
Test Layout  
& Procedure  
(Main & Aux.  
Equip. Systems).

45A. String test  
Layout & Proce-  
dure (Gas Tur-  
bine, Gear box  
Generator &  
Motor gear  
box main pump).

46 Layout & Procedure

|                            |  |                 |                |                          |
|----------------------------|--|-----------------|----------------|--------------------------|
| FORMAT No.<br>ODS/SOF/004A | Ref. PROCEDURE No.<br>ODS/SOP/008 TO 015 | ISSUE No.<br>01 | REV. No.<br>01 | REV. DATE:<br>15/10/2003 |
|----------------------------|--|-----------------|----------------|--------------------------|



**making  
tomorrow  
brighter**

**OFFSHORE DESIGN  
SECTION  
MUMBAI REGION**

**GENERAL SPECIFICATION  
FOR VENDOR DATA  
REQUIREMENT**

VOL. NO.III

REV. NO. 0

Spec 1060

SHEET 9 OF 12

of any other  
test(s) specified  
by Company.  
Motor gear  
box main pump).

46A. Layout & Proce-  
dure of any other  
test(s) specified  
by Company  
Motor gear  
box main pump).

46B. Layout & Proce-  
dure of any other  
test(s) specified  
by Company).

47. Lateral and  
Torsional  
Analysis  
Report.

48. Mill Test  
Reports.

49. Record Showing  
Location  
of Heat Numbers.

50. Test Certificates/records  
for all non-  
destructive  
tests specified  
in spec. /data  
sheets such as  
radiography,  
ultrasonic etc.

51. Stress Relief  
Charts.

|                            |  |                 |                |                          |
|----------------------------|--|-----------------|----------------|--------------------------|
| FORMAT No.<br>ODS/SOF/004A | Ref. PROCEDURE No.<br>ODS/SOP/008 TO 015 | ISSUE No.<br>01 | REV. No.<br>01 | REV. DATE:<br>15/10/2003 |
|----------------------------|--|-----------------|----------------|--------------------------|





**making  
tomorrow  
brighter**

**OFFSHORE DESIGN  
SECTION  
MUMBAI REGION**

**GENERAL SPECIFICATION  
FOR VENDOR DATA  
REQUIREMENT**

VOL. NO.III

REV. NO. 0

Spec 1060

SHEET 10 OF 12

52. Welding  
Procedures.
- Inspection &  
Test Reports.  
(i.e. Hydrostatic  
test performance  
test etc. )
- Manufacturer's  
Test Certificates  
for suborder  
item's.
- Final Accept-  
ance Testing &  
performance  
Test Reports.
- Vendor quality  
assurance  
practices
- Standard &  
Special Tools  
List including  
tools required  
for overhaul/  
calibration.
- Installation  
Operating  
Instructions.
- Maintenance  
Instructions.
- Shop Repair  
Manual includ-  
ing Assembly

|                            |  |                 |                |                          |
|----------------------------|--|-----------------|----------------|--------------------------|
| FORMAT No.<br>ODS/SOF/004A | Ref. PROCEDURE No.<br>ODS/SOP/008 TO 015 | ISSUE No.<br>01 | REV. No.<br>01 | REV. DATE:<br>15/10/2003 |
|----------------------------|--|-----------------|----------------|--------------------------|



**making  
tomorrow  
brighter**

**OFFSHORE DESIGN  
SECTION  
MUMBAI REGION**

**GENERAL SPECIFICATION  
FOR VENDOR DATA  
REQUIREMENT**

VOL. NO.III

REV. NO. 0

Spec 1060

SHEET 11 OF 12

showing critical clearances.

\*61. Spare Parts List (for 2 years operations)

61A. List of spare parts for First overhaul.

\*62. Start-up and Commissioning Spares List.

63. Mechanical Catalogue containing all items except those marked with asterisk (\*)

\*64. Painting Procedure

\*65. Name Plate Rubbing.

\*66. List of Similar Installations.

67. G. A. drg. For fire & gas detection system of power generator unit.

|                            |  |                 |                |                          |
|----------------------------|--|-----------------|----------------|--------------------------|
| FORMAT No.<br>ODS/SOF/004A | Ref. PROCEDURE No.<br>ODS/SOP/008 TO 015 | ISSUE No.<br>01 | REV. No.<br>01 | REV. DATE:<br>15/10/2003 |
|----------------------------|--|-----------------|----------------|--------------------------|



OFFSHORE DESIGN  
SECTION  
MUMBAI REGION

GENERAL SPECIFICATION  
FOR VENDOR DATA  
REQUIREMENT

VOL. NO.III  
REV. NO. 0  
Spec 1060  
SHEET 12 OF 12

### SPECIAL NOTES TO VENDOR

1. The Vendor shall be held accountable for furnishing all data/drawings in proper form and quantity in accordance with these requirements. The Vendor shall also be accountable for the documentation required from his sub-vendor.
2. Each Vendor data item requested above must be identified by the Purchase Order number and equipment tag number located on the cover sheet or First page of said item and in the case of engineering drawings, on each and every drawing.
3. Any additional data/drawings required as a result of issuing supplements to a purchase order or during detailed engineering shall be furnished by Vendor and handled in the same manner as the original order.
4. All drawings and literatures shall be in the English language and the Metric Measurement System.
5. The reproducible drawings, 279 mm x 432 mm (11" x 17") size and full size are to be of such quality that Clear Legible prints can be made with Osolid type reproduction facilities.

-----

|              |                    |           |          |            |
|--------------|--------------------|-----------|----------|------------|
| FORMAT No.   | Ref. PROCEDURE No. | ISSUE No. | REV. No. | REV. DATE: |
| ODS/SOF/004A | ODS/SOP/008 TO 015 | 01        | 01       | 15/10/2003 |

|   |   |   |                      |                          |
|---|---|---|----------------------|--------------------------|
|  | <b>Offshore Design Section<br/>Engineering Services<br/>ISO – 9001:2008</b> | <b>FUNCTIONAL SPECIFICATION<br/>FOR Welding &amp; NDT</b> | <b>Spec. No.</b>     | <b>2009F</b>             |
|   |   |   | <b>Rev. No.</b>      | <b>8</b>                 |
|   |   |   | <b>Discipline</b>    | <b>Quality Assurance</b> |
|   |   |   | <b>Page: 1 OF 36</b> |                          |

**FUNCTIONAL SPECIFICATION**  
  
**FOR**  
  
***“Welding & NDT”***

| <b>Prepared / Revised By</b> | <b>Reviewed By</b> | <b>Approved By</b> | <b>Total No. of Pages</b> | <b>Date</b> | <b>Rev. No.</b> |
|------------------------------|--------------------|--------------------|---------------------------|-------------|-----------------|
|                              |                    |                    | 36                        | 28.04.2016  | 8               |
| Goutam Jana                  | M.R.Shete          | S.C. Jain          |                           |             |                 |

|                   |                           |                  |                 |                   |
|-------------------|---------------------------|------------------|-----------------|-------------------|
| <b>FORMAT No.</b> | <b>Ref. PROCEDURE No.</b> | <b>ISSUE No.</b> | <b>REV. No.</b> | <b>REV. DATE:</b> |
| ODS/SOF/004       | ODS/SOP/023               | 01               | 00              | 21.07.2010        |

|   |   |   |                      |                          |
|---|---|---|----------------------|--------------------------|
|  | <b>Offshore Design Section<br/>Engineering Services<br/>ISO – 9001:2008</b> | <b>FUNCTIONAL SPECIFICATION<br/>FOR Welding &amp; NDT</b> | <b>Spec. No.</b>     | <b>2009F</b>             |
|   |   |   | <b>Rev. No.</b>      | <b>8</b>                 |
|   |   |   | <b>Discipline</b>    | <b>Quality Assurance</b> |
|   |   |   | <b>Page: 2 OF 36</b> |                          |

## Revision Status Record

|                                  |                    |                    |                               |             |                 |
|----------------------------------|--------------------|--------------------|-------------------------------|-------------|-----------------|
| G.JANA                           | M.R.Shete          | S.C.JAIN           | 36                            | 28.04.2016  | 8               |
| MKV/DB                           | PNN                | CBS                | 36                            | 26.05.2011  | 7               |
| PDD/PNN                          | SKS                | JSS                | 24                            | 10.01.2005  | 6               |
| <b>Prepared /<br/>Revised By</b> | <b>Reviewed By</b> | <b>Approved By</b> | <b>Total No. of<br/>Pages</b> | <b>Date</b> | <b>Rev. No.</b> |

|             |                    |           |          |            |
|-------------|--------------------|-----------|----------|------------|
| FORMAT No.  | Ref. PROCEDURE No. | ISSUE No. | REV. No. | REV. DATE: |
| ODS/SOF/004 | ODS/SOP/023        | 01        | 00       | 21.07.2010 |



| Section | Content                                      | Page No. |
|---------|--|----------|
| 1.0     | Scope  | 4        |
| 1.1     | Regulatory Considerations                    | 4        |
| 1.2     | Abbreviations                                | 4        |
| 1.3     | Quality Assurance                            | 5        |
|         |  |          |
| PP2.0   | <b>PIPING &amp; PRESSURE VESSELS</b>         | 10       |
| PP2.1   | Codes & Standards                            | 10       |
| PP2.2   | Weld Procedure Qualification & Documentation | 11       |
| PP2.3   | Welder Qualification                         | 12       |
| PP2.4   | Production Welding                           | 12       |
| PP2.5   | NDT Techniques                               | 14       |
| PP2.6   | NDT Procedure                                | 15       |
| PP2.7   | Extent of NDT Coverage                       | 16       |
| PP2.8   | NDT Operator                                 | 17       |
| PP2.9   | Advanced UT Techniques                       | 17       |
| PP2.10  | NDT Acceptance Criteria                      | 18       |
| PP2.11  | Heat Treatment                               | 18       |
| PP2.12  | Repair Welding                               | 19       |
|         |  |          |
| ST3.0   | <b>STRUCTURAL</b>                            | 20       |
| ST3.1   | Codes & Standards                            | 20       |
| ST3.2   | Welding Processes                            | 21       |
| ST3.3   | Weld Procedure Qualification & Documentation | 21       |
| ST3.4   | Welder & Welding Operator Qualification      | 25       |
| ST3.5   | Production Welding                           | 25       |
| ST3.6   | NDT Techniques                               | 27       |
| ST3.7   | NDT Procedures                               | 27       |
| ST3.8   | Extent of NDT Coverage                       | 28       |
| ST3.9   | NDT Acceptance Criteria                      | 29       |
| ST3.10  | NDT Operator                                 | 29       |
| ST3.11  | Advanced Ultrasonic System                   | 29       |
| ST3.12  | NDT Waiting Period                           | 30       |
| ST3.13  | Inspection of Low Fatigue Joints             | 30       |
| ST3.14  | Repair Welding                               | 30       |
|         |  |          |
| PL4.0   | <b>SUBSEA PIPELINE SYSTEM</b>                | 32       |
| PL4.1   | Codes & Standards                            | 32       |
| PL4.2   | Welding Processes                            | 32       |
| PL4.3   | Welding Consumables                          | 33       |
| PL4.4   | Welding Procedure Qualification              | 33       |
| PL4.5   | Welding and Welding Operator Qualification   | 34       |
| PL4.6   | Production Welding                           | 34       |
| PL4.7   | Nondestructive Testing                       | 34       |
| PL4.8   | Repair Welding                               | 36       |
| PL4.9   | Other Material                               | 36       |



**1.0.**

This specification covers the minimum technical requirements for welding & inspection of Piping, Pressure Vessels, Structural & Subsea Pipeline work. For piping, this specification covers CS, CS NACE, SS and Cu-Ni. For piping DSS material welding & NDT, Annexure I shall be referred. This specification modifies and/or supplements the referenced codes that apply to all piping, pressure vessels, structural and pipeline welding. These requirements cover welding done at Contractor's fabrication plant, Contractor's Yard, Vendor / Supplier Premises or field installation, either onshore or offshore. This specification also covers the acceptance standards to be applied to production welds inspected by various NDT Techniques like RT, UT, AUT, MPI & LPT.

**1.1.**

In addition to this specification, Contractor shall also comply with all applicable regulatory and national code requirements.

**1.2.**

|       |   |         |  |
|-------|---|---------|--|
| AISC  | American Institute of Steel Construction    | NDE     | Non Destructive Examination                            |
| API   | American Petroleum Institute                | NDT     | Non Destructive Testing                                |
| ASME  | American Society of Mechanical Engineers    | ONGC    | Oil and Natural Gas Corporation Ltd.                   |
| ASNT  | American Society for Nondestructive Testing | PAUT    | Phased Array Ultrasonic Testing                        |
| ASTM  | American Society for Testing and Materials  | PCN     | Personnel Certification in NDT                         |
| AUT   | Automated Ultrasonic Testing                | PQR     | Procedure Qualification Record                         |
| AWS   | American Welding Society                    | PWHT    | Post Weld Heat Treatment                               |
| BPVC  | Boiler and Pressure Vessel Code             | pWPS    | Preliminary / Proposed Welding Procedure Specification |
| CRA   | Corrosion Resistant Alloy                   | QA      | Quality Assurance                                      |
| CS    | Carbon Steel                                | RT      | Radiographic Testing                                   |
| CTOD  | Crack Tip Opening Displacement              | SMYS    | Specified Minimum Yield Strength                       |
| Cu-Ni | Cupro Nickel                                | SS      | Stainless Steel  |
| DCN   | Design Change Note                          | TMCP    | Thermo Mechanically Controlled Process                 |
| DCR   | Design Change Report                        | TOFD    | Time Of Flight Diffraction                             |
| DNV   | Det Norske Veritas                          | TPI     | Third Party Inspection                                 |
| DSS   | Duplex Stainless Steel                      | UT      | Ultrasonic Testing                                     |
| ECA   | Engineering Critical Assessment             | WPQR    | Welding Procedure Qualification Record                 |
| FCAW  | Flux Cored Arc Welding                      | WPQT    | Welding Procedure Qualification Testing                |
| GMAW  | Gas Metal Arc Welding                       | WPS     | Welding Procedure Specification                        |
| HAZ   | Heat Affected Zone                          | Company | Shall mean ONGC  |
| HRC   | Rockwell Hardness                           |         |  |
| HV 10 | Vicker's Hardness (10 Kg Load)              |         |  |
| ITP   | Inspection & Test Plan                      |         |  |
| LPT   | Liquid Penetrant Testing                    |         |  |
| MPI   | Magnetic Particle Inspection                |         |  |
| NACE  | National Association of Corrosion Engineers |         |  |
| NCR   | Non Conformance Report                      |         |  |

|   |   |   |                                |
|---|---|---|--------------------------------|
|  | <b>Offshore Design Section<br/>Engineering Services<br/>ISO – 9001:2008</b> | <b>FUNCTIONAL<br/>SPECIFICATION FOR<br/>Welding &amp; NDT</b> | <b>Spec. No.</b> 2009F         |
|   |   |   | <b>Rev. No.</b> 8              |
|   |   |   | <b>Discipline</b> QA & Welding |
|   |   |   | <b>Page:</b> 5 OF 36           |

### 1.3.

Before commencing fabrication / installation, the Contractor shall submit a quality plan and a set of fabrication procedures to Company for review and approval. These documents shall include the following minimum requirement:

1. Welding & Consumable Control Procedures,
2. Welder Qualification Procedures,
3. PWHT Procedures and illustration of their proposed areas of application.
4. List of proposed all type of Welding Procedures and their areas of application.
5. List of Qualified all type of Welding Procedures and their areas of application.
6. Material identification & control procedure.
7. Detailed procedures for Non Destructive Testing, Technique sheet & Inspection.
8. Procedures for control of tolerances during fabrication.
9. DCN / DCR Control Procedure
10. Material handling procedure at Fabrication shop, Yard, Offshore installation separately
11. Painting/coating procedure
12. Name of fabrication/NDT agencies involved at Fabrication shop, Yard, Offshore installation with complete address of works & respective activities/job of the project and valid ISO 9001: 2008 certificate.

The quality plan shall include brief details and the sequence of all examinations that will be performed by the Contractor. The names of the individuals responsible for the implementation of all quality assurance and quality control functions shall also be included.

The contractor shall prepare a comprehensive ITP showing the role & scope of various agencies involved in inspection and same shall be submitted for Company's review and approval before commencement of fabrication / installation activity.

Contractor shall be required to do of his own QA internal audit at least 2 times at each yard/offshore activities.

All personnel involved in welding related tasks shall have adequate qualifications and understanding of welding technology. The qualification level shall reflect the tasks and responsibilities of each person in order to obtain the specified quality level. The organization responsible for welding shall nominate at least one authorized welding coordinator in accordance with ISO 14731 – Welding Coordination – Tasks and Responsibilities (or equivalent) to be present on the location where welding is performed. The coordinator shall have comprehensive technical knowledge according to ISO 14731, paragraph 6.2a or equivalent.

The Contractor shall employ sufficient number of qualified inspectors. When an item is ready for inspection, the contractor QA personnel shall inspect it first and should be satisfied before offering the same to the Company inspector.

The contractor shall give tentative inspection schedules in advance so that the Company inspectors can effectively plan for the inspection.

In addition to visual inspection, NDT Techniques like RT, UT (Manual UT, PAUT, AUT & TOFD), MPI & LPT are required to be used for inspection. Radiography shall preferably be with X-ray.

$\gamma$  can be used as explained below. However, use of Cobalt 60 Isotope is not allowed.

RT/PAUT as applicable for Piping & Structural welding( CS & CS NACE) is as follows:

1. The X-ray must be used till 10mm thickness joint of Piping & Structural welding.
2. RT-Gamma ray can be used without separate permission of ONGC, from 11 mm thickness till 25mm for Piping & Structural welding joint. However the "Project specific procedure qualification" is must ..

|                           |                                   |                 |                |                          |
|---------------------------|-----------------------------------|-----------------|----------------|--------------------------|
| FORMAT No.<br>ODS/SOP/004 | Ref. PROCEDURE No.<br>ODS/SOP/023 | ISSUE No.<br>01 | REV. No.<br>00 | REV. DATE:<br>21.07.2010 |
|---------------------------|-----------------------------------|-----------------|----------------|--------------------------|



|   |   |   |                      |                         |
|---|---|---|----------------------|-------------------------|
|  | <b>Offshore Design Section<br/>Engineering Services<br/>ISO – 9001:2008</b> | <b>FUNCTIONAL<br/>SPECIFICATION FOR<br/>Welding &amp; NDT</b> | <b>Spec. No.</b>     | <b>2009F</b>            |
|   |   |   | <b>Rev. No.</b>      | <b>8</b>                |
|   |   |   | <b>Discipline</b>    | <b>QA &amp; Welding</b> |
|   |   |   | <b>Page: 6 OF 36</b> |                         |

3. Beyond 10mm in case of Piping joints, beyond 19 mm in case of Structural joints , the PAUT can be done without separate permission of ONGC . However the “Project specific procedure qualification” is must.

Only personnel certified in accordance with PCN or ASNT recommended practice SNT-TC-1A shall be allowed to carry out Non Destructive Examination. PCN is the preferred qualification.

1.The technique sheet for the referred NDT shall be prepared by the LSTK contractor. The technique sheet preferably should be concise & precise in single page separately for each type of job & each type of NDT method used.

2.The technique sheet along with NDT procedure shall have approval of PCN or ASNT -Level III qualified (respective NDT method) personal of CA /ONGC.

3.The same technique sheet shall be displayed in the laboratory/workplace by the NDT operator.

4.The NDT operator of LSTK contractor must have to demonstrate/ go for the “Project specific procedure qualification” to be witnessed by ONGC/CA/TPI for the 1st time during start of NDT techniques”.

This entire point referred above shall be applicable for all type of NDT method as applicable in piping, pipeline & structural application.

*For standardisation of calibration of instruments used for referred NDT method ,it is essential to have valid calibration certificates for all NDT instruments, Portable Gas detectors, tong tester etc. from NABL accelerated laboratories (India) or from labs which are authorised by local government bodies or from the original manufacturer of the instrument.*

*Further for RT regarding NDT instruments ( RT machine, isotope ) shall require valid permission from the local government-regulatory body at the location of use”*

#### ***Mechanical integrity***

of all flange joints has to be ensured in proper record.

A standard checklist for the activity along with post box-up checkup should be developed & practiced. The checklist shall include the following:

- a) i) Alignment of flanges
  - ii) Inspection of gasket surface for possible defects such as bends or greases.
  - iii) Inspection of mating flanges for dirt, mechanical damage and corrosion. Use suitable solvent to clean the surface. The contact area of flanges shall be free from excess pitting and radial scratches.
  - iv) Ensuring the gasket is properly seated
    - v) Ensuring that fasteners are tightened as per tightening procedures and using specific values with well maintained tools and torque wrenches.
- b) Each joint shall be boxed up and tightened by only skilled technician.
- c) Ensuring right type of gaskets & fasteners etc. confirming to the specifications.
- d) Ensuring that the stud & nuts are free of dirt and corrosion. The studs should be straight and threads free from nicks, burr and chips etc.
- e) Checking of individual joint for any leak during commissioning/ pressure testing by special tapes, soap solution or as per relevant code.”

in lieu of film radiography can be used with the permission from ONGC on submission & approval of following documents.

- 1.Past track record of the technology/vendor in offshore application on similar material (Parent & welding consumable). PO copy & performance report of the user is required.
- 2.Complete procedure of using the technology with specification, protection of 1<sup>st</sup> image, calibration, validation of software, Technique etc. with respect to all the relevant standard.
3. The specific training & “procedure qualification “on the subject is required to be provided to ONGC/CA/TPI free of cost.
4. For storage of data a dedicated PC of sufficient memory for entire project with viewing software etc. must be provided without extra cost to ONGC..
5. Optimum nos. of re-use of film is restricted to 150 nos. or damaged whichever is earlier..

|                           |                                   |                 |                |                          |
|---------------------------|-----------------------------------|-----------------|----------------|--------------------------|
| FORMAT No.<br>ODS/SOP/004 | Ref. PROCEDURE No.<br>ODS/SOP/023 | ISSUE No.<br>01 | REV. No.<br>00 | REV. DATE:<br>21.07.2010 |
|---------------------------|-----------------------------------|-----------------|----------------|--------------------------|

|   |   |   |                      |                         |
|---|---|---|----------------------|-------------------------|
|  | <b>Offshore Design Section<br/>Engineering Services<br/>ISO – 9001:2008</b> | <b>FUNCTIONAL<br/>SPECIFICATION FOR<br/>Welding &amp; NDT</b> | <b>Spec. No.</b>     | <b>2009F</b>            |
|   |   |   | <b>Rev. No.</b>      | <b>8</b>                |
|   |   |   | <b>Discipline</b>    | <b>QA &amp; Welding</b> |
|   |   |   | <b>Page: 7 OF 36</b> |                         |

*ISO QMS 9001: 2008 – valid certification of all the agencies/ subcontractors engaged (by LSTK contractors) for NDT and fabrication/welding activities shall be required.”*

It shall be the responsibility of the contractor to inspect all materials upon receipt and to ensure that the correct grade of material has been supplied and that identification, dimensions, material quality and end preparation are in accordance with the requisite standards and specifications. Different materials shall be kept in discrete sections of the storage area and all material shall be marked in a manner that allows it to be related to the original manufacturer’s certification.

Procedures for the transfer of material identification marks shall be agreed with the Company prior to the commencement of fabrication. Any material which is not readily identifiable shall be removed from the worksite and quarantined until its material grade and source can be confirmed.

Welding shall not be performed when the ambient temperature is lower than zero degree C, when surfaces are wet or exposed to rain, snow or high wind velocities, when welders are exposed to inclement conditions, or when conditions prevent required inspections.

Only welding equipment that is in good working condition and that is properly grounded shall be used. All welding machines shall be calibrated prior to commencement of fabrication and calibration certificates shall be available for ONGC QA audits. Certification shall be valid for 6 month periods, or as per manufacturer’s recommendation.

*All the welding machines/transformers shall be based of **Inverter technology** or better one instead of conventional transformer/rectifiers based one.*

**All welding machines shall be calibrated** prior to commencement of fabrication from NABL accelerated laboratories (India) or from labs which are authorised by local government bodies of from the original manufacturer of the machines.

*All the welding cables, Grinder cables shall be free from any intermittent joints and shall have proper industrial explosion proof electrical plug-top. All used pipes for Gas- cutter shall be in good conditions with armoured & quality stamped.*

:

- Each welding machine and panels shall be individually grounded to the platform or portion of the platform being welded.
- No machine or panels shall be grounded to floating equipment during welding on the structure.

Arc strikes should be made in weld groove. Arc strikes on the surface of base metal shall be removed by grinding, including any hardened zone beneath the strike. Any such repair shall be visually and magnetic particle inspected.

|                           |                                   |                 |                |                          |
|---------------------------|-----------------------------------|-----------------|----------------|--------------------------|
| FORMAT No.<br>ODS/SOP/004 | Ref. PROCEDURE No.<br>ODS/SOP/023 | ISSUE No.<br>01 | REV. No.<br>00 | REV. DATE:<br>21.07.2010 |
|---------------------------|-----------------------------------|-----------------|----------------|--------------------------|

|   |   |   |               |              |
|---|---|---|---------------|--------------|
|  | <b>Offshore Design Section<br/>Engineering Services<br/>ISO – 9001:2008</b> | <b>FUNCTIONAL<br/>SPECIFICATION FOR<br/>Welding &amp; NDT</b> | Spec. No.     | 2009F        |
|   |   |   | Rev. No.      | 8            |
|   |   |   | Discipline    | QA & Welding |
|   |   |   | Page: 8 OF 36 |              |

Company shall approve all consumables including brands. Welding Consumables shall have physical, chemical, fatigue and corrosion resistance properties comparable to base metal. Manufacturer's batch test certificate shall be submitted for each batch of consumables used. Test results shall include chemical, physical (including impact), corrosion resistance (if welding material for sour service application or with NACE requirements) & fracture toughness (if welding material or WPS with CTOD Requirements). If these batch test results are not readily available (like corrosion test results, fracture toughness etc.), contractor shall carry out additional batch testing to confirm the same.

*The welding consumables which shall not be in no case of a date manufacture older than one year with effect from date of starting the fabrication.*

*Apart from above, prior to Production welding, the contractor has to do HIC test separately for welding consumables as guided by CA or Company."*

The control of Welding Consumables shall be in accordance with a well documented procedure. This procedure shall include techniques for storage, handling, recycling and re-baking of welding consumables to ensure that the diffusible Hydrogen content of weld metal is maintained at less than 5ml per 100 g of weld metal. The procedure shall, as a minimum, be in accordance with the manufacturer's recommendations. Since a variety of welding consumables may be in use at any manufacturing location, strict control shall be exercised to prevent loss of identification or the use of incorrect weld metal.

***Miscellaneous requirement***

The welder and weld area shall be provided with protection during periods of inclement weather and/or excessive wind conditions. The procedures shall include means of protecting electrodes, wires, fluxes, etc. Good House Keeping is essential in the job-area

Gas shielded welding processes should generally be used only for shop fabrication or in enclosed conditions. When used outdoor, suitable windshields must be provided to allow adequate gas coverage of molten puddle.

Heated quivers or rod boxes shall be placed at each welding location when low hydrogen welding electrodes are used.

The implementation of the procedures will be audited by ONGC QA team during the phase of Design, Fabrication & Installation activity at least two times par phase. Apart from audit the surprise checking also may be carried out by ONGC QA team at any time. ONGC shall be informed about the timely corrective actions taken by the fabricator as a result of any CAR/NCRs issued during such audit.

Copies of various QA procedures shall be readily available and shall be referenced in the quality plan and shall be made available during QA audit by Company.

Welders and welding operators shall be qualified as per the applicable specification. When using welding processes which have high potential for non-fusing type defects, in addition to the NDT requirements specified in the respective Codes, bend test shall also be carried out. GMAW and FCAW are regarded as welding processes with high potential for non-fusing type defects.

Welder Qualification Tests shall be witnessed by Company representative and/or by a reputed TPI agency. The Company representative shall be advised in advance that the Contractor is conducting welder qualification to enable auditing of test facilities.

|                           |                                   |                 |                |                          |
|---------------------------|-----------------------------------|-----------------|----------------|--------------------------|
| FORMAT No.<br>ODS/SOF/004 | Ref. PROCEDURE No.<br>ODS/SOP/023 | ISSUE No.<br>01 | REV. No.<br>00 | REV. DATE:<br>21.07.2010 |
|---------------------------|-----------------------------------|-----------------|----------------|--------------------------|

|   |   |   |                      |                         |
|---|---|---|----------------------|-------------------------|
|  | <b>Offshore Design Section<br/>Engineering Services<br/>ISO – 9001:2008</b> | <b>FUNCTIONAL<br/>SPECIFICATION FOR<br/>Welding &amp; NDT</b> | <b>Spec. No.</b>     | <b>2009F</b>            |
|   |   |   | <b>Rev. No.</b>      | <b>8</b>                |
|   |   |   | <b>Discipline</b>    | <b>QA &amp; Welding</b> |
|   |   |   | <b>Page: 9 OF 36</b> |                         |

Qualification test welds shall be made on test coupons prepared in accordance with the relevant standard. Certified as per QA1.3.4, the “Amp/volt tong tester” shall be available at the Contractor’s establishment at all times.

The Contractor shall be responsible for all costs, including labor and laboratory testing, associated with welder qualification tests and retests.

All welders working on the project shall wear identification cards made at contractor’s cost which shall contains photograph, welders name, welder no. Procedure qualified and Company’s/Engineer’s representative’s signature. If the fabricator has a different system for welder’s identity card, same can be followed after agreement.

The period of validity of welder qualification shall be in accordance with the Standard used for qualification. A qualification can be cancelled if the welder / welding operator show inadequate skill, knowledge and performance.

No wooden planks shall be used in any stage of fabrication job as platform of scaffolding.

During fabrication at yard there must have two independent escape route for workers..

At all stages of fabrication, the Contractor shall maintain all relevant production records using a recording system agreed by the Company. The records shall include:

1. Material & Welding consumable certificates.
2. PWHT Records.
3. Fit-up reports.
4. Weld visual reports.
5. Painting/top coat report with surface finish report.
6. Dimensional inspection together with NDE & pressure test records.
7. Welder & welding operator qualification.
8. Approved Isometric drawings marked with unique weld numbers / NDT Drawings.
9. Authenticated copies of NDT operator’s certificates.
10. Records of any agreed deviations to the fabrication standards.

Welding Procedures shall be tested to demonstrate that acceptable welds can be made by the procedure. During WPS Qualification, the quality of welds shall be determined by both non-destructive & destructive testing as per the applicable code. Additional testing requirements specified in this specification shall also be carried out. The Welding Procedure Qualification Testing (WPQT) shall be witnessed by Company representative and also by a reputed TPI agency. Only qualified and approved WPSs shall be used for production welding.

1. Material subjected for CTOD Testing shall be tested and shall meet or exceed CTOD value of 0.35mm.
2. Welding consumable subjected for CTOD Testing shall be tested and shall meet or exceed CTOD value of 0.25mm.
3. WPS subjected for CTOD testing shall be tested and shall meet or exceed CTOD value of 0.20 mm.
4. CTOD testing shall be done from Govt. labs or Govt. accelerated labs with prior information to ONGC.



The following Codes shall be the minimum acceptable standards for welding and inspection during piping & pressure vessel fabrication. The latest edition, addenda, code cases and supplement available at the time of bidding will be used. Any part of any other non-listed code referred to in these listed codes as augmentation is to be considered applicable.

|                              |   |
|------------------------------|---|
| ASME B31.3                   | Process Piping  |
| ASME B31.4                   | Pipeline Transportation System for Liquid Hydrocarbons and other Liquids  |
| ASME B31.8                   | Gas Transmission and Distribution Piping System   |
| ASME BPVC Sec.VIII,<br>Div.1 | Rules for Construction of Pressure Vessels  |
| AWS A2.4                     | Standard Symbols for Welding, Brazing and Nondestructive Examination.   |
| ASME BPVC Sec.IX             | Welding & Brazing Qualification   |
| NACE MR0175                  | Standard Material Requirements - Metals for Sulfide Stress Cracking and Stress Corrosion Cracking Resistance in Sour Oilfield Environments      |
| NACE TM0284                  | Standard Test Method - Evaluation of Pipeline and Pressure Vessel Steels for Resistance to Hydrogen-Induced Cracking                            |
| NACE TM0177                  | Standard Test Method - Laboratory Testing of Metals for Resistance to Sulfide Stress Cracking and Stress Corrosion Cracking in H2S Environments |
| ASME BPVC Sec. V             | Nondestructive Examination  |
| ASME Sec. II, Part C         | Specification for Welding Rods, Electrodes and Filler Metals  |
| ASTM E164                    | Standard Practice for Contact Ultrasonic Testing of Weldments   |
| ASTM E165                    | Practice for Liquid Penetrant Inspection Methods  |
| ASTM E709                    | Practice for Magnetic Particle Examination  |
| ASTM E94                     | Standard Guide for Radiographic Examination   |
| ASTM E384                    | Standard Test Method for Knoop and Vickers Hardness of Materials  |
| ISO 14731                    | Welding Coordination – Tasks and Responsibilities   |
| ASNT SNT-TC-1A               | Personnel Qualification and Certification in Nondestructive Testing   |
|                              |   |

|   |   |                       |                         |
|---|---|-----------------------|-------------------------|
|  <b>Offshore Design Section<br/>Engineering Services<br/>ISO – 9001:2008</b> | <b>FUNCTIONAL<br/>SPECIFICATION FOR<br/>Welding &amp; NDT</b> | <b>Spec. No.</b>      | <b>2009F</b>            |
|   |   | <b>Rev. No.</b>       | <b>8</b>                |
|   |   | <b>Discipline</b>     | <b>QA &amp; Welding</b> |
|   |   | <b>Page: 11 OF 36</b> |                         |

The Contractor shall not commence production welding until appropriately qualified welding procedures have been accepted by the Company.

Weld procedures including brazing procedures shall be qualified as per ASME Code Section IX & ASME B31.3

*The applicable WPQT (Welding Procedure Qualification Testing) was done in **last 2 years for ONGC Job** dated with effect from date of starting fabrication. If it is not of ONGC project, it shall be fresh WPQT for project specific.”*

Such previously qualified welding procedures may be considered for use for CS & CS NACE Piping, where they comply with the present document and are appropriate to the scope of work. These WPSs should have been qualified by the same fabricator in the presence of reputed TPI agencies. New, project specific WPS shall be prepared using the old WPQT as explained above of earlier qualified WPSs as supporting documents. In this exercise, good engineering practice and guidelines given in ASME Sec. IX shall be followed and using PQRs in an arbitrary manner to support a new WPS will not be acceptable.

However, for critical applications involving the welding of CRA materials (SS, DSS, Cu-Ni, Cu etc.), previously qualified procedures are not acceptable and fresh project specific WPQT & WPS is required.

Mechanical testing of WPQT coupons for CS piping shall confirm to the requirements of ASME Sec.IX / ASME B31.3. In addition to the above requirement, hardness testing shall be performed on each test coupon. Maximum hardness value shall be 325 HV10 for normal service piping. For Sour Service piping, a maximum permitted hardness of 248 HV10 (22 HRC) shall apply. CVN (Charpy V Notch) Impact Testing of Carbon Steel Pipe work shall be performed in accordance with ASME B31.3 Table 323.2.2.

For each welding process, the welding procedures shall specify all equipment settings. The Contractor’s Welding Supervisor shall check daily and record machine settings for each weld procedure used during welding activities. This record shall be available for audit by the Company representative.

Welding Procedures shall be qualified as per ASME Sec. IX & ASME BPVC Sec. VIII Div.I

|                           |                                   |                 |                |                          |
|---------------------------|-----------------------------------|-----------------|----------------|--------------------------|
| FORMAT No.<br>ODS/SOP/004 | Ref. PROCEDURE No.<br>ODS/SOP/023 | ISSUE No.<br>01 | REV. No.<br>00 | REV. DATE:<br>21.07.2010 |
|---------------------------|-----------------------------------|-----------------|----------------|--------------------------|



|   |   |   |                       |                         |
|---|---|---|-----------------------|-------------------------|
|  | <b>Offshore Design Section<br/>Engineering Services<br/>ISO – 9001:2008</b> | <b>FUNCTIONAL<br/>SPECIFICATION FOR<br/>Welding &amp; NDT</b> | <b>Spec. No.</b>      | <b>2009F</b>            |
|   |   |   | <b>Rev. No.</b>       | <b>8</b>                |
|   |   |   | <b>Discipline</b>     | <b>QA &amp; Welding</b> |
|   |   |   | <b>Page: 12 OF 36</b> |                         |

Welders shall be qualified as per ASME Boiler and Pressure Vessel Code, Section IX.

Qualification on production welds is not permitted.

A welder shall not be permitted to weld on pipe work or attachments to pipe work unless they are qualified to the procedure in use and the documentary evidence has been sighted by the Company representative.

Tack welds shall be made by a qualified welder using the same type of electrode as is used for the root pass.

The Company may request a retest of any welder at any time and from time to time during the work. If a welder fails to qualify, then at the discretion of the company representative, all non- installed welds completed by that welder shall be examined by additional radiographic tests, over and above that which would normally be required or specified in the drawings for that pipe work and the same shall be charged to the Contractor's account.

Welds not identified and recorded, or welded by unqualified welders, shall automatically be rejected. It will be the Contractor's responsibility to prove that the welds conform to the applicable Specification. This may require 100% radiography.

1. The quality of piping welding shall be such that a weld efficiency factor as defined in ASME B 31.3 of 1.0 is achieved.
2. The deposited filler metal shall match the chemistry, corrosion resistance (if required) and minimum physical properties of the parent metal when similar metals are welded.
3. Circumferential welds on pipes shall be staggered at least four times the pipe wall thickness or 25 mm, whichever is greater, apart.
4. Branch connections shall be joined to their headers with full penetration welds.
5. Backing rings, back-up rings or chill rings shall not be used.

|                           |                                   |                 |                |                          |
|---------------------------|-----------------------------------|-----------------|----------------|--------------------------|
| FORMAT No.<br>ODS/SOF/004 | Ref. PROCEDURE No.<br>ODS/SOP/023 | ISSUE No.<br>01 | REV. No.<br>00 | REV. DATE:<br>21.07.2010 |
|---------------------------|-----------------------------------|-----------------|----------------|--------------------------|

|   |   |                       |                         |
|---|---|-----------------------|-------------------------|
|  <b>Offshore Design Section<br/>Engineering Services<br/>ISO – 9001:2008</b> | <b>FUNCTIONAL<br/>SPECIFICATION FOR<br/>Welding &amp; NDT</b> | <b>Spec. No.</b>      | <b>2009F</b>            |
|   |   | <b>Rev. No.</b>       | <b>8</b>                |
|   |   | <b>Discipline</b>     | <b>QA &amp; Welding</b> |
|   |   | <b>Page: 13 OF 36</b> |                         |

6. Back or seal welding of screwed fittings is prohibited unless specified in the drawing or is part of the approved welding procedure.
7. Oxy-acetylene torches shall not be used for pre-heating.
8. Pipes of dissimilar materials shall not be welded to each other but shall be flanged unless otherwise approved.
9. Compressor and turbine piping, including lube and seal oil piping, and other piping requiring special cleaning as shown in the drawings provided by the supplier shall have the root pass deposited by the gas tungsten arc process. The backside of the root pass shall be purged with inert gas.
10. If the bore of the pipe is different from the bore of fittings or flanges, to which it is welded, by more than 3mm (total bore diameter), the thicker member shall be bored, taper bored or ground smooth to match the specified bore. Figure 328.4.3 of ASME B 31.3 will governs the geometry of all taper boring and beveling.
11. Coupling or other weld-on type branch connection shall be located at least 80 mm away from any weld joint.
12. When socket weld fittings or valves are used, pipe shall be spaced approximately 1/16 inch to avoid “bottoming” which could result in excessive welds stress.
13. The inside of the brazed fitting and outside of the tube shall be cleaned with sand Paper. Flux paste to be evenly applied to the joint.
14. Reinforcing pads shall be added only after external and internal visual inspection of the attachment. Reinforcing pads shall be provided with ¼” tapped weep hole. Weep holes should be plugged after welding of pads is over.
15. Exposed machined and threaded surfaces shall be protected from oxidation during heat treatment.
16. Flange bolt holes shall straddle the established horizontal and vertical centerlines of the pipe except where connection to equipment dictates otherwise.
17. Cleaning of the piping after fabrication and heat treatment shall be performed externally and internally to remove all loose scale, weld spatter, sand and other foreign materials.

|                           |                                   |                 |                |                          |
|---------------------------|-----------------------------------|-----------------|----------------|--------------------------|
| FORMAT No.<br>ODS/SOF/004 | Ref. PROCEDURE No.<br>ODS/SOP/023 | ISSUE No.<br>01 | REV. No.<br>00 | REV. DATE:<br>21.07.2010 |
|---------------------------|-----------------------------------|-----------------|----------------|--------------------------|



|   |   |                       |                         |
|---|---|-----------------------|-------------------------|
|  <b>Offshore Design Section<br/>Engineering Services<br/>ISO – 9001:2008</b> | <b>FUNCTIONAL<br/>SPECIFICATION FOR<br/>Welding &amp; NDT</b> | <b>Spec. No.</b>      | <b>2009F</b>            |
|   |   | <b>Rev. No.</b>       | <b>8</b>                |
|   |   | <b>Discipline</b>     | <b>QA &amp; Welding</b> |
|   |   | <b>Page: 14 OF 36</b> |                         |

18. Welding shall not be done when quality of completed weld would be impaired by prevailing weather conditions, air borne moisture, blowing sand or high winds. Windshields may be used when practical.
19. Temporary attachments to the outside of surface of the pipe shall not be made without the approval of Company. Any such attachments which are permitted shall be removed by grinding or by using Oxy – Acetylene torch to 3 mm above permanent material surface, removal of the remaining 3mm shall be by grinding, followed by MPI / DPI. Company may require an ultrasonic check to establish that the remaining wall thickness is not less than the design minimum. Arc air gouging, hammering or other mechanical means shall not be used for the removal of temporary attachments.
20. Welder shall be supplied with temple stick – thermal crayons or pended gauges so that welders and inspector can check and control the temperature of element.
21. No weld shall be coated, painted, hydro tested before it has been inspected and accepted.
22. No weld is to be cooled by quenching or by any means other than natural cooling.
23. Welding for Severe Cyclic Condition: The weld reinforcement shall be smooth and shall blend smoothly with the external surface of the pipe to minimize possible stress concentration effects.
24. Field Welding
- Where field welds are designated, the prefabricated pipe shall be cut off 150 mm longer than the dimensions shown on the pipe fabrication drawings to allow for modification then precise fit-up in place.
  - Additional field fit welds may be included in a spool by the Contractor for those spots which may have restricted site access or which may be cumbersome for transportation.
  - The location of field welds, where not indicated on the drawings, will be the responsibility of the Contractor.

NDT Techniques like RT, UT, MPI & LPT shall be used for the examination of welds as per the requirements given in this specification.

|                           |                                   |                 |                |                          |
|---------------------------|-----------------------------------|-----------------|----------------|--------------------------|
| FORMAT No.<br>ODS/SOF/004 | Ref. PROCEDURE No.<br>ODS/SOP/023 | ISSUE No.<br>01 | REV. No.<br>00 | REV. DATE:<br>21.07.2010 |
|---------------------------|-----------------------------------|-----------------|----------------|--------------------------|

|   |   |   |                       |                         |
|---|---|---|-----------------------|-------------------------|
|  | <b>Offshore Design Section<br/>Engineering Services<br/>ISO – 9001:2008</b> | <b>FUNCTIONAL<br/>SPECIFICATION FOR<br/>Welding &amp; NDT</b> | <b>Spec. No.</b>      | <b>2009F</b>            |
|   |   |   | <b>Rev. No.</b>       | <b>8</b>                |
|   |   |   | <b>Discipline</b>     | <b>QA &amp; Welding</b> |
|   |   |   | <b>Page: 15 OF 36</b> |                         |

1. Radiography will be performed for every pipe thickness and material grouping and for each welding process and procedure, progressively throughout entire job. At least one of each type and position of weld made by each welder will be examined. A record shall be kept by the Contractor of the quality and extent of each welder's work.
2. Radiography is not required for the welds on slip-on flanges or socket welds or seal welds.
3. Fluorescent intensifying screens such as calcium tungsten shall not be used.
4. For each weld found to be defective two additional welds made by the same welder who produced the defective weld will be subjected to radiographic examination. These additional examinations will be made immediately after the defective welds is found and are in addition to the minimum examination requirements for the line class as specified in the drawings or specifications.
5. Weld repairs shall be re-examined by the same method used to detect the original defect.

Contractor shall prepare NDT Procedures covering all aspects of the work. NDT Procedures shall be submitted to the Company representative for review and approval. Written NDT Procedures shall be qualified as per the requirements of ASME Sec. V, in the presence of Company representative. Qualification of the NDT procedures shall be required before NDT can be performed on production welds.

**A. Piping**

NDT Procedures shall be prepared as per the requirements of ASME B31.3, ASME Section V and the applicable ASME Code Cases.

**B. Pressure Vessels**

NDT Procedures shall be prepared as per the requirements of ASME BPVC Sec. VIII Div.1 and ASME Sec. V

|                           |                                   |                 |                |                          |
|---------------------------|-----------------------------------|-----------------|----------------|--------------------------|
| FORMAT No.<br>ODS/SOF/004 | Ref. PROCEDURE No.<br>ODS/SOP/023 | ISSUE No.<br>01 | REV. No.<br>00 | REV. DATE:<br>21.07.2010 |
|---------------------------|-----------------------------------|-----------------|----------------|--------------------------|



- I. Random radiography (10%) shall be performed covering on one weld in each 10 welds for each welder on the following:
1. Water ( in case of carbon steel)
  2. Air
  3. Chemical
  4. Diesel
  5. Closed & Open drain
  6. Relief
  7. Hydraulic Oil
  8. Oily water
  9. Glycol & Thermoil
  10. Vent gas
  11. Lube oil & Seal oil
- II. 100% Radiography shall be performed on size 2” and above and 10% on below 2” for the following:
1. Crude oil
  2. Jet fuel
  3. Fuel gas / instrument gas
  4. Process gas
  5. Production flow lines ( well fluid)
  6. Injection water
  7. Hydrocarbon (process)
  8. Water ( in case of 90/10 Cu-Ni)
  9. H.P. and L.P. Flare lines.
  10. Piping system not covered under any of the above services
- III. For fillet welds and brazed joints where carrying out radiography is not possible, magnetic particle test or dye penetrant test shall be carried out. The extent of inspection shall remain same as for radiography.

All the lines which are stress relieved or have design pressure more than 50 Kg/ cm<sup>2</sup> shall be radiographed for 100% of weld joints even if not required as per I to III

Field welded joints, which cannot be leak tested due to unavoidable circumstances & reasons shall be 100 % examined by RT and MPI/LPT.

|   |   |                       |                         |
|---|---|-----------------------|-------------------------|
|  <b>Offshore Design Section<br/>Engineering Services<br/>ISO – 9001:2008</b> | <b>FUNCTIONAL<br/>SPECIFICATION FOR<br/>Welding &amp; NDT</b> | <b>Spec. No.</b>      | <b>2009F</b>            |
|   |   | <b>Rev. No.</b>       | <b>8</b>                |
|   |   | <b>Discipline</b>     | <b>QA &amp; Welding</b> |
|   |   | <b>Page: 17 OF 36</b> |                         |

In addition to the requirements mentioned above, for welded joints of NACE material, 100 % hardness test shall also be carried out.

Welds, which cannot be radiographed because of their location, inaccessibility, excessive & impractical radiographic exposure time required or due to safety reasons, can be examined by ultrasonic and / or liquid penetrant / magnetic particle method as applicable with permission from Company. The extent of inspection shall be the same as for radiography

NDT Coverage shall be as per the requirements given in ASME BPVC Sec.VIII Div.I and the design documents.

NDT Operator Qualification & experience records shall be submitted for Company's review. NDT Operators shall be minimum Level II qualified, PCN qualification is preferred. Skill levels of NDT Operators shall be further examined by Company through practical mock tests & written examination. Contractor shall make necessary arrangements for the same with no additional cost to Company.

PAUT (Phased Array Ultrasonic Testing) can be used for the examination of CS & CS NACE piping welded joints with thickness beyond 10 mm for which separate permission from Company is not required. However *"Project specific procedure qualification"* to be witnessed by *ONGC/CA/TPI for the 1<sup>st</sup> time during start of NDT techniques..*

The permission to use PAUT will be subject to satisfying the following conditions:

1. Past track record of the agency performing PAUT shall be submitted for Company's review and approval.
2. Written PAUT Procedure shall be prepared as per the applicable code and shall be submitted for Company's review and approval.
3. PAUT Procedure shall be demonstrated and qualified as per the Code requirements and to the satisfaction of the Company in the presence of Company Representative. During the demonstration, it shall be established that the scanning technique employed covers the entire weld volume and HAZ.
4. NDT Operator Qualification records (minimum level II) including experience in PAUT shall be submitted for Company's review and approval.
5. Skill levels of NDT Operators will be further examined through practical mock tests and written tests. Contractor shall make the necessary arrangements for the same with no additional cost to Company.
6. Familiarisation and interpretation Training on PAUT shall be provided to Company's inspectors as and when required with no cost to ONGC.

|                           |                                   |                 |                |                          |
|---------------------------|-----------------------------------|-----------------|----------------|--------------------------|
| FORMAT No.<br>ODS/SOF/004 | Ref. PROCEDURE No.<br>ODS/SOP/023 | ISSUE No.<br>01 | REV. No.<br>00 | REV. DATE:<br>21.07.2010 |
|---------------------------|-----------------------------------|-----------------|----------------|--------------------------|



7. For any ambiguous indication observed in PAUT, especially in the case of volumetric discontinuities, if ONGC desires, RT of that joint shall be carried out without any additional cost to ONGC.
8. Soft copy of scan data (A-Scan, C-Scan, Sector Scan etc.) of each joint along with the software for viewing the same shall be submitted to ONGC.

| Technique | Material               | Acceptance Criteria              |
|-----------|------------------------|----------------------------------|
| RT        | CS , SS                | ASME B31.3                       |
|           | CS NACE, Cu-Ni         | ASME BPVC Sec.VIII Div. I, UW 51 |
| UT        | CS, CS NACE            | ASME B31.3                       |
| PAUT      | CS, CS NACE            | ASME B31.3 & Code Case 181       |
| MPI       | CS, CS NACE            | ASME B31.3                       |
| LPT       | CS, CS NACE, SS, Cu-Ni | ASME B31.3                       |

- a. Internal weld protrusion in pigged lines shall not exceed 1.6 mm.
- b. Orifice flange butt weld shall be internally ground smooth and flush.

**ASME BPVC Sec. VIII Div.1**

1. Preheat and post-weld heat treatment (PWHT) shall be in accordance with ASME B 31.3. ASME B31.4,ASME B31.8 or ASME BPVC Sec.VIII, Div.I, as applicable.
2. The method and equipment used in heat treatment shall be acceptable to the Company.
3. All threaded connections shall be protected from oxidation during heat treatment and be chased or gauge checked after heat treatment.
4. Exposed machined and threaded surfaces shall be protected from oxidation during heat treatment.
5. Cleaning of pipe work after fabrication and heat treatment shall be performed, externally and internally to remove all loose scale, weld spatter, sand and other foreign materials.

|   |   |   |                       |                         |
|---|---|---|-----------------------|-------------------------|
|  | <b>Offshore Design Section<br/>Engineering Services<br/>ISO – 9001:2008</b> | <b>FUNCTIONAL<br/>SPECIFICATION FOR<br/>Welding &amp; NDT</b> | <b>Spec. No.</b>      | <b>2009F</b>            |
|   |   |   | <b>Rev. No.</b>       | <b>8</b>                |
|   |   |   | <b>Discipline</b>     | <b>QA &amp; Welding</b> |
|   |   |   | <b>Page: 19 OF 36</b> |                         |

6. For all welds requiring PWHT, the specified inspection and NDT shall be performed after completion of PWHT process but not before the welds have cooled to ambient temperature. NDT prior to PWHT, performed in addition to mandatory NDT following PWHT, shall be at the discretion of the Contractor. However, where defects requiring repair are located by this inspection, it shall be brought to the notice of Company.
7. Machined surfaces shall be protected by a suitable paint or compound to prevent damage from scaling during PWHT.
8. After final heat treatment, the Contractor shall identify the piping as having received PWHT. The method of identification shall be recorded on the as-built isometric and P&ID together with the other recorded information.
9. A legible heat treatment chart shall be provided to the Company. This chart must show the rate of increase of temperature, the holding temperature and time and the rate of decrease of temperature.

If the company representative considers a weld to be grossly defective, it shall be cut out and the joint re-welded and all costs associated therewith shall be the Contractor's responsibility.

Mechanical defects such as scratches and gouges may be ground smooth provided the depth of the defect does not exceed 10% of the nominal wall thickness of the pipe.

Repair welding shall only be carried out in accordance with an approved repair procedure. Minimum Pre-heat for repair welding shall be 50<sup>0</sup>C more than that used for production welding.

After gouging to remove the defects, the area shall be ground smooth and shall be examined with MPI to ensure that the entire defect has been removed. LPT shall be used for non-ferromagnetic materials. As a minimum, completed repairs shall be examined by the same NDT methods used for the original weld.

Only two times repairs are allowed on any welded joint.

Dents or grooves whose depth is greater than 10% of the nominal pipe wall thickness shall be removed by cutting out and replacing that length of pipe in which the defect occurs. The minimum length of a cutout shall be four times the nominal diameter or 150 mm, whichever is the lesser.

Internal weld metal projecting into the pipe on weld neck orifice flanges shall be removed and ground smooth with the pipe.

|                           |                                   |                 |                |                          |
|---------------------------|-----------------------------------|-----------------|----------------|--------------------------|
| FORMAT No.<br>ODS/SOF/004 | Ref. PROCEDURE No.<br>ODS/SOP/023 | ISSUE No.<br>01 | REV. No.<br>00 | REV. DATE:<br>21.07.2010 |
|---------------------------|-----------------------------------|-----------------|----------------|--------------------------|



The following Codes shall be the minimum acceptable standards for welding and inspection during Structural Fabrication. The latest edition, addenda, and supplement available at the time of bidding will be used. Any part of any other non-listed code referred to in these listed codes as augmentation is to be considered applicable.

|                      |   |
|----------------------|---|
| AWS D1.1             | Structural Welding Code - Steel   |
| AWS D1.3             | Structural Welding Code – Sheet Steel   |
| AWS A2.4             | Standard Symbols for Welding, Brazing and Nondestructive Examination.   |
| AISC                 | Manual of Steel Construction – Allowable Stress Design. Specification for Structural Steel Buildings  |
| API RP 2A            | Recommended Practice for Planning, Designing and Constructing fixed Offshore Platforms – Working Stress Design  |
| API Spec. 2B         | Specification for Fabricated Structural Steel Pipe  |
| API RP 2X            | Recommended Practice for Ultrasonic & Magnetic Particle Examination of Offshore Structural Fabrication and Guidelines for Qualification of Ultrasonic Technicians |
| ASME BPVC Sec. V     | Nondestructive Examination  |
| ASME Sec. II, Part C | Specification for Welding Rods, Electrodes and Filler Metals  |
| ASTM E164            | Standard Practice for Contact Ultrasonic Testing of Weldments   |
| ASTM E165            | Practice for Liquid Penetrant Inspection Methods  |
| ASTM E709            | Practice for Magnetic Particle Examination  |
| ASTM E94             | Standard Guide for Radiographic Examination   |
| ASTM E384            | Standard Test Method for Knoop and Vickers Hardness of Materials  |
| BS7448               | Fracture Mechanics Toughness Tests  |
| EEMUA158             | Construction Specification for Fixed Offshore Structures in the North Se  |
| ASNT SNT-TC-1A       | Personnel Qualification and Certification in Nondestructive Testing   |
| ISO 14731            | Welding Coordination – Tasks and Responsibilities   |

|   |   |   |                       |                         |
|---|---|---|-----------------------|-------------------------|
|  | <b>Offshore Design Section<br/>Engineering Services<br/>ISO – 9001:2008</b> | <b>FUNCTIONAL<br/>SPECIFICATION FOR<br/>Welding &amp; NDT</b> | <b>Spec. No.</b>      | <b>2009F</b>            |
|   |   |   | <b>Rev. No.</b>       | <b>8</b>                |
|   |   |   | <b>Discipline</b>     | <b>QA &amp; Welding</b> |
|   |   |   | <b>Page: 21 OF 36</b> |                         |

Only Gas Metal Arc (GMAW), Gas Tungsten Arc (GTAW), Submerged Arc (SAW), Shielded Metal Arc (SMAW), or Flux Cored Arc (FCAW) welding process shall be used for production welding. Other welding processes shall not be used. Automatic stud welding machines can be used for welding of studs to steel (for fixing insulation etc.).

Use of GMAW process shall be limited to the following:

- a) GMAW welding shall not be exposed to air drafts greater than 8 Km/h.
- b) GMAW-S can be used for groove welds in materials 10 mm or less using a procedure qualified by the contractor.
- c) GMAW-S can be used for fillet welds of 20 mm or less
- d) GMAW-S may be used for the root pass only in combination with SAW welding, and for the root pass in non-critical joint applications.
- e) Spray transfer mode of metal deposition for GMAW is limited to the flat position. f)

Weld areas shall be blasted or ground to white metal prior to welding when GMAW or GMAW-S is used.

to the following:

- a) FCAW welding with external gas shielding shall not be exposed to air drafts greater than 8 Km/h.
- b) Electrode diameters greater than 3 mm are not acceptable.
- c) Self – shielded flux core shall not be used as root or fill pass beneath other processes.
- d) *FCAW welding shall not be used at any case for piping & structural welding during installation or otherwise in offshore environment.”*

The Contractor shall not commence production welding until appropriately qualified welding procedures have been accepted by the Company. All weld procedures to be utilized on this project shall be qualified.

|                           |                                   |                 |                |                          |
|---------------------------|-----------------------------------|-----------------|----------------|--------------------------|
| FORMAT No.<br>ODS/SOF/004 | Ref. PROCEDURE No.<br>ODS/SOP/023 | ISSUE No.<br>01 | REV. No.<br>00 | REV. DATE:<br>21.07.2010 |
|---------------------------|-----------------------------------|-----------------|----------------|--------------------------|



|   |   |                       |                         |
|---|---|-----------------------|-------------------------|
|  <b>Offshore Design Section<br/>Engineering Services<br/>ISO – 9001:2008</b> | <b>FUNCTIONAL<br/>SPECIFICATION FOR<br/>Welding &amp; NDT</b> | <b>Spec. No.</b>      | <b>2009F</b>            |
|   |   | <b>Rev. No.</b>       | <b>8</b>                |
|   |   | <b>Discipline</b>     | <b>QA &amp; Welding</b> |
|   |   | <b>Page: 22 OF 36</b> |                         |

Welding procedures shall be qualified in accordance with AWS D1.1 Structural Welding Code – Steel, except as modified by this specification: The essential variable list of all welding processes shall be increased to include any change in the manufacturing process for the base metal, i.e. separate procedures are required for As Rolled, Controlled Rolled, Normalized, Quench & Tempered or TMCP steel.

Welding of thin sheet shall be as per AWS D1.3 – Structural Welding Code – Sheet Steel.

Unless otherwise specified, all welds shall be full penetration multi-pass welds.

Draft / Proposed WPS shall be agreed with the Company prior to the commencement of procedure qualification.

*The applicable WPQT (Welding Procedure Qualification Testing) was done in last 2 years for ONGC Job dated with effect from date of starting fabrication. If it is not of ONGC project, it shall be fresh WPQT for project specific.”*

Such previously qualified welding procedures may be considered for Structural Welding where they comply with the present document and are appropriate to the scope of work. These WPSs should have been qualified by the same Contractor in the presence of reputed TPI agencies. New, project specific WPS shall be prepared using the old WPQTs as explained above of earlier qualified WPSs as supporting documents. In this exercise, good engineering practice & AWS D1.1 guidelines shall be followed and using PQRs in an arbitrary manner to support a new WPS will not be acceptable.

In addition to the testing requirements specified in AWS D1.1 following tests as applicable shall also be carried out during WPS qualification.

Welding procedure qualification shall include a hardness traverse of the HAZ, Weld Metal and base metal.

1. Hardness testing shall be performed along the transverse shown in Fig. 1.
2. The required hardness survey shall be tested on a suitable macro section machined from the same welded test assembly made to determine other weld joint properties.
3. The hardness surveys shall be prepared and tested in accordance with ASTM E 384, Standard Test Method for Knoop and Vickers Hardness (Hv) of Materials, using an applied load of 10 kgf.
4. Indentations shall be made along all of the transverses shown for each type of weld tested, approximately 1 mm below the surface of the base metal. In the weld metal, a minimum of three equally spaced indentations along the traverse shall be made. In the heat-affected zone, the indentations shall start as close to the fusion line as practicable. A minimum of three readings shall be taken at

|                           |                                   |                 |                |                          |
|---------------------------|-----------------------------------|-----------------|----------------|--------------------------|
| FORMAT No.<br>ODS/SOF/004 | Ref. PROCEDURE No.<br>ODS/SOP/023 | ISSUE No.<br>01 | REV. No.<br>00 | REV. DATE:<br>21.07.2010 |
|---------------------------|-----------------------------------|-----------------|----------------|--------------------------|



each weld toe. One additional reading shall be taken at least 20 mm from the fusion line at each traverse to represent unaffected base metal.

- The maximum hardness value obtained from any indentation shall not exceed 350 Hv. If any single value exceeds 350 Hv and a retest adjacent to the failed test also produces one or more values exceeding 350 Hv, the procedure qualification test has failed these requirements and a new test weld shall be made with some planned modifications of essential variables or techniques (change heat input, increase preheat, later bead sequence, etc.) and retest.
- A photomicrograph of the hardness test section shall be included in the PQR clearly showing the hardness impressions.

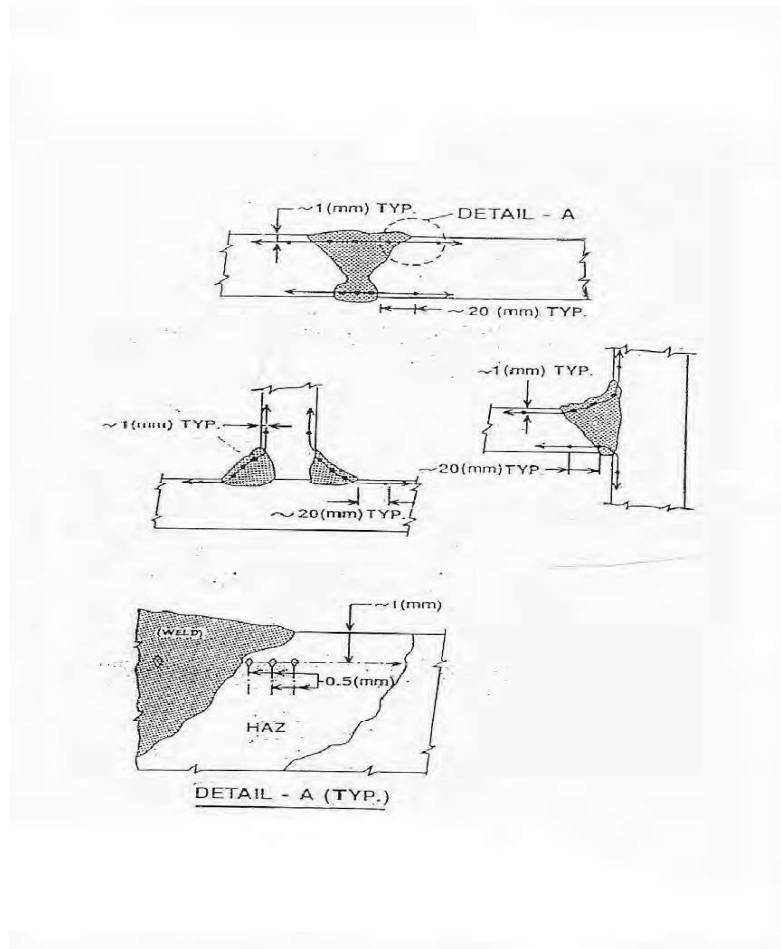



All groove welding procedure qualifications for Class A and Class B steels shall include Charpy V-notch impact testing of the deposited weld metal and the heat affected zone (HAZ). Locations for the weld and HAZ specimens shall be generally as shown in AWS D1.1, except that three sets of HAZ specimens shall be located at: (1) the fusion line (FL) (2); a position 2.0 mm into the HAZ from the fusion line (FL+2mm); and (3) a position 5.0 mm into the HAZ from the fusion line (FL+5mm) . An additional set of specimens shall also be taken from the location centred within the root pass of the weld. For acceptance the average impact energy shall meet the minimum requirement of the relevant Specification with no single value more than 6.5J lower than the average requirement. When different classes of material are to be joined the required energy level is equal to that of the lower class joined. Testing temperature shall be -10°C.

CTOD testing may be used to justify an increase in the maximum thickness of material that can be welded without the application of PWHT as defined elsewhere in this Spec.

CTOD testing shall be carried out as per BS 7448/ISO15653. Each set of CTOD tests shall comprise a minimum of three valid specimens.

CTOD testing is required on full penetration test welds representing the maximum thickness of materials that are to be welded by any single process or combination of processes.

Separate tests are required to qualify single and double sided preparation.

The steel selected for performance of the test programme shall have minimum Carbon Equivalent not less than 0.02 of the maximum CE value to be used on the project. All test plates shall be welded using heat inputs representative of the highest to be used during production welding.

For each test the least values of  $\delta_c$ ,  $\delta_u$  or  $\delta_m$  shall be greater than or equal to 0.20mm when tested at 0°C unless specified otherwise in the relevant drawings.

Charpy qualification of weld deposit and HAZ is valid only for welding procedures with heat inputs maintained within  $\pm 25\%$  of the tested weld. This may require more stringent tolerance on travel, speed, voltage and amperage.

|   |   |   |                                |
|---|---|---|--------------------------------|
|  | <b>Offshore Design Section<br/>Engineering Services<br/>ISO – 9001:2008</b> | <b>FUNCTIONAL<br/>SPECIFICATION FOR<br/>Welding &amp; NDT</b> | <b>Spec. No.</b> 2009F         |
|   |   |   | <b>Rev. No.</b> 8              |
|   |   |   | <b>Discipline</b> QA & Welding |
|   |   |   | <b>Page:</b> 25 OF 36          |

In similar fashion the inter pass temperature is limited to that actually achieved and sustained during the procedure test.

Welders shall be qualified as per AWS D1.1 Structural Welding Code – Steel. All welder qualification must have been performed on the entire weld thickness. ‘Tack Welders’ or ‘Fillet Welders’ partial qualification is not allowed. Qualification on production welds shall not be allowed.

1. \_\_\_\_\_ can provide improved root beads on single sides welds. Their use, however is prohibited as they may cause fatigue crack initiation.
2. Unless otherwise specified, all welds shall be \_\_\_\_\_ Full Penetration Welds shall be used for built-up-girders.
3. \_\_\_\_\_
4. Welding shall proceed in a manner that \_\_\_\_\_  
The Contractor shall be responsible for preventing or correcting distortions. If excessive distortion becomes evident, corrective methods shall be applied as agreed with the Company Representative.
5. Welds shall \_\_\_\_\_
6. \_\_\_\_\_
7. \_\_\_\_\_  
Welding pre-heat shall be as specified in the Qualified Welding Procedure, but shall not be less than as specified in AWS D1.1 (Table 3.2). The guidelines given in Appendix XI of AWS D1.1 shall also be taken into account and adopted as appropriate.  
If any metal is damp or less than 10<sup>0</sup>C, a minimum preheat of 38<sup>0</sup>C shall be required regardless of thickness.

|   |   |   |                       |                         |
|---|---|---|-----------------------|-------------------------|
|  | <b>Offshore Design Section<br/>Engineering Services<br/>ISO – 9001:2008</b> | <b>FUNCTIONAL<br/>SPECIFICATION FOR<br/>Welding &amp; NDT</b> | <b>Spec. No.</b>      | <b>2009F</b>            |
|   |   |   | <b>Rev. No.</b>       | <b>8</b>                |
|   |   |   | <b>Discipline</b>     | <b>QA &amp; Welding</b> |
|   |   |   | <b>Page: 26 OF 36</b> |                         |

Preheating shall be carried out by using Oxy-fuel bulbous type torches, induction or electric resistance heating. Oxy-Acetylene cutting torches shall under no circumstances be used for preheat application.

8.

The temperature of previously deposited weld metal and surrounding base metal within 75 mm of each side of the weld and throughout the wall thickness shall meet the following requirements prior to depositing subsequent beads

Minimum – Not less than the specified pre heat.

Maximum - 200°C or the maximum sustained and documented during procedure qualification, not to exceed 260°C.

9.

Arc strikes shall be ground out and repaired. After repair, MPI shall be carried out. Temporary attachments shall be removed by grinding or by using Oxy – Acetylene torch to 3 mm above permanent material surface, removal of the remaining 3mm shall be by grinding, followed by MPI / DPI. Company may require an ultrasonic check to establish that the remaining wall thickness is not less than the design minimum. Arc air gouging, hammering or other mechanical means shall not be used for the removal of temporary attachments.

10.

PWHT shall be required in the following circumstances or when shown on the design drawings:

a) When fabricating tubulars with d/t ratios less than 20.

b) For nodal joints where the minimum throat thickness exceeds 40mm. c)

For other areas where the minimum throat thickness exceeds 50mm.

*PWHT shall be carried out for all above three cases individually for Onshore-Yard fabrication in compliance to ST 3.5-point no.11. PWHT shall be carried out for all type of non-TMCP steel. For any special steel as specified by steel manufacturer and approved by ONGC for obviating PWHT with CTOD may be considered.*

*However PWHT is waved off for welding during installation phase at offshore and CTOD shall be carried out with qualified PQR (fresh) per every new project & subsequent WPS (fresh) is required for structural welding. In this case (offshore) the Fracture Mechanics Assessment ( FMA ) , its ( FMA) separate report, Crack Tip Opening Displacement (CTOD) method and its ( CTOD) test report , as per BS 7448/ISO15653 shall be used to obviate the requirement for PWHT (as for all applicable cases separately for b & c only).*

may be used to obviate the requirement for PWHT (as per b c), if approval in writing is given by the Company. In this case CTOD test shall be carried out during the WPS qualification.

***This entire clause of ST .3.5.10 shall also be applicable for welding jobs with piping.***

|                           |                                   |                 |                |                          |
|---------------------------|-----------------------------------|-----------------|----------------|--------------------------|
| FORMAT No.<br>ODS/SOF/004 | Ref. PROCEDURE No.<br>ODS/SOP/023 | ISSUE No.<br>01 | REV. No.<br>00 | REV. DATE:<br>21.07.2010 |
|---------------------------|-----------------------------------|-----------------|----------------|--------------------------|



11.

All PWHT shall be performed in accordance with AWS D1.1 and the applicable welding procedure qualification.

- a) The CONTRACTOR shall inform the COMPANY prior to any PWHT operation.
- b) No welding shall be performed on fabrications subsequent to PWHT.
- c) PWHT requirements shall be stipulated on the relevant WPS and shall comply with AWS D1.1, Section 5.8. The temperature for PWHT shall be  $600^{\circ}\text{C} \pm 20^{\circ}\text{C}$  unless recommended otherwise by the steel manufacturer.
- d) For all welds requiring PWHT, the specified inspection and NDT shall be performed after completion of PWHT process but not before the welds have cooled to ambient temperature. NDT prior to PWHT, performed in addition to mandatory NDT following PWHT, shall be at the discretion of the Contractor. However, where defects requiring repair are located by this inspection, it shall be brought to the notice of Company.
- e) The contractor shall submit a heat treatment procedure for approval by the Company. This procedure shall define heat and cooling rate, holding time at temperature and details of temperature measurement and control methods.
- f) PWHT temperature/time charts shall be clearly identified and retained for inclusion in the project records.

12.

Weld through primers to be used during fabrication are subject to the approval by the Company and shall be included in the weld procedure qualification. During Weld Procedure Qualification, the thickness of weld through primer shall be measured. Any increase in thickness of primer in production shall necessitate re-qualification of the affected WPS.

NDT Techniques which are to be used for inspection are Visual Inspection, RT, UT and LPT / MPI.

Contractor shall prepare detailed written NDT Procedures and shall submit the same for Company's review and approval.

| Structural   | Technique             | Specification                                   |
|--|-----------------------|---|
| Structural General                                     | RT, MPI & LPT         | ASME Sec.V & AWS D1.1                           |
| Butt & T, K, Y Joints                                  | UT                    | API RP 2X                                       |
| UT of Tubular –<br>(Factory Manufactured)<br>Long Seam | UT                    | ASTM E-273 or ASTM E-164 and AWS D1.1           |
| Butt Joints  | Advanced UT<br>System | ASME Sec. V, AWS D1.1 and applicable Code Cases |

|   |   |   |                       |                         |
|---|---|---|-----------------------|-------------------------|
|  | <b>Offshore Design Section<br/>Engineering Services<br/>ISO – 9001:2008</b> | <b>FUNCTIONAL<br/>SPECIFICATION FOR<br/>Welding &amp; NDT</b> | <b>Spec. No.</b>      | <b>2009F</b>            |
|   |   |   | <b>Rev. No.</b>       | <b>8</b>                |
|   |   |   | <b>Discipline</b>     | <b>QA &amp; Welding</b> |
|   |   |   | <b>Page: 28 OF 36</b> |                         |

NDT Procedures including equipments shall be qualified as per the requirements of AWD D1.1, API RP 2X and ASME Sec. V as applicable in the presence of Company representative.

NDT coverage shall be as per API RP 2A with the following modifications.

Radiographic Examination shall be performed for the following welds

1. 10 % RT of Longitudinal Weld Seams (L)
2. 100 % RT of all girth welds in tubular - Circumferential Weld Seams ( C)
3. 100 % RT of Intersection of long seams (L) and Circumferential Seams ( C)

Inspection requirement for mill fabricated structural tubular, who are authorized to put API monogram, shall be as per the applicable code (like API 2B).

1. 100 % UT & MPI of Major brace to chord welding.
  2. 100% UT & MPI of Major brace to brace welding.
  3. Before fit-up, UT Lamination check shall be carried out on the area of the chord where bracing will be welded to ensure that the area is free from laminations.
- 
1. 10% UT & MPI of Conductor Guide Bracing
  2. 10% UT & MPI of secondary bracing and subassemblies, i.e., splash zone and / or mudline secondary bracing, boat landing etc.
  3. 100% UT & MPI of attachment weld connecting secondary bracing / sub assemblies to main members
- 
1. 100 % RT of all primary full penetration welds like splices in main skid beams, main truss beams and deck beams.
  2. 10 % RT of all secondary full penetration welds including secondary deck beams.
  3. 100 % Visual & MPI of all partial penetration welds including fillet welds.

|                           |                                   |                 |                |                          |
|---------------------------|-----------------------------------|-----------------|----------------|--------------------------|
| FORMAT No.<br>ODS/SOF/004 | Ref. PROCEDURE No.<br>ODS/SOP/023 | ISSUE No.<br>01 | REV. No.<br>00 | REV. DATE:<br>21.07.2010 |
|---------------------------|-----------------------------------|-----------------|----------------|--------------------------|





Chevron / Transverse crack check using UT is required for primary steel with thickness > 25 mm welded using SAW process. Scanning shall be carried out along the weld cap.

100% UT and / MPI shall be carried out on all welds in built-up girders.

Notes:

1. Partial inspection should be conducted as 10 percent of each piece, not 100 percent of 10 percent of the number of pieces. Partial inspection should include a minimum of three segments randomly selected unless specific problems are known or suspected to exist. All suspect areas (e.g., areas of tack welds) shall be included in the areas to be inspected. If rejectable flaws are found from such 10% inspection, additional inspection should be performed until the extent of rejects has been determined and the cause corrected.
2. Welds, which cannot be radiographed because of their location, geometry, inaccessibility, excessive & impractical radiographic exposure time required or due to safety reasons, can be examined by ultrasonic and / or liquid penetrant / magnetic particle method as applicable with permission from Company. The extent of inspection shall be the same as for radiography

| Technique                                 | Acceptance Criteria |
|---|---------------------|
| RT  | AWS D1.1            |
| UT – Butt & TKY Joints                    | API RP 2X Level C   |
| UT – Long Seam of Mill Fabricated Tubular | API RP 2X Level A   |

NDT Operator Qualification & experience records shall be submitted for Company’s review. NDT Operators shall be minimum Level II qualified, PCN qualification is preferred. NDT Operators doing examination of TKY joints should have previous verifiable experience in similar job. Skill levels of NDT Operators will be further examined through practical mock tests & written examination. Contractor shall make necessary arrangements for the same with no additional cost to Company.

**Phased Array UT (PAUT)/TOFD** shall be used where the thickness is beyond 19 mm, for which permission is not required from Company. However *The PAUT/TOFD used shall satisfy the following conditions which has to be established by the NDT agency during the “Project specific procedure qualification” to be witnessed by ONGC/CA/TPI for the 1<sup>st</sup> time during start of NDT techniques.*

The \_\_\_\_\_ will be used subject to satisfying the following conditions:

1. Past track record of the agency performing PAUT / TOFD shall be submitted for Company’s review and approval.



|   |   |   |                       |                         |
|---|---|---|-----------------------|-------------------------|
|  | <b>Offshore Design Section<br/>Engineering Services<br/>ISO – 9001:2008</b> | <b>FUNCTIONAL<br/>SPECIFICATION FOR<br/>Welding &amp; NDT</b> | <b>Spec. No.</b>      | <b>2009F</b>            |
|   |   |   | <b>Rev. No.</b>       | <b>8</b>                |
|   |   |   | <b>Discipline</b>     | <b>QA &amp; Welding</b> |
|   |   |   | <b>Page: 30 OF 36</b> |                         |

2. Written UT Procedure shall be prepared as per the applicable code and shall be submitted for Company's review and approval.
3. PAUT / TOFD Procedure shall be demonstrated and qualified as per the Code requirements and to the satisfaction of the Company in the presence of Company Representative. During the demonstration, it shall be established that the scanning technique employed covers the entire weld volume and HAZ.
4. NDT Operator Qualification records (minimum level II) including experience in PAUT / TOFD shall be submitted for Company's review and approval.
5. Skill levels of NDT Operators will be further examined through practical mock tests and written tests. Contractor shall make the necessary arrangements for the same with no additional cost to Company.
6. Familiarisation & interpretation Training on PAUT / TOFD shall be provided to Company's inspectors as and when required with no cost to ONGC.
7. For any ambiguous indication observed in PAUT / TOFD, especially in the case of volumetric discontinuities, if ONGC desires, RT of that joint shall be carried out without any additional cost to ONGC.
8. Soft copy of scan data (A-Scan, C-Scan, Sector Scan etc.) of each joint along with the software for viewing the same shall be submitted to ONGC.

NDT of primary structural welded members should generally be carried out 24 hrs after completion of welding.

All low fatigue joints shall be inspected for acceptance to required profile and toe grinding shall be performed, if required.

Disk test shall be performed as mentioned in AWS D1.1.

Repair welding shall be performed strictly in accordance with the qualified repair welding procedure.

Removal of Defects

|   |   |   |                       |                         |
|---|---|---|-----------------------|-------------------------|
|  | <b>Offshore Design Section<br/>Engineering Services<br/>ISO – 9001:2008</b> | <b>FUNCTIONAL<br/>SPECIFICATION FOR<br/>Welding &amp; NDT</b> | <b>Spec. No.</b>      | <b>2009F</b>            |
|   |   |   | <b>Rev. No.</b>       | <b>8</b>                |
|   |   |   | <b>Discipline</b>     | <b>QA &amp; Welding</b> |
|   |   |   | <b>Page: 31 OF 36</b> |                         |

Removal of defects for repair may be by any of the following methods: machining, grinding, chipping, or air carbon arc gouging. The method shall produce a clean uncontaminated surface for installation of the repair weld.

Gouging

Oxygen gouging shall not be used in quenched and tempered, normalized or TMCP steels. All gouges shall be ground, power wire brushed, or grit blasted to remove all traces of residual carbon and oxidation.

After gouging to remove the defects, the area shall be ground smooth and shall be examined with LPT to ensure that the entire defect has been removed.

Completed repairs shall be examined by the same NDT methods used for the original weld

Only two times repairs are allowed on any joint.

|                           |                                   |                 |                |                          |
|---------------------------|-----------------------------------|-----------------|----------------|--------------------------|
| FORMAT No.<br>ODS/SOF/004 | Ref. PROCEDURE No.<br>ODS/SOP/023 | ISSUE No.<br>01 | REV. No.<br>00 | REV. DATE:<br>21.07.2010 |
|---------------------------|-----------------------------------|-----------------|----------------|--------------------------|



The following Codes shall be the minimum acceptable standards for subsea pipeline welding and inspection. The latest edition, addenda, code cases and supplement available at the time of bidding will be used. Any part of any other non-listed code referred to in these listed codes as augmentation is to be considered applicable.

|                      |  |
|----------------------|--|
| DNV OS F101          | Submarine Pipeline System  |
| BS 7910              | Guide to methods for assessing the acceptability of flaws in metallic structures   |
| ASTM E1961           | Standard Practice for Mechanized Ultrasonic Testing of Girth Welds Using Zonal Discrimination with Focused Search Units                                      |
| AWS A2.4             | Standard Symbols for Welding, Brazing and Nondestructive Examination.  |
|                      |  |
| NACE MR0175          | Standard Material Requirements - Metals for Sulfide Stress Cracking and Stress Corrosion Cracking Resistance in Sour Oilfield Environments                   |
| NACE TM0284          | Standard Test Method - Evaluation of Pipeline and Pressure Vessel Steels for Resistance to Hydrogen-Induced Cracking   |
| NACE TM0177          | Standard Test Method - Laboratory Testing of Metals for Resistance to Sulfide Stress Cracking and Stress Corrosion Cracking in H <sub>2</sub> S Environments |
| ASME BPVC Sec. V     | Nondestructive Examination   |
| ASME Sec. II, Part C | Specification for Welding Rods, Electrodes and Filler Metals   |
| ASTM E164            | Standard Practice for Contact Ultrasonic Testing of Weldments  |
| ASTM E165            | Practice for Liquid Penetrant Inspection Methods   |
| ASTM E709            | Practice for Magnetic Particle Examination   |
| ASTM E94             | Standard Guide for Radiographic Examination  |
| ASTM E384            | Standard Test Method for Knoop and Vickers Hardness of Materials   |
| ISO 14731            | Welding Coordination – Tasks and Responsibilities  |
| ASNT SNT-TC-1A       | Personnel Qualification and Certification in Nondestructive Testing  |
|                      |  |

Various welding processes as given in DNV-OS-F101 can be used for production welding. If the contractor propose to use mechanized welding process, a complete description of the process including examples of previously qualified welding procedures and subsea pipeline

|   |   |   |                       |                         |
|---|---|---|-----------------------|-------------------------|
|  | <b>Offshore Design Section<br/>Engineering Services<br/>ISO – 9001:2008</b> | <b>FUNCTIONAL<br/>SPECIFICATION FOR<br/>Welding &amp; NDT</b> | <b>Spec. No.</b>      | <b>2009F</b>            |
|   |   |   | <b>Rev. No.</b>       | <b>8</b>                |
|   |   |   | <b>Discipline</b>     | <b>QA &amp; Welding</b> |
|   |   |   | <b>Page: 33 OF 36</b> |                         |

projects completed using proposed process shall be submitted for Company's review and approval. Mechanised and Automatic welding systems shall be subject to a detailed pre-qualification programme or documentation before they may be used. The extent and the contents of a pre-qualification programme for such mechanised welding systems shall be agreed before start up. The Contractor shall prove and document that the welding systems are reliable and that the process can be continuously monitored and controlled.

Welding consumables and welding processes shall give a diffusible hydrogen content of maximum 5ml / 100g of weld metal.

Cellulose coated electrodes may be used only subject to agreement for welding of Pipeline Girth welds in CS Line pipe with SMYS  $\leq$  450 MPa. If used, the delay between completion of root pass and the deposition of hot pass shall be simulated during welding procedure qualification. If the use of cellulosic electrode has been agreed, the following additional requirements shall apply:

1. Pre-heat shall be minimum 100<sup>0</sup>C.
2. Delay between the completion of root pass and the start of depositing the hot pass shall be minimum 6 minutes.
3. Immediately upon completion of welding during welding procedure qualification, the test pieces shall be water quenched as soon as the temperature of the test piece is below 300<sup>0</sup>C.
4. Non destructive testing of the test pieces shall be by Automated Ultrasonic Testing (AUT) or by Radiographic Testing and Manual Ultrasonic Testing.

Low Hydrogen Electrodes with uphill techniques shall be used for all repairs, when external lineup clamp is used, tie-in, special crossings and f

Welding Procedure shall be qualified as per DNV-OS-F101(Submarine Pipeline Systems) except as modified by this specification. Previously qualified welding procedures are not acceptable. However, for welding of CS & CS NACE Line Pipes (Girth welds) of SMYS < 450 MPa, WPS for new production job may be based on a previously qualified WPQR (Welding Procedure Qualification Record) provided

- a. The applicable WPQT (Welding Procedure Qualification Testing) was done in last 2 years for ONGC Job dated with effect from date of starting fabrication. If it is not of ONGC project, it shall be fresh WPQT for project specific.
- b. WPQT was witnessed by a reputed TPI agency.
- c. Meet all the requirements of this specification and DNV-OS-F101.
- d. Match all the essential parameters as given in DNV-OS-F101.
- e. Written approval shall be obtained from Company.

For new WPS, the contractor shall first submit the Preliminary WPS (pWPS) for Company's review and approval. The pWPS shall contain all the relevant information required for the applicable welding process, as given in Clause D700 of DNV-OS-F101. After getting the approval of pWPS, the contractor can go ahead with the WPS qualification as per the requirements given in

|                           |                                   |                 |                |                          |
|---------------------------|-----------------------------------|-----------------|----------------|--------------------------|
| FORMAT No.<br>ODS/SOF/004 | Ref. PROCEDURE No.<br>ODS/SOP/023 | ISSUE No.<br>01 | REV. No.<br>00 | REV. DATE:<br>21.07.2010 |
|---------------------------|-----------------------------------|-----------------|----------------|--------------------------|

|   |   |   |                       |                         |
|---|---|---|-----------------------|-------------------------|
|  | <b>Offshore Design Section<br/>Engineering Services<br/>ISO – 9001:2008</b> | <b>FUNCTIONAL<br/>SPECIFICATION FOR<br/>Welding &amp; NDT</b> | <b>Spec. No.</b>      | <b>2009F</b>            |
|   |   |   | <b>Rev. No.</b>       | <b>8</b>                |
|   |   |   | <b>Discipline</b>     | <b>QA &amp; Welding</b> |
|   |   |   | <b>Page: 34 OF 36</b> |                         |

DNV-OS-F101. Qualification welding shall be performed using the type of welding equipment to be used for production welding and under conditions that are representative of the actual working environment for the work (for WPSs to be used on pipelay barges, qualification welding has to be carried out on floating vessels / barges).

WPS qualification shall be witnessed by Company Representative and a reputed TPI agency.

Repair welding procedure shall be qualified separately. Pre-heat for repair welding shall be minimum 50°C above the minimum specified pre-heat for production welding. Re-repair welding procedure shall also be qualified separately.

*In case of riser line, as it is considered part of pipeline, this WPQT & WPS is applicable till the flange joint of shutdown valve or launcher whichever is earlier. In case, this riser line is prefabricated in yard, the same WPQT & WPS is applicable. However internal/external line clamp may not be required as mentioned in clause PL4.6*

Welders and Welding Operators shall be qualified as per the requirements of DNV-OS-F101 in the presence of Company Representative and a reputed TPI agency. Welders shall be qualified under conditions that are representative of the actual working environment. (Pipeline welders shall be qualified on floating vessel / barge)

The type of welding Equipment and Welding Procedure shall be qualified prior to the start of installation welding.

Internal line-up clamp shall be used for pipeline of size 6” and above. Internal lineup clamp shall remain in place at least until the root pass is completed around the full circumference.

External lineup clamp shall not be removed until a minimum of 50% of root pass, uniformly spaced around the circumference, has been completed.

Arc strikes – arc shall be struck only on fusion faces and not on other areas of the pipe.

The pipelay barge shall not be moved before the first hot pass is completed.

The extent of NDT for installation girth welds shall be 100% Automated Ultrasonic Testing (AUT) or Radiographic Testing. Radiography shall be carried out using X-ray with panoramic exposure. Gama ray may be used in case of inaccessible joints with approval of ONGC ( with submission of specific joint details & with AFC).

For wall thickness > 25 mm, AUT should be used. For >25mm, if RT is used, it shall be supplemented with Ultrasonic Testing.

While using GMAW (like mechained or semi-automatic welding) or FCAW welding process, AUT is the preferred NDT technique.

|                           |                                   |                 |                |                          |
|---------------------------|-----------------------------------|-----------------|----------------|--------------------------|
| FORMAT No.<br>ODS/SOF/004 | Ref. PROCEDURE No.<br>ODS/SOP/023 | ISSUE No.<br>01 | REV. No.<br>00 | REV. DATE:<br>21.07.2010 |
|---------------------------|-----------------------------------|-----------------|----------------|--------------------------|

|   |   |   |                       |                         |
|---|---|---|-----------------------|-------------------------|
|  | <b>Offshore Design Section<br/>Engineering Services<br/>ISO – 9001:2008</b> | <b>FUNCTIONAL<br/>SPECIFICATION FOR<br/>Welding &amp; NDT</b> | <b>Spec. No.</b>      | <b>2009F</b>            |
|   |   |   | <b>Rev. No.</b>       | <b>8</b>                |
|   |   |   | <b>Discipline</b>     | <b>QA &amp; Welding</b> |
|   |   |   | <b>Page: 35 OF 36</b> |                         |

100% Ultrasonic Testing of first 10 welds shall be carried out while using GMAW or FCAW processes, when starting installation or when resuming production after suspension of welding and when radiographic testing is the primary NDT technique. If Ultrasonic Testing reveals defects not discovered by radiography, the extent of Ultrasonic Testing shall be 100% for the next 10 welds. If the results of this extended testing are unsatisfactory, the welding shall be suspended until the causes of the defects have been established and rectified.

UT lamination check shall be carried out on 50 mm wide band at the flame cut pipe ends.

For "Golden Welds" (critical welds e.g. tie-in welds that will not be subject to pressure testing, etc.) 100% ultrasonic testing, 100% radiographic testing, and 100% magnetic particle testing or 100% liquid penetrant testing of non-ferromagnetic materials shall be performed. If the ultrasonic testing is performed as automated ultrasonic testing, the radiographic and magnetic particle/liquid penetrant testing may be omitted subject to agreement.

Prior to commencement of WPS qualification, contractor shall prepare and submit NDT Procedures (RT, MPI, LPT, UT/AUT) for Company's review and approval.

NDT Procedures, Equipment qualification and Acceptance Criteria shall be as per the requirements given in Appendix D of DNV-OS-F101.

AUT Procedures, Equipment and qualification for AUT shall be as per the requirements given in Appendix E of DNV-OS-F101. Defect Acceptance Criteria shall be arrived at using ECA. AUT

shall be performed in accordance with DNV-OS-F101 Appendix E and ASTM E1961.

If the Contractor proposes to use AUT, the contractor shall arrange familiarization and interpretation training on AUT for Company inspectors as and when required without any additional cost to Company

If using AUT, Contractor shall carry out ECA to arrive at weld acceptability criteria which is subject to approval by Company. As a minimum, requirements of Appendix A of DNV-OS-F101 shall be met. Details of laboratory / agency performing ECA shall be submitted to Company for review and acceptance. The agency should have skilled personnel and previous experience to carry out ECA as per BS 7910 requirements.

The effectiveness of the AUT Procedure shall be demonstrated by a qualification programme in accordance with DNV-OS-F-101, Appendix E, Section H. The AUT system must demonstrate the ability to detect and accurately size length and vertical height of indications with a resolution compatible with the applicable acceptance criteria.

NDT Operators shall be qualified and certified in accordance with the requirements of Level II of the latest edition of SNT-TC-1A or equivalent PCN or CSWIP Level II.

|                           |                                   |                 |                |                          |
|---------------------------|-----------------------------------|-----------------|----------------|--------------------------|
| FORMAT No.<br>ODS/SOF/004 | Ref. PROCEDURE No.<br>ODS/SOP/023 | ISSUE No.<br>01 | REV. No.<br>00 | REV. DATE:<br>21.07.2010 |
|---------------------------|-----------------------------------|-----------------|----------------|--------------------------|

|   |   |   |                       |                         |
|---|---|---|-----------------------|-------------------------|
|  | <b>Offshore Design Section<br/>Engineering Services<br/>ISO – 9001:2008</b> | <b>FUNCTIONAL<br/>SPECIFICATION FOR<br/>Welding &amp; NDT</b> | <b>Spec. No.</b>      | <b>2009F</b>            |
|   |   |   | <b>Rev. No.</b>       | <b>8</b>                |
|   |   |   | <b>Discipline</b>     | <b>QA &amp; Welding</b> |
|   |   |   | <b>Page: 36 OF 36</b> |                         |

Additionally, AUT operators shall have received a sufficient level of training of Automated Ultrasonic Testing, including practical and theoretical aspects applicable to the equipment and configuration to be examined. This training shall be documented and will be verified by the Company.

Repair welding shall be performed in accordance with a qualified repair welding procedure. After grinding / gouging, Magnetic particle testing or liquid penetrant testing of non-ferromagnetic materials shall be performed to verify complete removal of defects before commencing weld repairs.

Pre-heat for repair welding shall be 50<sup>0</sup>C more than that used for production welding.

Only two times repairs are allowed on any joint.

If the repair welding station is after the pipe tensioner, a weld repair analysis shall be carried out.

The analysis shall determine the maximum allowable excavation length and depth combinations taking in to account all stresses acting at the area of the repair. The weld repair analysis shall be subject to agreement.

For materials other than CS & CS NACE, contractor shall prepare various procedures like WPS, NDT etc. and shall submit for Company's review and approval.

-----

|   |   |   |              |                  |
|---|---|---|--------------|------------------|
|  | <b>Offshore Design Section<br/>Engineering Services<br/>ISO – 9001:2008</b> | <b>FUNCTIONAL<br/>SPECIFICATION FOR<br/>Welding of Duplex Stainless<br/>Steel</b> | Spec. No.    | 2009F<br>Annex.1 |
|   |   |   | Rev. No.     | 1                |
|   |   |   | Discipline   | QA & Welding     |
|   |   |   | Page: 1 OF 7 |                  |

## ANNEXURE I

# WELDING OF DUPLEX STAINLESS STEEL

|                          |             |             |                       |            |          |
|--------------------------|-------------|-------------|-----------------------|------------|----------|
|                          |             |             | 7                     | 10/01/2005 | 1        |
| PDD / PNN                | SKS / MP    | JSS         |                       |            |          |
| PREPARED /<br>REVISED BY | REVIEWED BY | APPROVED BY | TOTAL No. OF<br>PAGES | DATE       | REV. No. |

|                           |                                   |                 |                |                          |
|---------------------------|-----------------------------------|-----------------|----------------|--------------------------|
| FORMAT No.<br>ODS/SOF/004 | Ref. PROCEDURE No.<br>ODS/SOP/023 | ISSUE No.<br>01 | REV. No.<br>00 | REV. DATE:<br>21.07.2010 |
|---------------------------|-----------------------------------|-----------------|----------------|--------------------------|



|   |   |   |              |                  |
|---|---|---|--------------|------------------|
|  | <b>Offshore Design Section<br/>Engineering Services<br/>ISO – 9001:2008</b> | <b>FUNCTIONAL<br/>SPECIFICATION FOR<br/>Welding of Duplex Stainless<br/>Steel</b> | Spec. No.    | 2009F<br>Annex.1 |
|   |   |   | Rev. No.     | 1                |
|   |   |   | Discipline   | QA & Welding     |
|   |   |   | Page: 2 OF 7 |                  |

## WELDING SPECIFICATION FOR DUPLEX STAINLESS STEELS

### 1.0 WELDING PROCESS

Shielded Metal Arc Welding (SHAW), Gas Tungsten Arc Welding (GTAW), Submerged Arc Welding (SAW) and Plasma Arc Welding (PAW) processes are suitable for Duplex stainless steel. These Welding methods along with the related operational precautions such as cleanliness and protective gas shielding should be used for making duplex stainless steel welds. Shielding / purging gases shall be selected ensuring freedom from hydrogen.

### 2.0 MICROSTRUCTURE

The ferrite content of the weld metal estimated through metallographic examination, should be between 30% to 55% to obtain weld joints with the best ductility and corrosion resistance. The filler metal composition and the welding heat input should be so selected as to give the ferrite content of the weld metal between 30% to 55%.

### 3.0 FILLER METALS (Welding Consumables)

Table 1 enclosed herewith tentatively lists the different filler metals used for duplex stainless steels conforming to UNS S 31803. Welding consumables shall be used only after conducting consumable qualification tests. Consumables shall be degreased or baked and stored in accordance with the manufacturer's recommendations.

### 4.0 MECHANICAL PROPERTY REQUIREMENTS

The weld metal should have the following mechanical properties :

|     |                                       |   |   |
|-----|---------------------------------------|---|---|
| 4.1 | Tensile Strength                      | - | 680 – 880 N/mm <sup>2</sup>                                     |
| 4.2 | Yield Strength<br>(0.2% Offset)       | - | 450 N/mm <sup>2</sup> (Min.)                                    |
| 4.3 | Elongation                            | - | 25% (Min.)  |
| 4.4 | Impact Energy (Charpy V-notch Valves) |   |   |
|     | At + 20°C (68°F)                      | - | 100 Joules Average (72 ft. lb)<br>75 Joules Average (54 ft. lb) |

|                           |                                   |                 |                |                          |
|---------------------------|-----------------------------------|-----------------|----------------|--------------------------|
| FORMAT No.<br>ODS/SOF/004 | Ref. PROCEDURE No.<br>ODS/SOP/023 | ISSUE No.<br>01 | REV. No.<br>00 | REV. DATE:<br>21.07.2010 |
|---------------------------|-----------------------------------|-----------------|----------------|--------------------------|

|   |   |   |                     |                          |
|---|---|---|---------------------|--------------------------|
|  | <b>Offshore Design Section<br/>Engineering Services<br/>ISO – 9001:2008</b> | <b>FUNCTIONAL<br/>SPECIFICATION FOR<br/>Welding of Duplex Stainless<br/>Steel</b> | <b>Spec. No.</b>    | <b>2009F<br/>Annex.1</b> |
|   |   |   | <b>Rev. No.</b>     | <b>1</b>                 |
|   |   |   | <b>Discipline</b>   | <b>QA &amp; Welding</b>  |
|   |   |   | <b>Page: 3 OF 7</b> |                          |

At –30°C (-22°F) - 60 Joules Average (43.2 ft. lb)  
40 Joules Average (28.8 ft. lb)

## 5.0 QUALIFICATION TESTS

### 5.1 Welding Procedure Qualification Tests

#### 5.1.1 General

Each particular welding procedure shall be specially qualified for the job; no previous test reports shall be recognized as a qualification of the work to be performed. The welding filler metal to be used shall be of a grade, which will yield a weld metal equivalent to that of the base metal. Welding consumables shall be subjected to initial qualification testing and the consumable shall require company's approval. During Procedure Qualification, the heat input for 22% Cr Duplex steels shall be limited to 0.8 – 2.5 KJ/mm. In production welding, the heat input shall not deviate from that qualified by more than +/- 10%. P numbers shall not apply to duplex stainless steels. Each alloy designation shall be separately qualified in accordance with this specification.

5.1.2 Welding consumable qualification tests and welding procedure qualification tests shall be conducted before the start of procurement by employing an approved welding procedure in presence of the Company's Representative. The welding procedure shall be prepared by the Contractor based on the information provided by the Supplier of raw materials and/or electrodes Supplier and approved by the Company. Welding procedure shall be such that it gives maximum hardness on the outer surface of pipe.

All the mills supplying the raw material/pipes etc. shall be required to pass the tests required for procedure qualification testing. Approved procedure shall be common to all the mills.

Laboratory tests shall be performed at an official Laboratory approved by the Company. Sufficient advance notice shall allow the Company to witness all or part of the tests.

#### 5.1.3 Test Samples

Tests mentioned below shall be performed on welded test pieces and shall include the parent metal, heat affected zone and the weld metal.

5.1.4 Procedure Qualification Tests shall be carried out as given below :

i) Chemical Composition and Microstructure Examination

|                           |                                   |                 |                |                          |
|---------------------------|-----------------------------------|-----------------|----------------|--------------------------|
| FORMAT No.<br>ODS/SOF/004 | Ref. PROCEDURE No.<br>ODS/SOP/023 | ISSUE No.<br>01 | REV. No.<br>00 | REV. DATE:<br>21.07.2010 |
|---------------------------|-----------------------------------|-----------------|----------------|--------------------------|

|   |   |   |                     |                          |
|---|---|---|---------------------|--------------------------|
|  | <b>Offshore Design Section<br/>Engineering Services<br/>ISO – 9001:2008</b> | <b>FUNCTIONAL<br/>SPECIFICATION FOR<br/>Welding of Duplex Stainless<br/>Steel</b> | <b>Spec. No.</b>    | <b>2009F<br/>Annex.1</b> |
|   |   |   | <b>Rev. No.</b>     | <b>1</b>                 |
|   |   |   | <b>Discipline</b>   | <b>QA &amp; Welding</b>  |
|   |   |   | <b>Page: 4 OF 7</b> |                          |

The ferrite content measurement of test pieces shall be carried out by both the following methods:

- a) Metallographic determination and
- b) Magnegage method (According to Kotecki)

The procedure of ferrite measurement and the calibration of measuring instrument shall bear the approval of the Company before being employed.

ii) Mechanical Properties

These tests shall include tensile testing, impact strength and bend test. Bend tests shall be performed in accordance with ASTM A 370 with a plunger dia equal to 4 times the thickness. No defect shall be visible on bending.

iii) Hardness Tests

Each qualification test shall include a cross sectional hardness survey.

A complete survey of the weld, heat affected zone and the base metal shall be performed according to the following procedure :

- the test method shall be as per ASTM E 18.
- the distance between indentations shall be a maximum of 1 mm.
- The results shall not exceed RC 28.

iv) Corrosion Tests

- a) Intergranular Corrosion Tests (HUEY)

The welds shall be subjected to ASTM A 162 practice C (HUEY Test). Weight loss shall not exceed 3 to 4 mils/month.

- b) Chloride Stress Corrosion Cracking Test.

This type of test shall be conducted on the material at 155° C with aeration in 45% MgCl<sub>2</sub> solution as per ASTM G 36. Stress to

|                           |                                   |                 |                |                          |
|---------------------------|-----------------------------------|-----------------|----------------|--------------------------|
| FORMAT No.<br>ODS/SOF/004 | Ref. PROCEDURE No.<br>ODS/SOP/023 | ISSUE No.<br>01 | REV. No.<br>00 | REV. DATE:<br>21.07.2010 |
|---------------------------|-----------------------------------|-----------------|----------------|--------------------------|

|   |   |   |                     |                          |
|---|---|---|---------------------|--------------------------|
|  | <b>Offshore Design Section<br/>Engineering Services<br/>ISO – 9001:2008</b> | <b>FUNCTIONAL<br/>SPECIFICATION FOR<br/>Welding of Duplex Stainless<br/>Steel</b> | <b>Spec. No.</b>    | <b>2009F<br/>Annex.1</b> |
|   |   |   | <b>Rev. No.</b>     | <b>1</b>                 |
|   |   |   | <b>Discipline</b>   | <b>QA &amp; Welding</b>  |
|   |   |   | <b>Page: 5 OF 7</b> |                          |

cause repute in 500 hours shall exceed 0.35 times the ultimate tensile strength. This test is required to be done per heat for each mill before start of procurement.

c) **SSCC Test**

Resistance of the material to SSCC shall be tested using :

- a) NACE TM 01-77 test solution (Test temp. 24 Deg. C). Minimum stress for cracking in 720 Hrs shall be 350 N/mm<sup>2</sup>.
- b) NACE TM 01-77 test solution (test temp. 90 Deg C and total pressure of H<sub>2</sub>S = 16 Bars).

Min. stress for cracking in 720 Hrs = 325 N/mm<sup>2</sup>.

v) **Radiography**

The welds shall be 100% radio graphed shall be as per ASME, Section – VIII, Division – I, UW – 51.

vi) **Dye Penetrant / MP Testing**

All fillet and groove welds other than these radio graphed shall be tested by dye penetrant testing or by magnetic particle testing method. No defect shall be accepted.

vii) **Heat Treatment (if required)**

Suitable heat treatment procedure shall be established for retaining the Duplex S.S. properties of welded joints which shall be approved by the Company before implementing.

**5.2 Welder Qualification Tests**

Welders shall be qualified at the fabrication yard / barge employing the qualified welding procedure. The test pieces of each welder shall be subjected to mechanical tests, radiographic examination, DPT/MP Test, microstructure examination and cross-sectional hardness survey with the same test procedure and acceptance criteria as mentioned in 5.1 above.

**6.0 FABRICATION**

|                           |                                   |                 |                |                          |
|---------------------------|-----------------------------------|-----------------|----------------|--------------------------|
| FORMAT No.<br>ODS/SOF/004 | Ref. PROCEDURE No.<br>ODS/SOP/023 | ISSUE No.<br>01 | REV. No.<br>00 | REV. DATE:<br>21.07.2010 |
|---------------------------|-----------------------------------|-----------------|----------------|--------------------------|

|   |   |   |                     |                          |
|---|---|---|---------------------|--------------------------|
|  | <b>Offshore Design Section<br/>Engineering Services<br/>ISO – 9001:2008</b> | <b>FUNCTIONAL<br/>SPECIFICATION FOR<br/>Welding of Duplex Stainless<br/>Steel</b> | <b>Spec. No.</b>    | <b>2009F<br/>Annex.1</b> |
|   |   |   | <b>Rev. No.</b>     | <b>1</b>                 |
|   |   |   | <b>Discipline</b>   | <b>QA &amp; Welding</b>  |
|   |   |   | <b>Page: 6 OF 7</b> |                          |

6.1 *No fabrication shall start until the Company has approved the chemistry of the materials, the results of welding procedure qualification tests and welders are qualified as per the approved procedure.*

6.2 Working practices shall be designed to minimize contamination and before welding, internal and external surfaces shall be cleaned for a distance of at least 50mm from the fusion face.

6.2 In production welding the heat input shall be monitored and the same shall not deviate from the qualified WPS by more than +/- 10%.

6.2 Production/Fabrication Tests

Shop/Site Fabrication Tests for each weld shall include :

- Non – destructive hardness tests by portable hardness tester
  - Radiography
  - DPI/MP Examination
  - Ferrite Measurement by either
    - a) Magnegage method (extended range, according to Kotecki)
- OR
- b) Forster Probe Method.

|                           |                                   |                 |                |                          |
|---------------------------|-----------------------------------|-----------------|----------------|--------------------------|
| FORMAT No.<br>ODS/SOF/004 | Ref. PROCEDURE No.<br>ODS/SOP/023 | ISSUE No.<br>01 | REV. No.<br>00 | REV. DATE:<br>21.07.2010 |
|---------------------------|-----------------------------------|-----------------|----------------|--------------------------|



**Offshore Design Section  
Engineering Services  
ISO – 9001:2008**

**FUNCTIONAL  
SPECIFICATION FOR  
Welding of Duplex Stainless  
Steel**

|                     |                          |
|---------------------|--------------------------|
| <b>Spec. No.</b>    | <b>2009F<br/>Annex.1</b> |
| <b>Rev. No.</b>     | <b>1</b>                 |
| <b>Discipline</b>   | <b>QA &amp; Welding</b>  |
| <b>Page: 7 OF 7</b> |                          |

| <b>Procedure</b>            | <b>Supplier<br/>Commercial<br/>Name</b>  | <b>Typical Chemical<br/>Composition in %</b>                                    | <b>Comments</b>   |
|-----------------------------|--|---|---|
| Plasma<br>auto or<br>Manual | Smitweld SW<br>4462 (Revised<br>Composition)   | C:0.010 Mn:1.6 Si:0.25<br>P:0.20<br>S:0.008 Cr:23.0 Ni:8.8<br>Mo:3.1<br>N:0.012 | Filler metal<br>recommended when<br>as welded   |
|                             | Thysem   | C:0.016 Mn:1.57 Si:0.17<br>Cr:22.8 Ni:9.18 N:0.04                               | Very low nitrogen<br>(traces) ferrite level<br>practically identical to<br>22-6-31.             |
|                             | Thermanit 22-<br>09  |   | Excellent results<br>when welded with<br>nitrogen in welding<br>gas.                            |
| SAW                         | Thyssen<br>Thermanit   | C:0.016 Mn:1.57 Si:0.17<br>Cr:22.8 Ni:9.18 N:0.04                               | With flux SAP CN<br>100 – as welded<br>condition gives ferrite<br>range 35-65%                  |
| SMAW                        | Thermanit 22-<br>09  | C ≤ 0.030 Cr:22.0 to 23.0   |   |
|                             | Sandvik 22-9-<br>3LR Smitweld<br>Arosta 4462<br>Philips Rs 22-9-<br>3LC Avesta<br>223 FAL-PW | Ni:9 to 10<br>Mo ≈ 3, N:0.10 to 0.15  | These electrodes even<br>with low heat input,<br>give welds with<br>specified ferrite<br>range. |

|   |  |   |              |     |
|---|--|---|--------------|-----|
|  | <b>OFFSHORE<br/>ENGINEERING<br/>SERVICES</b> | <b>LIST OF<br/>IRTs ( INSPECTION<br/>REQUIREMENT TABLE)<br/>“Part Replacement Pipeline<br/>Project”</b> | Discipline   | All |
|   |  |   | Revision No. | 0   |
|   |  |   | Page: 1 OF 1 |     |

INDEX OF IRT

| S No        | Discipline | IRT No.  | Nos. of IRT | Rev. No. | Rev. date |
|-------------|------------|--|-------------|----------|-----------|
| 1           | Electrical | ODS/ELE/IRT/13   | 1           | 1        | -         |
| 2           | Pipeline   | ODS/PIPELINE/IR<br>T/01, 02, 03, 06, 08, 09, 15,<br>16, 21 & 22. | 10          | -        | -         |
| Total IRTs= |            |  | 11          |          |           |

|            |                    |           |          |            |
|------------|--------------------|-----------|----------|------------|
| FORMAT No. | Ref. PROCEDURE No. | ISSUE No. | REV. No. | REV. DATE: |
|            |                    | 03        | 00       | 26.02.2018 |

|   |   |  |                   |                   |
|---|---|--|-------------------|-------------------|
|  | <b>Offshore Design Section<br/>Engineering Services<br/>ISO – 9001:2008</b> | <b>Common Legends &amp;<br/>Notes of<br/>IRTs ( INSPECTION<br/>REQUIREMENT TABLE) &amp;<br/>APPROVAL</b> | <b>Date</b>       | <b>18/11/2016</b> |
|   |   |  | <b>Discipline</b> | <b>QA</b>         |
|   |   |  | <b>Revision</b>   | <b>1</b>          |
|   |   |  | <b>Page</b>       | <b>1 OF 4</b>     |

**Subject: Explanation of common Legends & Notes**

**1.0 Definition of Inspection categories A, B , C & BULK**

**1.1 Inspection Category : "A":**

**i) At Vendor's Place:-**

- a) ONGC/CA and Contractor/Contractor's IA shall carry out appropriate stage as well as Final Inspection as per approved ITP/QAP and issue IR/IRN.
- b) ONGC/CA shall either issue their separate IR/IRN or will endorse the IR/IRN issued by Contractor/Contractor's Inspection Agency.

**AND**

**ii) At Fabrication Yard/ Offshore Installation:-**

- a) Material received at Yard shall be verified by ONGC appointed TPI/CA with respect to Tag / Marking / Identification and IR/IRN etc.
- b) IR/IRN shall be submitted to ONGC's TPI & CA for IMIR /GIIR clearance.

**1.2 Inspection Category : "B":**

**i) At Vendor's Place :-**

- a) ONGC / CA shall carry out Final Stage Inspection at Vendor's place..
- b) Contractor/Contractor's IA shall carry out Appropriate Stage as well as Final Inspection as per approved ITP/QAP.
- c) ONGC/CA shall either issue their separate IR/IRN or will endorse the IR/IRN issued by Contractor IA.

**AND**

**ii) At Fabrication Yard/Offshore Installation :**

- a) Material received at Yard shall be verified by ONGC appointed TPI/CA with respect to Tag / Marking / Identification and IR/IRN etc.
- b) IR/IRN shall be submitted to ONGC's TPI & CA for IMIR /GIIR clearance.

**1.3 Inspection Category : "C":**

**i) At Vendor's Place :**

- a) Contractor/Contractor's IA shall carry out the Final Inspection as per the approved ITP / QAP and issue IR/IRN.

**AND**

**ii) At Fabrication Yard /Offshore Installation:**

- a) Material received at yard shall be verified by ONGC appointed TPI / CA with respect to Tag / Marking / Identification and IR/IRN etc. In case of Random Inspection, it shall be done as per guide lines of RW.
- b) IR/IRN with Backup Documents shall be submitted to ONGC's TPI & CA for IMIR /GIIR clearance.

|              |                    |           |          |            |
|--------------|--------------------|-----------|----------|------------|
| FORMAT No.   | Ref. PROCEDURE No. | ISSUE No. | REV. No. | REV. DATE: |
| ODS/SOF/047A | ODS/SOP/023        | 02        | 00       | 08.03.2016 |



|   |   |  |                   |                   |
|---|---|--|-------------------|-------------------|
|  | <b>Offshore Design Section<br/>Engineering Services<br/>ISO – 9001:2008</b> | <b>Common Legends &amp;<br/>Notes of<br/>IRTs ( INSPECTION<br/>REQUIREMENT TABLE) &amp;<br/>APPROVAL</b> | <b>Date</b>       | <b>18/11/2016</b> |
|   |   |  | <b>Discipline</b> | <b>QA</b>         |
|   |   |  | <b>Revision</b>   | <b>1</b>          |
|   |   |  | <b>Page</b>       | <b>2 OF 4</b>     |

**1.4 Inspection Category : “Bulk”:**

**i) At Vendor's Place :**

- a) Contractor /Contractor IA shall carry out Inspection / review the manufacturer test certificate and issue IR/IRN.

**AND**

**ii) At Fabrication Yard/Offshore Installation :**

- a) Material received at yard shall be verified by ONGC appointed CA & TPI with respect to Tag / Marking / Identification etc. In case of Random Inspection, it shall be done as per guide lines of RW.
- b) IR/IRN with back up documents shall be submitted to ONGC's TPI & CA for IMIR /GIIR clearance.

**2.0 Legends:**

- a) CA- Certification Agency appointed by ONGC
- b) TPI- Third Party Agency appointed by ONGC
- c) Contractor IA- Contractor's Inspection agency, appointed by the LSTK Contractor
- d) ITP / QCP/QAP - Inspection & Test Plan / Quality Control Plan/Quality Assurance Plan
- e) IRT - Inspection Requirement Table.
- f) IR/IRN - Inspection Report/ Inspection Release Note.
- g) IMIR/GIIR-Inward Material Inspection Report/Goods Inward Material Inspection.
- h) I- information.
- i) A – Approval.
- j) R – Review.
- k) Rw or RW - Random Witness Inspection
- l) W- Witness Inspection.
- m) R/W- Review & Witness Inspection.
- n) X-Submission of Supporting Documents during review at any stage.
- o) Is- Issue of documents like Inspection Release Note (IRN)/report etc.
- p) FAT - Factory Acceptance Test
- q) SAT – Site Acceptance Test

|              |                    |           |          |            |
|--------------|--------------------|-----------|----------|------------|
| FORMAT No.   | Ref. PROCEDURE No. | ISSUE No. | REV. No. | REV. DATE: |
| ODS/SOF/047A | ODS/SOP/023        | 02        | 00       | 08.03.2016 |

|   |   |  |                   |                   |
|---|---|--|-------------------|-------------------|
|  | <b>Offshore Design Section<br/>Engineering Services<br/>ISO – 9001:2008</b> | <b>Common Legends &amp;<br/>Notes of<br/>IRTs ( INSPECTION<br/>REQUIREMENT TABLE) &amp;<br/>APPROVAL</b> | <b>Date</b>       | <b>18/11/2016</b> |
|   |   |  | <b>Discipline</b> | <b>QA</b>         |
|   |   |  | <b>Revision</b>   | <b>1</b>          |
|   |   |  | <b>Page</b>       | <b>3 OF 4</b>     |

### 3.0 Explanation of terminology used in ITPs, viz. RANDOM WITNESS 'HOLD INSPECTION', WITNESS.

#### i) **Rw or RW: Random WITNESS ( Inspection)**

- a) Sampling percentage shall be specified as minimum 10% and shall do marking ( Metal/Rubber stamping ) & serial nos. or lot no. shall be logged in IR/IRN.
- b) Any non-conformances ( NC) or discrepancies observed during the inspection of 1<sup>st</sup> lot of 10%, then 2<sup>nd</sup> lot of next 20% shall be inspected, further if any NC observed then all the 100% shall be inspected.
- c) Vendor will raise notification for the timing of Inspection / Test. In case CA doesn't visit within specified time of the agreed schedule, vendor may proceed with Inspection & further work in presence of Contractor /Contractor IA. Record of inspection will be submitted to CA for review.

#### ii) **H – Hold (Inspection):**

- a) Vendor shall give 5 working days (as applicable) advance notification in case of Inspection in India and 10 working days in case of Inspection in abroad to Inspection agency (Contractor /Contractor IA and CA) as specified in approved ITP. Vendor shall ensure readiness of Internal 'QAD / Factory' Inspection reports.
- b) Vendor shall not proceed with further operation without clearance from Contractor / Contractor IA (or) waiver from the Inspection agency for whom the 'hold inspection' point is indicated i.e. Contractor / Contractor IA / Company CA as applicable. In case waiver is obtained, then IR/IRN shall be issued based on review of Inspection report of that Inspection stages.

#### iii) **W – Witness (100% inspection)**

- a) Vendor shall give 5 working days (as applicable) advance notification in case of Inspection in India and 10 working days in case of Inspection in foreign to Inspection agency (Contractor /Contractor IA and Company CA) as specified in approved ITP. Vendor shall ensure readiness of Internal 'QAD / Factory' Inspection reports/ Release note.
- b) In case Certifying agency does not visit within the specified time of the agreed schedule, vendor may proceed with the Inspection and for further operations in presence of Contractor / Contractor IA. Record of Inspection carried out by vendor and Contractor / Contractor IA shall be provided to CA for review and for obtaining the Release Note.

### 4.0 General NOTES:

- a) **Note-1:** Contractor/Contractor IA shall carry out Inspection and/or review the Documents as per approved ITP/QAP and prepare the Final Release Note. Contractor shall opt for ONGC empanelled Inspection agency as Contractor IA , but will exclude the agencies appointed by ONGC as their CA & TPI for that particular project.

|              |                    |           |          |            |
|--------------|--------------------|-----------|----------|------------|
| FORMAT No.   | Ref. PROCEDURE No. | ISSUE No. | REV. No. | REV. DATE: |
| ODS/SOF/047A | ODS/SOP/023        | 02        | 00       | 08.03.2016 |

|   |   |  |                   |                   |
|---|---|--|-------------------|-------------------|
|  | <b>Offshore Design Section<br/>Engineering Services<br/>ISO – 9001:2008</b> | <b>Common Legends &amp;<br/>Notes of<br/>IRTs ( INSPECTION<br/>REQUIREMENT TABLE) &amp;<br/>APPROVAL</b> | <b>Date</b>       | <b>18/11/2016</b> |
|   |   |  | <b>Discipline</b> | <b>QA</b>         |
|   |   |  | <b>Revision</b>   | <b>1</b>          |
|   |   |  | <b>Page</b>       | <b>4 OF 4</b>     |

- b) Note-2:** For ASME Coded vessel Fabrication, ASME AI (Authorized Inspector) will carry out Inspection as per code requirements. Contractor/Contractor IA shall carry out Inspection as per ITP/QAP.
- c) Note-3:** Random Inspection as per guide lines of RW may be carried out by CA for Inspection of Category C & Bulk items, if required as and when specified in IRT/QAP.
- d) Note 4:** At the time of inspection for category A, B or C, if any additional test required shall be carried out as per referred standard, mentioned in FS apart from IRT.
- e) Note 5:** This IRT is issued to provide extensive guidelines for preparation of ITP/QAP.
- f) Note 6:** This IRT is for the inspection by the above mentioned inspection agencies. Any class / statutory body inspection wherever required / applicable, shall be in addition to this.
- g) Note 7:** For all the bulk category items, the documentation (MTC, Test Certificate/ Report/ FAT, IRN, etc) shall be submitted by contractor to Company for review and record, prior to issue of IMIR/GIIR (Except for Bulk items pertaining to Piping Discipline)
- h) Note 8:** Material of any category shall be used by contractor only after clearance by ONGC/Certification Agency (CA) of IMIR/GIIR against complete documentation (MTC, Test Certificate/ Report/FAT, IRN, etc).

| <b>Prepared / Revised By</b> | <b>Reviewed By</b> | <b>Approved By</b> |
|------------------------------|--------------------|--------------------|
|                              |                    |                    |
| G. Jana                      | M.R. Shete         | S.C.Jain           |

|              |                    |           |          |            |
|--------------|--------------------|-----------|----------|------------|
| FORMAT No.   | Ref. PROCEDURE No. | ISSUE No. | REV. No. | REV. DATE: |
| ODS/SOF/047A | ODS/SOP/023        | 02        | 00       | 08.03.2016 |



Offshore Design Section  
Engineering Services  
ISO – 9001:2008

**LIST OF  
IRTs ( INSPECTION  
REQUIREMENT TABLE) &  
APPROVAL**

Date 06/01/2017  
Discipline ELECTRICAL  
Page: 1 OF 1

| SI No | Item   | IRT No         | Rev No | Category |
|-------|--|----------------|--------|----------|
| 1     | AC DC Distribution Board/Lighting and Power Distribution Board | ODS/ELE/IRT/01 | 1      | C        |
| 2     | Battery-Battery Charger  | ODS/ELE/IRT/02 | 1      | B        |
| 3     | CCTV   | ODS/ELE/IRT/03 | 1      | C        |
| 4     | HV Switch Gear   | ODS/ELE/IRT/04 | 1      | B        |
| 5     | Lighting Fixture, Junction Box (For Hazardous area /safe area) | ODS/ELE/IRT/05 | 1      | C        |
| 6     | Lighting Transformer   | ODS/ELE/IRT/06 | 1      | C        |
| 7     | L V Switchgear   | ODS/ELE/IRT/07 | 1      | B        |
| 8     | Electric Motor (Above 1 kV)                                    | ODS/ELE/IRT/08 | 1      | B        |
| 9     | Electric Motor (less than 1 kV)                                | ODS/ELE/IRT/09 | 1      | C        |
| 10    | Paging and intercom system                                     | ODS/ELE/IRT/10 | 1      | B        |
| 11    | Power and Distribution Transformer                             | ODS/ELE/IRT/11 | 1      | B        |
| 12    | Radio system   | ODS/ELE/IRT/12 | 1      | C        |
| 13    | Sacrificial Anode  | ODS/ELE/IRT/13 | 1      | B        |
| 14    | SOLAR ELECTRIC POWER SYSTEM(Including Lead acid Battery)       | ODS/ELE/IRT/14 | 1      | B        |
| 15    | Subsea Cable   | ODS/ELE/IRT/15 | 1      | A        |
| 16    | Surface Electrical Cables                                      | ODS/ELE/IRT/16 | 1      | C        |
| 17    | Synchronous Generator  | ODS/ELE/IRT/17 | 1      | B        |
| 18    | UPS System (Including NiCd Battery)                            | ODS/ELE/IRT/18 | 1      | B        |
| 19    | Navigational Aids System                                       | ODS/ELE/IRT/19 | 1      | C        |
| 20    | Heat Tracing System  | ODS/ELE/IRT/20 | 1      | C        |
| 21    | Miscellaneous Bulk Item  | ODS/ELE/IRT/21 | 1      | Bulk     |

| Prepared / Revised By            | Reviewed By                    | Approved By                                  |
|----------------------------------|--------------------------------|--|
| <i>B. B. Singh</i><br>06-01-2017 | <i>[Signature]</i><br>06/11/17 | <i>[Signature]</i><br>6/1/2017<br>A. Jagdish |

|   |   |   |                        |                |
|---|---|---|------------------------|----------------|
|  | <b>Offshore Design<br/>Section<br/>Engineering<br/>Services<br/>(ISO –<br/>9001:2008)</b> | <b>INSPECTION<br/>REQUIREMENT<br/>TABLE</b> | IRT No.                | ODS/ELE/IRT/13 |
|   |   |   | Rev. No.               | 1              |
|   |   |   | Discipline             | ELECTRICAL     |
|   |   |   | Inspection Category: B |                |

|   |  |   |   |   |   |  |   |  |  |  |  |  |  |  |  |
|---|--|---|---|---|---|--|---|--|--|--|--|--|--|--|--|
| <b>Item:</b>  |  |   |   |   |   |  | <b>Sacrificial Anode (Cathodic Protection System)</b> |  |  |  |  |  |  |  |  |
| Activity No   | 1. Inspection by ONGC / Certification Agency (CA)  |   |   |   |   |  |   |  |  |  |  |  |  |  |  |
|   | 2. Inspection by ONGC / Third Party Inspector (TPI)  |   |   |   |   |  |   |  |  |  |  |  |  |  |  |
|   | 3. Inspection by EPC / EPC's Inspection Agency (IA)  |   |   |   |   |  |   |  |  |  |  |  |  |  |  |
|   | 4. Inspection by Vendor/ Sub vendor  |   |   |   |   |  |   |  |  |  |  |  |  |  |  |
|   | 5. Certificates/compliance/Data/Information to be submitted by vendor for Review/ Approval |   |   |   |   |  |   |  |  |  |  |  |  |  |  |
|   | 6. Stages of Inspection  |   |   |   |   |  |   |  |  |  |  |  |  |  |  |
| <b>General &amp; documents- For Review/Approval /Information</b>              |  |   |   |   |   |  |   |  |  |  |  |  |  |  |  |
| 1   | A  | - | R | H | X | QA Plan/ Inspection and Test Plan (To include tests as per DNV 401B, FS 4001/4002) & FAT Procedure.  |   |  |  |  |  |  |  |  |  |
| 2   | R  | - | R | H | X | Reports of Test – Type test (As per DNV including Chemical composition tests), FAT.  |   |  |  |  |  |  |  |  |  |
| 3   | R  | - | R | H | X | Review of Material Test Certificates (MTC), conformance / compliance certificate, test reports etc for all major bought out components/ items as listed in QAP.                        |   |  |  |  |  |  |  |  |  |
| <b>Inspection &amp; Testing- For Witness/ Random Witness</b>                  |  |   |   |   |   |  |   |  |  |  |  |  |  |  |  |
| 4   | W  | - | W | W | X | Visual inspection, Dimensional check, Weighing, Packaging, Workman ship,   |   |  |  |  |  |  |  |  |  |
| <b>Acceptance Test as per applicable FS 4001/4002 including the following</b> |  |   |   |   |   |  |   |  |  |  |  |  |  |  |  |
| 5   | W  | - | W | W | X | Performance Tests (Potential and capacity)   |   |  |  |  |  |  |  |  |  |
| 6   | W  | - | W | W | X | Destructive tests as per FS 4001/4002 or nondestructive radiography. (At least one anode per delivery or at least 0.5 percent of the anodes shall be subjected to destructive testing) |   |  |  |  |  |  |  |  |  |
| 7   | W  | - | W | W | X | Electrical continuity test between anode and connector (should be less than 0.005 ohm)   |   |  |  |  |  |  |  |  |  |
| <b>Routine Test</b>   |  |   |   |   |   |  |   |  |  |  |  |  |  |  |  |
| 8   | W  |   | W | W | X | As per DNV 401B  |   |  |  |  |  |  |  |  |  |
| <b>IRN For issue by CA/TPI/Contractor IA</b>                                  |  |   |   |   |   |  |   |  |  |  |  |  |  |  |  |
| 9   | Is   | - | R | H | X | Issue & Documentation at Vendor Place  |   |  |  |  |  |  |  |  |  |
| <b>IMIR/GIIR at Yard/Offshore</b>   |  |   |   |   |   |  |   |  |  |  |  |  |  |  |  |
| 10  | W  | W |   | H | X | Verification of items as per IRN   |   |  |  |  |  |  |  |  |  |
| 11  | Is   | R |   |   | X | IMIR/GIIR on the basis of IRN  |   |  |  |  |  |  |  |  |  |

LEGENDS & NOTES : Explained separately

|              |               |          |        |            |
|--------------|---------------|----------|--------|------------|
| Format No    | Ref. Proc. No | Issue No | Rev No | Rev. Date  |
| ODS/SOF/004A | ODS/SOP/023   | '01      | '00    | 08.03.2016 |



**INDEX**

| <b>S. No</b> | <b>ITEM</b>   | <b>IRT NO.</b>      | <b>Rev. No.</b> | <b>INSP. CATEGORY</b> |
|--------------|---|---------------------|-----------------|-----------------------|
| 1.           | CARBON STEEL SEAMLESS LINE PIPES ( SOUR SERVICE)                            | ODS/PIPELINE/IRT/01 | 1               | A                     |
| 2.           | CARBON STEEL SEAMLESS LINE PIPES ( NON-SOUR SERVICE)                        | ODS/PIPELINE/IRT/02 | 1               | A                     |
| 3.           | LSAW LINE PIPES ( SOUR SERVICE)   | ODS/PIPELINE/IRT/03 | 1               | A                     |
| 4.           | LSAW LINE PIPES (NON- SOUR SERVICE)   | ODS/PIPELINE/IRT/04 | 1               | A                     |
| 5.           | CRA CLAD LINE PIPES ( SOUR SERVICE)   | ODS/PIPELINE/IRT/05 | 0               | A                     |
| 6.           | LONG RADIUS BENDS   | ODS/PIPELINE/IRT/06 | 0               | B                     |
| 7.           | CRA CLAD LONG RADIUS BENDS ( SOUR SERVICE)                                  | ODS/PIPELINE/IRT/07 | 0               | B                     |
| 8.           | ANTI CORROSION COATING , CWC COATING , ANODE INSTALLATION & MONEL SHEATHING | ODS/PIPELINE/IRT/08 | 0               | A                     |
| 9.           | INTERNAL ANTI-CORROSION COATING   | ODS/PIPELINE/IRT/09 | 0               | A                     |
| 10.          | INSULATION COATING  | ODS/PIPELINE/IRT/10 | 0               | A                     |
| 11.          | NICKEL COPPER ALLOY UNS N04400 ( MONEL) PLATES AND ASSOCIATE ITEMS          | ODS/PIPELINE/IRT/11 | 0               | C                     |
| 12.          | FLEXIBLE PIPES  | ODS/PIPELINE/IRT/12 | 0               | A                     |
| 13.          | SUB-SEA BALL VALVE ( SOUR SERVICE)  | ODS/PIPELINE/IRT/13 | 0               | B                     |
| 14.          | SUB-SEA BALL VALVE ( NON-SOUR SERVICE)                                      | ODS/PIPELINE/IRT/14 | 0               | B                     |
| 15.          | SUB-SEA FLANGES ( SOUR SERVICE)   | ODS/PIPELINE/IRT/15 | 0               | B                     |
| 16.          | SUB-SEA FLANGES ( NON-SOUR SERVICE)   | ODS/PIPELINE/IRT/16 | 0               | B                     |
| 17.          | SUB-SEA FLOW TEE ( SOUR SERVICE)  | ODS/PIPELINE/IRT/17 | 0               | B                     |
| 18.          | SUB-SEA FLOW TEE ( NON-SOUR SERVICE)  | ODS/PIPELINE/IRT/18 | 0               | B                     |
| 19.          | SUB-SEA PIGGABLE WYE ( SOUR SERVICE)  | ODS/PIPELINE/IRT/19 | 0               | A                     |
| 20.          | SUB-SEA PIGGABLE WYE ( NON-SOUR SERVICE)                                    | ODS/PIPELINE/IRT/20 | 0               | A                     |
| 21.          | INSTALLATION OF RIGID PIPELINES & RISERS                                    | ODS/PIPELINE/IRT/21 | 0               | A                     |
| 22.          | PIPELINE PIGGING AND HYDROTESTING   | ODS/PIPELINE/IRT/22 | 0               | A                     |



|   |   |    |   |   |  |
|---|---|----|---|---|--|
| <b>Item: CARBON STEEL SEAMLESS LINE PIPES (SOUR SERVICE)</b>            |   |    |   |   | <b>INSPECTION CATEGORY: A</b>  |
| <b>ONGC FUNCTIONAL SPEC: 2020B Rev.5 WITH ADDENDUM 1 AND ADDENDUM 2</b> |   |    |   |   |  |
| Activity No   | 1. Inspection by ONGC or ONGC Appointed Certification Agency (CA) |    |   |   |  |
|   | 2. Inspection by LSTK contractor's inspection agency (TPI)        |    |   |   |  |
|   | 3. Inspection by Vendor/ Sub-vendor                               |    |   |   |  |
|   | 4. Certificates/ Data to be submitted by Vendor                   |    |   |   |  |
|   | Stages of Inspection  |    |   |   |  |
| <b>GENERAL &amp; DOCUMENTS -FOR REVIEW /APPROVAL/INFORMATION</b>        |   |    |   |   |  |
| 1   | A   | R  | H | X | QUALITY PLAN   |
| 2   | A   | R  | H | X | MANUFACTURING PROCEDURE SPECIFICATION  |
| 3   | A   | R  | H | X | INSPECTION TESTING PLAN  |
| 4   | R   | R  | H | X | TESTS / INSPECTION REPORTS BY VENDOR   |
| 5   | R   | R  | H | X | STARTING MATERIAL TEST CERTIFICATES / COMPLIANCE CERTIFICATES COMPLETE INCLUDING CERTIFICATES FOR INCLUSION CONTENT                |
| 6   | R   | R  | H | X | CALIBRATION CERTIFICATES / REPORTS OF TESTING EQUIPMENTS/NDT TECHNICIAN QUALIFICATION CERTIFICATES IN LINE WITH API 5L REQUIREMENT |
| 7   | R   | H  | H | X | FINAL DOCUMENTATION , MILL QUALIFICATION TEST REPORTS, FDPT, MILL PRODUCTION REPORTS   |
| 8   | R   | R  | H | X | PIPE MANUFACTURING DATA BOOK AS PER CL. 10.1.3.2   |
| <b>INSPECTION AND TESTING- FOR WITNESS/ RANDOM WITNESS</b>              |   |    |   |   |  |
| 9   | RW  | W  | H | X | STARTING MATERIAL IDENTIFICATION   |
| 10  | RW  | W  | H | X | CALIBRATION OF EQUIPMENTS/ INSTRUMENTS   |
| 11  | W   | W  | H | X | MILL QUALIFICATION TEST CERTIFICATION  |
| 12  | RW  | W  | H | X | FIRST DAY PRODUCTION SAMPLING AND TESTING FOR MECHANICAL, CHEMICAL & CORROSION TESTS   |
| 13  | RW  | RW | H | X | INPROCESS PARAMETER CHECK, HEAT TREATMENT, STEEL MAKING PROCESS CHECK, BILLET HEAT NUMBER VERIFICATION                             |
| 14  | RW  | W  | H | X | PRODUCTION TEST SAMPLING AND TESTING FOR MECHANICAL, CHEMICAL, CORROSION & SUPPLEMENTARY TESTS                                     |
| 15  | RW  | W  | H | X | PIPE END/ BEVEL & HYDROTESTING CHECK   |
| 16  | RW  | W  | H | X | ALL DESTRUCTIVE AND NDT AS PER STANDARD & SUPPLEMENTARY REQUIREMENTS AS PER THE SPEC WITH ADDENDUM                                 |
| 17  | RW  | RW | H | X | PIPE END DEMAGNETISING   |
| 18  | RW  | W  | H | X | FINAL DIMENSIONAL, VISUAL CHECK, WEIGHT CHECK, MARKING, DIE STAMPING AND BEVEL PROTECTORS ETC.                                     |
| <b>IRN FOR ISSUE BY CA/TPI/CONTRACTOR IA</b>                            |   |    |   |   |  |
| 19  | Is  | R  | - | - | ISSUE OF INSPECTION RELEASE NOTE AT VENDOR'S PLACE   |
| <b>** OTHER REQUIREMENT**</b>   |   |    |   |   |  |
| 20  | RW  | RW | H | X | CHECK PREPARATION FOR SHIPMENT   |

The Activities listed above are not exhaustive. Inspection of other activities shall be carried out as per requirement of the FS.

Legend & Notes : Explained Separately.



|  |   |    |   |   |  |
|--|---|----|---|---|--|
| <b>Item: CARBON STEEL SEAMLESS LINE PIPES (NON-SOUR SERVICE)</b> |   |    |   |   | <b>INSPECTION CATEGORY: A</b>  |
| <b>ONGC FUNCTIONAL SPEC: 2020A Rev.5 WITH ADDENDUM</b>           |   |    |   |   |  |
| Activity No  | 1. Inspection by ONGC or ONGC Appointed Certification Agency (CA) |    |   |   |  |
|  | 2. Inspection by LSTK contractor's inspection agency (TPI)        |    |   |   |  |
|  | 3. Inspection by Vendor/ Sub-vendor                               |    |   |   |  |
|  | 4. Certificates/ Data to be submitted by Vendor                   |    |   |   |  |
|  | Stages of Inspection  |    |   |   |  |
| <b>GENERAL &amp; DOCUMENTS -FOR REVIEW /APPROVAL/INFORMATION</b> |   |    |   |   |  |
| 1  | A   | R  | H | X | QUALITY PLAN   |
| 2  | A   | R  | H | X | MANUFACTURING PROCEDURE SPECIFICATION  |
| 3  | A   | R  | H | X | INSPECTION TESTING PLAN  |
| 4  | R   | R  | H | X | TESTS / INSPECTION REPORTS BY VENDOR   |
| 5  | R   | R  | H | X | MATERIAL TEST CERTIFICATES / COMPLIANCE CERTIFICATES COMPLETE INCLUDING CERTIFICATES FOR INCLUSION CONTENT |
| 6  | R   | R  | H | X | CALIBRATION CERTIFICATES / REPORTS OF TESTING EQUIPMENTS/NDT TECHNICIAN QUALIFICATION CERTIFICATES         |
| 7  | R   | H  | H | X | FINAL DOCUMENTATION, FDPT, MILL PRODUCTION REPORTS   |
| 8  | R   | R  | H | X | PIPE MANUFACTURING DATA BOOK   |
| <b>INSPECTION AND TESTING- FOR WITNESS/ RANDOM WITNESS</b>       |   |    |   |   |  |
| 9  | RW  | W  | H | X | MATERIAL IDENTIFICATION  |
| 10   | RW  | W  | H | X | CALIBRATION OF EQUIPMENTS/ INSTRUMENTS   |
| 11   | RW  | W  | H | X | FIRST DAY PRODUCTION SAMPLING AND TESTING FOR MECHANICAL & CHEMICAL TESTS                                  |
| 12   | RW  | RW | H | X | INPROCESS PARAMETER CHECK, HEAT TREATMENT, STEEL MAKING PROCESS CHECK, BILLET HEAT NUMBER VERIFICATION     |
| 13   | RW  | W  | H | X | PRODUCTION TEST SAMPLING AND TESTING FOR MECHANICAL, CHEMICAL & SUPPLEMENTARY TESTS                        |
| 14   | RW  | W  | H | X | PIPE END/ BEVEL & HYDROTESTING CHECK   |
| 15   | RW  | W  | H | X | ALL DESTRUCTIVE AND NDT AS PER STANDARD & SUPPLEMENTARY REQUIREMENTS AS PER SPEC.                          |
| 16   | RW  | RW | H | X | PIPE END DEMAGNETISING   |
| 17   | RW  | W  | H | X | FINAL DIMENSIONAL, VISUAL CHECK, WEIGHT CHECK, MARKING, DIE STAMPING AND BEVEL PROTECTORS ETC.             |
| <b>IRN FOR ISSUE BY CA/TPI/CONTRACTOR IA</b>                     |   |    |   |   |  |
| 18   | Is  | R  | - | - | ISSUE OF INSPECTION RELEASE NOTE AT VENDOR'S PLACE   |
| <b>** OTHER REQUIREMENT**</b>                                    |   |    |   |   |  |
| 19   | RW  | RW | H | X | CHECK PREPARATION FOR SHIPMENT   |

The Activities listed above are not exhaustive. Inspection of other activities shall be carried out as per requirement of the FS.

Legend & Notes : Explained Separately.





|   |   |    |   |   |  |
|---|---|----|---|---|--|
| <b>Item: LONGITUDINAL SEAM SUBMERGED ARC WELDED LINEPIPE FOR SUBMARINE PIPELINES (SOUR SERVICE)</b> |   |    |   |   | <b>INSPECTION CATEGORY: A</b>  |
| <b>ONGC FUNCTIONAL SPEC: 2020D REV.2 WITH ADDENDUM 1 AND ADDENDUM 2</b>                             |   |    |   |   |  |
| <b>Activity No</b>  | 1. Inspection by ONGC or ONGC Appointed Certification Agency (CA) |    |   |   |  |
|   | 2. Inspection by LSTK contractor's inspection agency (TPI)        |    |   |   |  |
|   | 3. Inspection by Vendor/ Sub-vendor                               |    |   |   |  |
|   | 4. Certificates/ Data to be submitted by Vendor                   |    |   |   |  |
|   | Stages of Inspection  |    |   |   |  |
| <b>GENERAL &amp; DOCUMENTS -FOR REVIEW /APPROVAL/INFORMATION</b>                                    |   |    |   |   |  |
| 1   | A   | R  | H | X | QUALITY PLAN   |
| 2   | A   | R  | H | X | MANUFACTURING PROCEDURE SPECIFICATION  |
| 3   | A   | R  | H | X | INSPECTION TESTING PLAN  |
| 4   | R   | R  | H | X | TESTS / INSPECTION REPORTS BY VENDOR   |
| 5   | R   | R  | H | X | MATERIAL TEST CERTIFICATES / COMPLIANCE CERTIFICATES COMPLETE INCLUDING CERTIFICATES FOR INCLUSION CONTENT |
| 6   | R   | R  | H | X | CALIBRATION CERTIFICATES / REPORTS OF TESTING EQUIPMENTS/NDT TECHNICIAN QUALIFICATION CERTIFICATES         |
| 7   | R   | R  | H | X | WPS/PQR AND WPQ'S  |
| 8   | R   | H  | H | X | FINAL DOCUMENTATION , MILL QUALIFICATION TEST REPORTS, FDPT, MILL PRODUCTION REPORTS                       |
| 9   | R   | R  | H | X | PIPE MANUFACTURING DATA BOOK   |
| <b>INSPECTION AND TESTING- FOR WITNESS/ RANDOM WITNESS</b>  |   |    |   |   |  |
| 10  | RW  | W  | H | X | MATERIAL IDENTIFICATION  |
| 11  | RW  | W  | H | X | CALIBRATION OF EQUIPMENTS/ INSTRUMENTS   |
| 12  | W   | W  | H | X | MILL QUALIFICATION TEST CERTIFICATION  |
| 13  | RW  | W  | H | X | FIRST DAY PRODUCTION SAMPLING AND TESTING FOR MECHANICAL, CHEMICAL & CORROSION TESTS                       |
| 14  | RW  | W  | H | X | PRODUCTION TEST SAMPLING AND TESTING FOR MECHANICAL, CHEMICAL, CORROSION & SUPPLEMENTARY TESTS             |
| 15  | RW  | W  | H | X | PIPE END/ BEVEL & HYDROTESTING CHECK   |
| 16  | RW  | W  | H | X | ALL DESTRUCTIVE AND NDT AS PER STANDARD & SUPPLEMENTARY REQUIREMENTS AS PER SPEC WITH ADDENDUM             |
| 17  | RW  | RW | H | X | PIPE END DEMAGNETISING   |
| 18  | RW  | W  | H | X | FINAL DIMENSIONAL, VISUAL CHECK, WEIGHT CHECK, MARKING, DIE STAMPING AND BEVEL PROTECTORS ETC.             |
| <b>IRN FOR ISSUE BY CA/TPI/CONTRACTOR IA</b>  |   |    |   |   |  |
| 19  | Is  | R  | - | - | ISSUE OF INSPECTION RELEASE NOTE AT VENDOR'S PLACE   |
| <b>** OTHER REQUIREMENT**</b>   |   |    |   |   |  |
| 20  | RW  | RW | H | X | CHECK PREPARATION FOR SHIPMENT   |

The Activities listed above are not exhaustive. Inspection of other activities shall be carried out as per requirement of the FS.

Legend & Notes : Explained Separately.



|  |   |    |   |   |   |
|--|---|----|---|---|---|
| <b>Item: LONG RADIUS BENDS</b>                                   |   |    |   |   | <b>INSPECTION CATEGORY: B</b>   |
| <b>ONGC FUNCTIONAL SPEC: 2018</b>                                |   |    |   |   |   |
| Activity No  | 1. Inspection by ONGC or ONGC Appointed Certification Agency (CA) |    |   |   |   |
|  | 2. Inspection by LSTK contractor's inspection agency (TPI)        |    |   |   |   |
|  | 3. Inspection by Vendor/ Sub-vendor                               |    |   |   |   |
|  | 4. Certificates/ Data to be submitted by Vendor                   |    |   |   |   |
|  | Stages of Inspection  |    |   |   |   |
| <b>GENERAL &amp; DOCUMENTS -FOR REVIEW /APPROVAL/INFORMATION</b> |   |    |   |   |   |
| 1  | A   | R  | H | X | INSPECTION AND TEST PLAN  |
| 2  | A   | R  | H | X | INSPECTION TESTING AND MANUFACTURING PROCEDURE  |
| 3  | R   | R  | H | X | TESTS / INSPECTION REPORTS BY VENDOR  |
| 4  | R   | R  | H | X | PIPE LONG RADIUS BENDS VENDOR DOSSIER, MATERIAL TEST CERTIFICATES / COMPLIANCE CERTIFICATES   |
| 5  | R   | R  | H | X | CALIBRATION CERTIFICATES/ REPORTS OF TESTING EQUIPMENTS   |
| 6  | R   | H  | H | X | FINAL DOCUMENTATION   |
| <b>INSPECTION AND TESTING- FOR WITNESS/ RANDOM WITNESS</b>       |   |    |   |   |   |
| 7  | RW  | W  | H | X | MATERIAL IDENTIFICATION AND VERIFICATION OF TRACEABILITY RECORDS  |
| 8  | W   | W  | H | X | MANUFACTURING PROCEDURE QUALIFICATION TEST ALONG WITH MECHANICAL,CHEMICAL AND CORROSION TESTING   |
| 9  | W   | W  | H | X | FINAL VISUAL AND DIMENSIONAL & TOLERANCE CHECK,BEND ANGLE,BEND RADIUS,OVALITY,WALL THICKNESS,OFF-PLANE, BEVEL CHECK AND ALL OTHER TESTS AS PER SPEC 2018 REV0 |
| 10   | W   | W  | H | X | RUNNING OF GAUGING PIG CHECK  |
| 11   | W   | W  | H | X | NDE REQUIREMENT (RT/UT/MPI/DPT-AS AS PER ONGC SPEC)   |
| 12   | W   | W  | H | X | HYDROSTATIC PRESSURE TEST   |
| 13   | W   | H  | H | X | VERIFICATION OF MARKING   |
| <b>IRN FOR ISSUE BY CA/TPI/CONTRACTOR IA</b>                     |   |    |   |   |   |
| 14   | Is  | R  | - | - | ISSUE OF INSPECTION RELEASE NOTE AT VENDOR'S PLACE  |
| <b>** OTHER REQUIREMENT**</b>                                    |   |    |   |   |   |
| 15   | RW  | RW | H | X | CHECK PREPARATION FOR SHIPMENT  |

The Activities listed above are not exhaustive. Inspection of other activities shall be carried out as per requirement of the FS.

Legend & Notes : Explained Separately.



|  |                               |
|--|-------------------------------|
| <b>Item:</b> ANTI-CORROSION COATING (3 LAYER POLYPROPYLENE), CONCRETE WEIGHT COATING, AND ANODE INSTALLATION | <b>INSPECTION CATEGORY: A</b> |
| <b>ONGC FUNCTIONAL SPEC: 2012A, 2013, 4002 AND 2015</b>  |                               |

|  |   |    |    |   |   |  |
|--|---|----|----|---|---|--|
| Activity No  | 1. Inspection by ONGC or ONGC Appointed Certification Agency (CA)                 |    |    |   |   |  |
|  | 2. Inspection by ONGC Appointed Third Party Inspection Agency (TPI)               |    |    |   |   |  |
|  | 3. Inspection by Contractor or Contractor appointed Third Party Inspection Agency |    |    |   |   |  |
|  | 4. Inspection by Vendor / Sub Vendor  |    |    |   |   |  |
|  | 5. Certificate / Data to be submitted by Vendor for Review / Approval             |    |    |   |   |  |
| STAGES OF INSPECTION   |   |    |    |   |   |  |
| <b>GENERAL &amp; DOCUMENTS -FOR REVIEW /APPROVAL/INFORMATION</b>   |   |    |    |   |   |  |
| 1.   | A   | R  | R  | H | X | INSPECTION AND TEST PLAN (COVERING ALL STAGES OF RAW MATERIALS)  |
| 2.   | A   | R  | R  | H | X | PRE-QUALIFICATION TEST PROCEDURE OF ANTI-CORROSION COATING, CONCRETE WEIGHT COATING & ANODE INSTALLATION   |
| 3.   | R   | R  | R  | H | X | VENDOR DOSSIER FOR AS INSTALLED INCLUDING TEST CERTIFICATES OF ANTI CORROSION COATING, CONCRETE COATING, ANODE INSTALLATION & MONEL SHEATHING  |
| 4.   | R   | R  | H  | H | X | FINAL DOCUMENTATION  |
| <b>INSPECTION AND TESTING- FOR WITNESS/ RANDOM WITNESS</b>   |   |    |    |   |   |  |
| <b>BARE LINE PIPE, LONG RADIUS BENDS, SUBSEA BALL VALVES, FLANGES &amp;ALL OTHER PIPELINE ITEMS.<br/>RECEIPT AT YARD</b> |   |    |    |   |   |  |
| 5.   | RW  | RW | RW | H | X | VISUAL INSPECTION OF PIPES, LR BENDS, SUBSEA BALL VALVES, FLANGES& ALL OTHER PIPELINE ITEMS ETC. AT YARD, VERIFICATION WITH PIPE TALLY SHEETS ALONG WITH TRANSFER OF PIPE IDENTIFICATION NOS. AND ISSUE OF IMIR/GIIR |
| <b>ANODE INSTALLATION</b>  |   |    |    |   |   |  |
| 5.   | RW  | RW | RW | H | X | VISUAL INSPECTION OF ANODE.  |
| 6.   | RW  | RW | RW | H | X | INSTALLATION & THERMITE WELDING.   |
| 7.   | RW  | RW | RW | H | X | VISUAL INSPECTION OF ANODE SHARP WELDS.  |
| 8.   | RW  | RW | RW | H | X | MPI AN ANODE SHARP WELD.   |
| 9.   | RW  | RW | RW | H | X | ELECTRICAL CONTINUITY CHECK.   |
| 10.  | RW  | RW | RW | H | X | COAL-TAR FILL-UP IN JOINT GAPS.  |
| <b>ANTI-CORROSION COATING</b>  |   |    |    |   |   |  |
| 11.  | RW  | RW | RW | H | X | RAW MATERIAL IDENTIFICATION AND REVIEW OF MANUFACTURER'S TEST CERTIFICATES AS PER PROJECT SPECIFICATION ONGC SPEC 2012A  |
| 12.  | RW  | RW | RW | H | X | SAMPLE TESTING OF PROCURED FBE POWDER, PP & ADHESIVE.  |
| 13.  | RW  | RW | RW | H | X | PROCEDURE QUALIFICATION TESTING FOR 3LPP CORROSION COATING AS PER PROCEDURE AS PER APPENDIX 1 OF SPEC.2012.  |
| 14.  | RW  | RW | RW | H | X | CHECK SURFACE CONDITION BEFORE BLASTING, PREHEATING.   |
| 15.  | RW  | RW | RW | H | X | CLEANLINESS OF BLAST CLEANED SURFACE   |
| 16.  | RW  | RW | RW | H | X | SURFACE PROFILE CHECK.   |



|                         |   |    |    |   |   |  |
|-------------------------|---|----|----|---|---|--|
| Activity No             | 1. Inspection by ONGC or ONGC Appointed Certification Agency (CA)                 |    |    |   |   |  |
|                         | 2. Inspection by ONGC Appointed Third Party Inspection Agency (TPI)               |    |    |   |   |  |
|                         | 3. Inspection by Contractor or Contractor appointed Third Party Inspection Agency |    |    |   |   |  |
|                         | 4. Inspection by Vendor / Sub Vendor  |    |    |   |   |  |
|                         | 5. Certificate / Data to be submitted by Vendor for Review / Approval             |    |    |   |   |  |
|                         |   |    |    |   |   | STAGES OF INSPECTION   |
| 17.                     | RW  | RW | RW | H | X | PHOSPHORIC ACID PRE-TREATMENT.   |
| 18.                     | RW  | RW | RW | H | X | CHOLORIDE CONTENT CHECK.   |
| 19.                     | RW  | RW | RW | H | X | CHECK PIPE SURFACE TEMPERATURE & COATING APPLICATION TEMPERATURE.                                    |
| 20.                     | RW  | RW | RW | H | X | ANTI-CORROSION COATING.  |
| 21.                     | RW  | RW | RW | H | X | VISUAL CHECK.  |
| 22.                     | RW  | RW | RW | H | X | COATING THICKNESS CHECK.   |
| 23.                     | RW  | W  | W  | H | X | HOLIDAY TESTING.   |
| 24.                     | W   | W  | W  | H | X | ADHESION TESTING   |
| 25.                     | RW  | RW | W  | H | X | PENETRATION INDENTATION TEST.  |
| 26.                     | RW  | RW | W  | H | X | IMPACT TEST.   |
| 27.                     | RW  | RW | RW | H | X | CATHODIC DISBONDING CHECK.   |
| 28.                     | RW  | RW | RW | H | X | AIR ENTRAPMENT (POROSITY) ASSESSMENT.  |
| 29.                     | RW  | RW | RW | H | X | DEGREE OF CURE   |
| 30.                     | W   | W  | W  | H | X | DESTRUCTIVE TESTS.   |
| 31.                     | W   | W  | W  | H | X | REPAIRS IF ANY.  |
| 32.                     | RW  | RW | W  | H | X | HANDLING & STORAGE OF PIPES.   |
| 33.                     | RW  | RW | W  | H | X | MARKING AND TRACEABILITY CHECK.  |
| <b>CONCRETE COATING</b> |   |    |    |   |   |  |
| 34.                     | W   | W  | W  | H | X | PROCEDURE QUALIFICATION FOR CONCRETE MIX AND APPLICATION AS PER PROJECT SPECIFICATION ONGC SPEC 2013 |
| 35.                     | RW  | RW | RW | H | X | CHECK FOR GRADING AND PURITY OF SAND AND AGGREGATE, CHECK FOR PURITY OF WATER.                       |
| 36.                     | RW  | RW | RW | H | X | CHECK FOR REINFORCEMENT STEEL.   |
| 37.                     | RW  | RW | RW | H | X | HOLIDAY DETECTION/MEGGERING TEST   |
| 38.                     | RW  | RW | RW | H | X | CALIBRATION FOR WEIGHING EQUIPMENT.  |
| 39.                     | RW  | RW | W  | H | X | VISUAL, DIMENSIONAL & TOLERANCE CHECK.   |
| 40.                     | RW  | RW | W  | H | X | -SATURATED WEIGHT TEST<br>-STRENGTH(IN 7 DAYS, 28 DAYS) AND DENSITY TEST<br>-WATER ABSORPTION TEST   |
| 41.                     | W   | W  | W  | H | X | SHEAR TEST (PUSH OFF TEST).  |
| 42.                     | RW  | RW | RW | H | X | MEASUREMENT & LOGGING OF EACH PIPE CONCRETE COATING.   |
| 43.                     | RW  | RW | RW | H | X | WET & DRY WEIGHING OF COATED PIPE.   |



|  |   |    |    |   |   |  |
|--|---|----|----|---|---|--|
| Activity No  | 1. Inspection by ONGC or ONGC Appointed Certification Agency (CA)                 |    |    |   |   |  |
|  | 2. Inspection by ONGC Appointed Third Party Inspection Agency (TPI)               |    |    |   |   |  |
|  | 3. Inspection by Contractor or Contractor appointed Third Party Inspection Agency |    |    |   |   |  |
|  | 4. Inspection by Vendor / Sub Vendor  |    |    |   |   |  |
|  | 5. Certificate / Data to be submitted by Vendor for Review / Approval             |    |    |   |   |  |
| <b>STAGES OF INSPECTION</b>  |   |    |    |   |   |  |
| <b>FABRICATION AND INSTALLATION OF NICKEL – COPPER ALLOY UNS N04400 (MONEL) PLATES AND ASSOCIATE ITEMS</b> |   |    |    |   |   |  |
| 44.  | A   | R  | R  | H | X | INSPECTION AND TEST PLAN   |
| 45.  | RW  | W  | W  | H | X | MATERIAL IDENTIFICATION & MATERIAL TEST CERTIFICATES AND TRACEABILITY RECORDS AS PER CLAUSE 8.13 OF ONGC SPEC 2015 REV 1 |
| 46.  | A   | R  | W  | H | X | WPS/PQR/WPQ  |
| 47.  | W   | W  | W  | H | X | VISUAL, DIMENSIONAL CHECK , FABRICATION AND WELDING  |
| 48.  | RW  | RW | W  | H | X | NDT  |
| 49.  | W   | W  | W  | H | X | LEAK TEST  |
| <b>FINAL</b>   |   |    |    |   |   |  |
| 50.  | RW  | RW | RW | H | X | REPAIRS, MARKING AS PER PROJECT SPECIFICATION.   |
| 51.  | RW  | RW | RW | H | X | VERIFY CUT BACK OF CWC & 3LPP COATING.   |
| 52.  | RW  | RW | RW | H | X | CHECK FOR BEVEL END PROTECTIONS AND INTERNAL & END CLEANING.   |
| 53.  | RW  | RW | RW | H | X | REVIEW OF DETAILED CORRELATION CHART, TALLY SHEETS AT VENDOR PLACE.  |
| <b>IRN FOR ISSUE BY CA/TPI/CONTRACTOR IA</b>   |   |    |    |   |   |  |
| 54.  | Is  | R  | R  | - |   | ISSUE OF INSPECTION RELEASE NOTE AT VENDOR'S PLACE   |

The Activities listed above are not exhaustive. Inspection of other activities shall be carried out as per requirement of the FS.

Legend & Notes : Explained Separately.



**Offshore Design Section  
Engineering Services  
ISO – 9001:2008**

**INSPECTION  
REQUIREMENT TABLE**

|                     |                            |
|---------------------|----------------------------|
| <b>IRT No.</b>      | <b>ODS/PIPELINE/IRT/09</b> |
| <b>Rev. No.</b>     | <b>0</b>                   |
| <b>Discipline</b>   | <b>PIPELINE</b>            |
| <b>Page: 1 OF 1</b> |                            |

|  |                               |
|--|-------------------------------|
| <b>Item: INTERNAL ANTI-CORROSION COATING</b> | <b>Inspection Category: A</b> |
| <b>ONGC FUNCTIONAL SPEC: TBA</b>             |                               |

|                                |   |    |    |   |   |   |
|--------------------------------|---|----|----|---|---|---|
| Activity No                    | 1. Inspection by ONGC or ONGC Appointed Certification Agency (CA)                 |    |    |   |   |   |
|                                | 2. Inspection by ONGC Appointed Third Party Inspection Agency (TPI)               |    |    |   |   |   |
|                                | 3. Inspection by Contractor or Contractor appointed Third Party Inspection Agency |    |    |   |   |   |
|                                | 4. Inspection by Vendor / Sub Vendor  |    |    |   |   |   |
|                                | 5. Certificate / Data to be submitted by Vendor for Review / Approval             |    |    |   |   |   |
|                                |   |    |    |   |   | <b>STAGES OF INSPECTION</b>   |
|                                |   |    |    |   |   | <b>GENERAL &amp; DOCUMENTS -FOR REVIEW /APPROVAL / INFORMATION</b>  |
| 1.                             | A   | R  | R  | H | X | INSPECTION AND TEST PLAN  |
| 2.                             | A   | R  | R  | H | X | INSPECTION TESTING AND APPLICATION PROCEDURE  |
| 3.                             | R   | R  | R  | H | X | TESTS / INSPECTION REPORTS BY VENDOR  |
| 4.                             | R   | R  | R  | H | X | MATERIAL TEST CERTIFICATES / COMPLIANCE CERTIFICATES  |
| 5.                             | R   | R  | R  | H | X | CALIBRATION CERTIFICATES / REPORTS OF TESTING EQUIPMENTS  |
|                                |   |    |    |   |   | <b>INSPECTION AND TESTING- FOR WITNESS/ RANDOM WITNESS</b>  |
|                                |   |    |    |   |   | <b>BARE LINE PIPE RECEIPT AT YARD</b>   |
| 6.                             | RW  | RW | RW | H | X | VISUAL INSPECTION OF PIPES, LR BENDS, ALL OTHER PIPELINE ITEMS ETC. AT YARD, VERIFICATION WITH PIPE TALLY SHEETS ALONG WITH TRANSFER OF PIPE IDENTIFICATION NOS. AND ISSUE OF IMIR/GIIR |
| 7.                             | RW  | RW | W  | H | X | RAW MATERIAL IDENTIFICATION AND REVIEW OF MANUFACTURER TEST CERTIFICATES  |
| 8.                             | RW  | RW | W  | H | X | SAMPLE TESTING OF RAW MATERIAL  |
| 9.                             | RW  | RW | RW | H | X | INTERNAL SURFACE INSPECTION , CLEANING , SURFACE ANCHOR PROFILE AS PER SPECIFICATION  |
| 10.                            | W   | W  | W  | H | X | PRE QUALIFICATION TESTING- SAMPLING, TESTING & INSPECTION AS PER SPECIFICATION REQUIREMENT  |
| 11.                            | RW  | RW | W  | H | X | PRODUCTION SAMPLING, TESTING & INSPECTION AS PER SPECIFICATION REQUIREMENT  |
| 12.                            | RW  | W  | W  | H | X | MATERIAL CONTROL RECORDS AND REPAIR OF INTERNAL COATING AS PER APPROVED PROCEDURE AND PROJECT SPECIFIC REQUIREMENT  |
| 13.                            | RW  | RW | W  | H | X | MARKING, QUALITY ASSURANCE AND DOCUMENT REVIEW  |
|                                |   |    |    |   |   | <b>IRN FOR ISSUE BY CA/TPI/CONTRACTOR IA</b>  |
| 14.                            | Is  | R  | R  | - | - | ISSUE OF INSPECTION RELEASE NOTE AT VENDOR'S PLACE  |
| <b>** OTHER REQUIREMENT **</b> |   |    |    |   |   |   |
| 15.                            | RW  | RW | W  | H | X | CHECK PREPARATION FOR SHIPMENT  |

The Activities listed above are not exhaustive. Inspection of other activities shall be carried out as per requirement of the FS.  
Legend & Notes : Explained Separately.

|              |                    |           |          |            |
|--------------|--------------------|-----------|----------|------------|
| FORMAT No.   | Ref. PROCEDURE No. | ISSUE No. | REV. No. | REV. DATE: |
| ODS/SOF/004A | ODS/SOP/023        | 01        | 00       | 08.03.2016 |



**Offshore Design Section  
Engineering Services  
ISO – 9001:2008**

**INSPECTION  
REQUIREMENT TABLE**

|                     |                            |
|---------------------|----------------------------|
| <b>IRT No.</b>      | <b>ODS/PIPELINE/IRT/15</b> |
| <b>Rev. No.</b>     | <b>0</b>                   |
| <b>Discipline</b>   | <b>PIPELINE</b>            |
| <b>Page: 1 OF 1</b> |                            |

|   |   |   |   |   |  |
|---|---|---|---|---|--|
| <b>Item: SUBSEA FLANGES (SOUR SERVICE)</b>                        |   |   |   |   | <b>INSPECTION CATEGORY: B</b>  |
| <b>ONGC SPEC: 2024 B</b>  |   |   |   |   |  |
| Activity No   | 1. Inspection by ONGC or ONGC Appointed Certification Agency (CA) |   |   |   |  |
|   | 2. Inspection by LSTK contractor's inspection agency (TPI)        |   |   |   |  |
|   | 3. Inspection by Vendor/ Sub-vendor                               |   |   |   |  |
|   | 4. Certificates/ Data to be submitted by Vendor                   |   |   |   |  |
|   | Stages of Inspection  |   |   |   |  |
| <b>GENERAL &amp; DOCUMENTS -FOR REVIEW /APPROVAL /INFORMATION</b> |   |   |   |   |  |
| 1   | A   | R | H | X | QUALITY PLAN   |
| 2   | A   | R | H | X | INSPECTION AND TESTING PROCEDURE   |
| 3   | R   | R | H | X | MATERIAL TEST AND CORROSION TESTS CERTIFICATES AS PER ONGC SPEC 2024B REV 0                        |
| 4   | R   | R | H | X | DIMENSIONAL CHECK REPORTS, VENDOR AS BUILT DOSSIER CONTAINING DRAWINGS, DATA SHEETS & CALCULATIONS |
| 5   | R   | W | H | X | SURFACE PREPARATION AND PROTECTIVE COATING AS PER ONGC SPEC 2005                                   |
| 6   | R   | H | H | X | FINAL DOCUMENTATION REVIEW   |
| <b>INSPECTION AND TESTING- FOR WITNESS/ RANDOM WITNESS</b>        |   |   |   |   |  |
| 7   | RW  | W | H | X | MATERIAL IDENTIFICATION  |
| 8   | RW  | W | H | X | NDE REQUIREMENTS   |
| 9   | RW  | W | H | X | MECHANICAL, CHEMICAL, CORROSION, AND ALL OTHER TESTS IN COMPLIANCE WITH ONGC SPEC 2024B REV 0.     |
| 10  | W   | W | H | X | FINAL VISUAL AND DIMENSIONAL CHECK   |
| <b>IRN FOR ISSUE BY CA/TPI/CONTRACTOR IA</b>                      |   |   |   |   |  |
| 11  | Is  | R | - | - | ISSUE OF INSPECTION RELEASE NOTE AT VENDOR'S PLACE   |
| <b>** OTHER REQUIREMENT**</b>                                     |   |   |   |   |  |
| 12  | RW  | W | H | X | CHECK PREPARATION FOR SHIPMENT   |

The Activities listed above are not exhaustive. Inspection of other activities shall be carried out as per requirement of the FS.

Legend & Notes : Explained Separately.

|              |                    |           |          |            |
|--------------|--------------------|-----------|----------|------------|
| FORMAT No.   | Ref. PROCEDURE No. | ISSUE No. | REV. No. | REV. DATE: |
| ODS/SOF/004A | ODS/SOP/023        | 01        | 00       | 08.03.2016 |

|   |   |   |                     |                            |
|---|---|---|---------------------|----------------------------|
|  | <b>Offshore Design Section<br/>Engineering Services<br/>ISO – 9001:2008</b> | <b>INSPECTION<br/>REQUIREMENT TABLE</b> | <b>IRT No.</b>      | <b>ODS/PIPELINE/IRT/16</b> |
|   |   |   | <b>Rev. No.</b>     | <b>0</b>                   |
|   |   |   | <b>Discipline</b>   | <b>PIPELINE</b>            |
|   |   |   | <b>Page: 1 OF 1</b> |                            |

|   |   |   |   |   |  |
|---|---|---|---|---|--|
| <b>ITEM: SUBSEA FLANGES (NON-SOUR SERVICE)</b>                    |   |   |   |   | <b>INSPECTION CATEGORY: B</b>  |
| <b>ONGC FUNCTIONAL SPEC: 2024 A</b>                               |   |   |   |   |  |
| Activity No   | 1. Inspection by ONGC or ONGC Appointed Certification Agency (CA) |   |   |   |  |
|   | 2. Inspection by LSTK contractor's inspection agency (TPI)        |   |   |   |  |
|   | 3. Inspection by Vendor/ Sub-vendor                               |   |   |   |  |
|   | 4. Certificates/ Data to be submitted by Vendor                   |   |   |   |  |
|   | Stages of Inspection  |   |   |   |  |
| <b>GENERAL &amp; DOCUMENTS -FOR REVIEW /APPROVAL /INFORMATION</b> |   |   |   |   |  |
| 1   | A   | R | H | X | QUALITY PLAN   |
| 2   | A   | R | H | X | INSPECTION AND TESTING PROCEDURE   |
| 3   | R   | R | H | X | MATERIAL TEST CERTIFICATES AS PER ONGC SPEC 2024A  |
| 4   | R   | R | H | X | DIMENSIONAL CHECK REPORTS, VENDOR AS BUILT DOSSIER CONTAINING DRAWINGS, DATA SHEETS & CALCULATIONS |
| 5   | R   | W | H | X | SURFACE PREPARATION AND PROTECTIVE COATING AS PER ONGC SPEC 2005                                   |
| 6   | A   | H | H | X | FINAL DOCUMENTATION REVIEW   |
| <b>INSPECTION AND TESTING- FOR WITNESS/ RANDOM WITNESS</b>        |   |   |   |   |  |
| 7   | RW  | W | H | X | MATERIAL IDENTIFICATION  |
| 8   | RW  | W | H | X | NDE REQUIREMENTS   |
| 9   | RW  | W | H | X | MECHANICAL, CHEMICAL AND ALL OTHER TESTS IN COMPLIANCE WITH ONGC SPEC 2024A REV 0.                 |
| 10  | W   | W | H | X | FINAL VISUAL AND DIMENSIONAL CHECK   |
| <b>IRN FOR ISSUE BY CA/TPI/CONTRACTOR IA</b>                      |   |   |   |   |  |
| 11  | Is  | R | - | - | ISSUE OF INSPECTION RELEASE NOTE AT VENDOR'S PLACE   |
| <b>** OTHER REQUIREMENT**</b>                                     |   |   |   |   |  |
| 12  | RW  | W | H | X | CHECK PREPARATION FOR SHIPMENT   |

The Activities listed above are not exhaustive. Inspection of other activities shall be carried out as per requirement of the FS.

Legend & Notes : Explained Separately.

|              |                    |           |          |            |
|--------------|--------------------|-----------|----------|------------|
| FORMAT No.   | Ref. PROCEDURE No. | ISSUE No. | REV. No. | REV. DATE: |
| ODS/SOF/004A | ODS/SOP/023        | 01        | 00       | 08.03.2016 |





| Item: Installation of Rigid Pipelines & Risers |   |   |   | INSPECTION CATEGORY: A  |
|--|---|---|---|---|
| ONGC FUNCTIONAL SPEC: 2015                     |   |   |   |   |
| Activity No                                    | 1. Inspection by ONGC or ONGC Appointed Certification Agency (CA) |   |   |   |
|  | 2. Inspection by ONGC's inspection agency (TPI)                   |   |   |   |
| Activity No                                    | 3. Inspection by Contractor/ Sub-Contractor                       |   |   |   |
|  | Stages of Inspection  |   |   |   |
|  |   |   |   | <b>Material Receiving, Storage and Handling on Offshore Barge</b>   |
| 1  | R   | R | P | All permanent Project Materials conforms to Specifications and Approved by Client/ TPI  |
| 2  | RW  | W | P | All material damages found shall be Identified, marked , recorded, segregated, stacked separately and informed to Client  |
| 3  | RW  | W | P | Ensure that all line pipes are having bevel protectors/ end caps. Records shall include photographs showing bevel protectors/ end caps at various stages during storage and transport   |
| 4  | R   | R | P | Ensure Non- conforming report is made for materials not conforming to requirements  |
| 5  | R   | R | P | Ensure all records and reports are maintained for all activities for submission in As-built Dossier to ONGC   |
|  |   |   |   | <b>Pipeline Initiation &amp; Start-up, Riser Installation (as applicable)</b>   |
| 6  | M   | R | P | Ensure documentation, drawings and procedures including lay analysis, procedure for buckle detector plate insertion, procedure for repair and recovery for dry and wet buckled pipeline etc. are latest Revision approved by ONGC |
| 7  | M   | R | P | Ensure Pull heads are tested and have full records  |
| 8  | M   | M | P | Ensure availability of line pipes with require wall thickness, grade and concrete coating thickness   |
| 9  | M   | M | P | Ensure availability of required type of Anode installed pipe  |
| 10   | W   | W | P | Buckle detector gauge plate dimensional inspection  |
| 11   | R   | R | P | Ensure all records and reports are maintained for all activities for submission in As-built Dossier to ONGC   |
|  |   |   |   | <b>Welding</b>  |
| 12   | M   | M | P | Visual inspection of Pipes for damage in bevel, Anti-corrosion coating and Concrete coating   |
| 13   | R   | M | P | Pipe tally report verification with Pipe Number, Heat Number and Length   |
| 14   | R   | M | P | Check ovality of Pipe at ends   |
| 15   | R   | M | P | Pipe end caps shall only be removed immediately prior to bevelling activity. If delays occur between bevelling and line-up and welding then contractor shall replace the end caps.  |



|    |    |    |   |  |  |
|----|----|----|---|--|--|
| 16 | R  | M  | P |  | A rabbit brush is run through the pipe joint to check and clean the internal surface of the pipeline. Before being added to the line each pipe joint is cleaned by compressed air blowing and visually inspected to ensure that no loose debris has entered the line pipe before lifting for fit-up. |
| 17 | R  | R  | P |  | Ensure fit up of internal/external line clamps and availability and display at weld station of Approved Welding Procedure Specification (WPS)  |
| 18 | R  | R  | P |  | Ensure availability of Qualified Welders and their welder test certificates/reports at weld station  |
| 19 | R  | R  | P |  | Ensure availability of Welding consumables and their conformity certificates   |
| 20 | R  | M  | P |  | Ensure availability of Baking and Holding ovens for Low Hydrogen Electrodes  |
| 21 | R  | R  | P |  | Calibration for temperature of mother oven and Portable oven   |
| 22 | M  | M  | P |  | Maintain Electrode Baking log book   |
| 23 | M  | M  | P |  | Ensure availability of appropriate welding machines  |
| 24 | R  | R  | P |  | Ensure availability of ID cards for welders  |
| 25 | RW | RW | P |  | Fit-up Inspection as per the joint design in WPS   |
| 26 | RW | RW | P |  | Monitor welding variables as per approved WPS at each welding station at start of each shift   |
| 27 | RW | RW | P |  | Weld inspection for completed welds  |
| 28 | R  | M  | P |  | Ensure proper Weld number and Welder ID number written on the pipe adjacent to the weld  |
| 29 | R  | RW | P |  | Preparation of Weld Visual Inspection Report   |
| 30 | R  | R  | P |  | Ensure all records and reports are maintained for all activities for submission in As-built Dossier to ONGC  |
|    |    |    |   |  | <b>Non-Destructive Testing</b>   |
| 31 | R  | R  | P |  | Availability of Approved NDT Procedures  |
| 32 | R  | R  | P |  | Availability of qualified NDT personnel and display of their valid proficiency certificates  |
| 33 | R  | R  | P |  | Calibration certificates of NDT Equipments   |
| 34 | R  | R  | P |  | NDT Procedure Qualification Reports, as applicable   |
| 35 | RW | RW | P |  | Perform NDT as per Approved Procedures   |
| 36 | R  | R  | P |  | Ensure Proper Safety procedure during radiation  |
| 37 | R  | R  | P |  | Interpretation of Results by ASNT-NDT-Level II Personnel   |
| 38 | R  | R  | P |  | NDT Reports with result  |
| 39 | R  | R  | P |  | Ensure all records and reports are maintained for all activities for submission in As-built Dossier to ONGC  |
|    |    |    |   |  | <b>Repair Welding</b>  |
| 40 | R  | R  | P |  | Availability of Approved Repair Welding Procedures   |



|  |    |    |   |  |
|--|----|----|---|--|
| 41   | M  | M  | P | Ensure Qualified Welders for Repair and display of their test certificates   |
| 42   | R  | M  | P | Marking of Repair area on Weld   |
| 43   | M  | M  | P | Carbon Arc Gouging and Grinding Repair Area  |
| 44   | R  | W  | P | Ensure complete removal of defect by Visual and MPI  |
| 45   | M  | M  | P | Monitor Repair Welding variables once per shift  |
| 46   | RW | RW | P | Visual Inspection after Repair Welding   |
| 47   | R  | R  | P | Preparation of Weld Repair report  |
| 48   | R  | R  | P | NDT of repaired area as applicable for Original Weld   |
| 49   | R  | R  | P | Ensure all records and reports are maintained for all activities for submission in As-built Dossier to ONGC                      |
| <b>Field Joint Coating- Heat Shrink Sleeve</b> |    |    |   |  |
| 50   | R  | R  | P | Availability of Approved Field Joint Coating Procedure   |
| 51   | R  | M  | P | Ensure joint is cleaned to require Grade as per the Procedure requirement. Ensure no burr or sharp cuts are made on Pipe surface |
| 52   | RW | RW | P | Visual Inspection of Heat Shrink Sleeve  |
| 53   | R  | R  | P | Review Conformity of Batch Test certificates of Heat Shrink Sleeves  |
| 54   | W  | W  | P | PQT of Heat Shrink Sleeve  |
| 55   | R  | M  | P | Check pre-heating of joints is even and meets manufacturer's requirement   |
| 56   | RW | RW | P | Visual Inspection after Heat Shrink Sleeve application   |
| 57   | RW | RW | P | Peel Test shall be done at every 100 joints  |
| 58   | RW | RW | P | Damages shall be repaired and inspected as per approved Procedure  |
| 59   | R  | M  | P | Thickness measurement (One time per shift)   |
| 60   | M  | M  | P | Calibration of Holiday Detector  |
| 61   | RW | RW | P | Holiday testing of Joint as per the approved procedure   |
| 62   | R  | R  | P | Ensure all records and reports are maintained for all activities for submission in As-built Dossier to ONGC                      |
| <b>HDPU Foam Infill</b>                        |    |    |   |  |
| 63   | R  | R  | P | Availability of Approved HDPU Foam infill procedure  |
| 64   | R  | R  | P | Review Conformity of Batch Test certificates of HDPU Foam  |
| 65   | W  | W  | P | PQT of HDPU Foam infill with dry density, saturated density and Compressive Strength test  |
| 66   | RW | RW | P | Dry Density check for each batch on board  |
| 67   | RW | RW | P | Visual Inspection of applied Foam infill   |
| 68   | R  | R  | P | Ensure all Instruments are calibrated  |
| 69   | R  | R  | P | Ensure all records and reports are maintained for all activities for submission in As-built Dossier to ONGC                      |



| <b>Pipe lay Monitoring</b>               |   |   |   |  |
|--|---|---|---|--|
| 70                                       | M | M | P | Pipeline laying records to show that pipeline is positioned within tolerances specified  |
| 71                                       | R | R | P | Pipeline tension records being maintained  |
| 72                                       | R | R | P | Load cell calibration reading monitoring and buckle detection  |
| 73                                       | R | R | P | Required line pipes with Anodes are installed as per the Approved Alignment Drawings   |
| 74                                       | R | R | P | Generate Pipe Book Record with all relevant details  |
| 75                                       | R | R | P | Ensure all records and reports are maintained for all activities for submission in As-built Dossier to ONGC  |
| <b>Pipeline Completion and Lay down</b>  |   |   |   |  |
| 76                                       | W | W | P | Recovery of Buckle detector  |
| 77                                       | W | W | P | Buckle detector gauge plate Inspection and Photograph for records  |
| 78                                       | R | R | P | Lay down Head Inspection Report  |
| 79                                       | R | R | P | Ensure all records and reports are maintained for all activities for submission in As-built Dossier to ONGC  |
| <b>Pipeline Abandonment and Recovery</b> |   |   |   |  |
| 80                                       | R | R | P | Pipeline A&R winch has been tested and approved  |
| 81                                       | W | W | P | Ensure all aspects of operations are carried out as per the approved procedure   |
| 82                                       | R | R | P | Ensure all records and reports are maintained for all activities for submission in As-built Dossier to ONGC  |
| <b>Additional for Risers</b>             |   |   |   |  |
| 83                                       | M | R | P | Ensure documentation, drawings and procedures for riser installation including davit lift analysis etc. are latest Revision approved by ONGC.<br>Ensure visual inspection of Monel sheathed riser pipe and NDT and pressure testing records and reports of monel joints. |
| 84                                       | W | W | P | Ensure risers are supported by hanger flanges and guided by non-frictional riser clamps. All bolting on the riser clamps are fully tightened double nuts on each end of the studs with Xylan coating   |
| 85                                       | W | W | P | Ensure electrical continuity for cathodic protection of the clamps shall be provided between jacket and clamps   |
| 86                                       | W | W | P | Removal of knee brace after riser installation is completed and clamps are tightened.  |
| 87                                       | R | R | P | Ensure all records and reports are maintained for all activities for submission in As-built Dossier to ONGC  |
| <b>Crossing Installation</b>             |   |   |   |  |
| 88                                       | M | R | P | Ensure documentation, drawings and procedures for crossing installation are latest Revision approved by ONGC   |
| 89                                       | M | M | P | Ensure availability of grout bags, cement etc. as per the design requirement and specification. Ensure Monitoring of grout density and grout compressive strength as per Company Specifications.   |



|                             |   |   |   |   |
|-----------------------------|---|---|---|---|
| 90                          | W | R | P | Ensure the length of the free span between the two supports shall not exceed the limits as mentioned in the Company approved documents  |
| 91                          | W | W | P | Detailed inspection of all the pipeline crossings 12 hours after completion of the installation. Ensure that there is no gap between pipe bottom and grout support to transfer loads coming on to pipeline to grout supports. |
| 92                          | R | R | P | Ensure all records and reports are maintained for all activities for submission in As-built Dossier to ONGC   |
| <b>Free Span Correction</b> |   |   |   |   |
| 93                          | H | R | P | Review of survey after completion of the pipeline installation to assess the span requiring correction  |
| 94                          | M | M | P | Ensure availability of grout bags, cement etc. as per the requirement of specification  |
| 95                          | W | R | P | Ensure the length of the free span between the two supports shall not exceed the limits as mentioned in the Company approved documents.   |
| 96                          | W | W | P | Detailed inspection of free span correction after completion of the installation. Ensure that there is no gap between pipe bottom and grout support to transfer loads coming on to pipeline to grout supports.                |
| 97                          | R | R | P | Ensure all records and reports are maintained for all activities for submission in As-built Dossier to ONGC   |

**P-Perform; M- Monitor; R- Review; W-Witness; RW-Random Witness; H-Hold**

**Note: The Activities listed above are not exhaustive. Inspection of other activities shall be carried out as per requirement of the FS & Design Criteria.**



|  |   |    |   |  |
|--|---|----|---|--|
| <b>Item: Pipeline Pigging and Hydrotesting</b> |   |    |   | <b>INSPECTION CATEGORY: A</b>  |
| <b>ONGC FUNCTIONAL SPEC: 2022</b>              |   |    |   |  |
| Activity No                                    | 1. Inspection by ONGC or ONGC Appointed Certification Agency (CA) |    |   |  |
|  | 2. Inspection by ONGC's inspection agency (TPI)                   |    |   |  |
|  | 3. Inspection by Contractor/ Sub-Contractor                       |    |   |  |
|  | Stages of Inspection  |    |   |  |
| <b>Prior to Commencement of Work</b>           |   |    |   |  |
| 1  | R   | R  | P | Approved Project Drawings and Documents, as applicable are available   |
| 2  | R   | R  | P | Ensure Completion certificates related to Segment e.g. Pipeline, Riser, Crossing, Free-Span are available  |
| 3  | R   | R  | P | Approved Procedure for Pigging & Hydrotesting is available   |
| 4  | RW  | RW | P | Calibration and Certification of all test equipment are available  |
| 5  | RW  | RW | P | Ensure all safety procedures are in place  |
| 6  | RW  | RW | P | Testing of Sea water at Laboratory for analysis prior to Flooding & Hydrotesting   |
| 7  | R   | R  | P | Recommendation from Chemical manufacturer for proportion of chemical mixture for Oxygen scavenger, Bactericide, Corrosion inhibitor                  |
| 8  | RW  | RW | P | Equipment & Instruments set up according to battery limit of subsea pipeline for Pigging and Hydrotesting  |
| 9  | R   | R  | P | Ensure all records and reports are maintained for all activities for submission in As-built Dossier to ONGC  |
| <b>Flooding, Cleaning and Gauging</b>          |   |    |   |  |
| 10   | RW  | RW | P | Launch pigs as per sequence along with filtered seawater equivalent to 250m length of pipe behind each pig   |
| 11   | W   | W  | P | Inspect Magnetic attachment on Cleaning Pig. Maintain photographic record of the debris received after cleaning                                      |
| 12   | W   | W  | P | Ensure gauge plate dimension is as per specification and approved procedure  |
| 13   | W   | W  | P | Ensure witness of gauge plate fitting and gauge plate signed by client before assembling gauge pig. Make records including photograph of Gauge plate |
| 14   | RW  | RW | P | After launching gauge pig, monitor filling water, chemical injection dosage and record all parameters  |
| 15   | W   | W  | P | Record details of Chemicals (Oxygen scavenger, Bactericide, Corrosion inhibitor) like Manufacturer, Trade name, Composition, Dosage, data sheet      |
| 16   | W   | W  | P | Recover pigs and gauge plate shall be inspected. Make records including photograph of Gauge plate  |
| 17   | R   | R  | P | Ensure all records and reports are maintained for all activities for submission in As-built Dossier to ONGC  |



| <b>Hydrotesting</b> |    |    |   |   |
|---------------------|----|----|---|---|
| 18                  | H  | H  | P | Hydrotest water shall be injected with Oxygen scavenger, Bactericide, Corrosion inhibitor and dye.  |
| 19                  | W  | W  | P | Record details of Chemicals (Oxygen scavenger, Bactericide, Corrosion inhibitor) like Manufacturer, Trade name, Composition, Dosage, data sheet |
| 20                  | RW | RW | P | Check air content, pressurization, stabilization as per specifications and approved procedures.   |
| 21                  | RW | W  | P | Hold 24 hours at Hydrotest Pressure   |
| 22                  | RW | RW | P | During the hold period, the pressure and the water temperature shall be recorded every one hour   |
| 23                  | RW | W  | P | Depressurization as per specifications and approved procedures.   |
| 24                  | W  | W  | P | Recording of all parameters during Hydrotesting   |
| 25                  | R  | R  | P | Ensure all records and reports are maintained for all activities for submission in As-built Dossier to ONGC                                     |

**P-Perform; M- Monitor; R- Review; W-Witness; RW-Random Witness; H-Hold**

**Note: The Activities listed above are not exhaustive. Inspection of other activities shall be carried out as per requirement of the FS & Design Criteria.**

**Signature Not Verified**

Digitally signed by VIPIN KUMAR GUPTA  
Date: 2024.03.28 14:53:07 IST  
Location: PSUs of Ministry of Defence-  
DEFPSU

|                            |                                   |                 |                |                          |
|----------------------------|-----------------------------------|-----------------|----------------|--------------------------|
| FORMAT No.<br>ODS/SOF/004A | Ref. PROCEDURE No.<br>ODS/SOP/023 | ISSUE No.<br>01 | REV. No.<br>00 | REV. DATE:<br>08.03.2016 |
|----------------------------|-----------------------------------|-----------------|----------------|--------------------------|