



निविदा पूछताछ
TENDER ENQUIRY

[सीमित निविदा]
[LIMITED TENDER]

माझगांव डॉक शिपबिल्डर्स लिमिटेड
(भारत सरकार का उपक्रम)
MAZAGON DOCK SHIPBUILDERS LIMITED
(Formerly known as Mazagon Dock Limited)
(A Govt. of India Undertaking)
CIN: L35100MH1934GOI002079
Dockyard Road, Mumbai 400 010
Website- www.mazagondock.in
Certified - ISO 9001: 2008 for Shipbuilding Division
GST ID : 27AAACM8029J1ZA

निविदा सं./Tender No	1700000539	विभाग/Department	MPV COMMERCIAL
क्रय अधिकारी/Purchase Exec.	A.B.KAWADE	क्रय अधिकारी/Purchase Exec.	A.B.KAWADE
सेवा में /To		दूरभाष सं./Telephone No	23762732
		फैक्स सं./Fax No	23744709
		ई-मेल/E-Mail	abkawade@mazdock.com
दूरभाष सं./Telephone		निविदा सं./Tender No	1700000539
फैक्स सं./Fax		निविदा तिथि/ Tender Date	15.03.2024
ई-मेल/E-Mail		निविदा बंद की तिथि/Tender Closing Date	21.03.2024
		निविदा बंद होने का समय/Tender Closing Time	12:00:00
		आरएफक्यू सं./RFQ No	2230000030

निविदा शुल्क/Tender Fee	रु/Rs	0.00
बयाना राशि/EMD Amount	रु/Rs	0.00
पुर्व बिड बैठक तिथि और समय/Pre Bid Meeting Date & Time		,00:00:00
निविदा खोलने की तिथि और समय/Tender Opening Date & Time		22.03.2024,14:00:00
प्रस्ताव वैधता तिथि है/Offer should be valid up to		
सुरक्षा जमा/Security Deposit		0.00 %आदेश मूल्य का/PO value
वरीय बैंक जमानत /Perf. Bank Guarantee		5.00 %आदेश मूल्य का/PO value

(आगे के विवरण हेतु कृपया सम्बंधित नियम शर्तों को पढ़ें । सुनिश्चित करें कि कोटेशन और संबंधित पत्राचार के लिए विभाग का नाम, क्रय अधिकारी का नाम, निविदा संख्या, बंद होने का समय एवं तिथि एवं आरएफक्यू सं. अपने कोटेशनमें लिखें ।
Kindly read and refer relevant terms & conditions for further details. Do ensure to Quote Department Name, Purchase Executive 's Name , Tender Number, closing date & time and RFQ Number in your Quotation & related correspondence)

प्रिय महोदय/महोदया
Dear Sir / Madam ,

विषय /SUB:- SUPPLY OF WINDLASS AND MOORING WINCHES FOR MPV PROJECT

माझगाँव डॉक शिपबिल्डर्स लिमिटेड प्रतिष्ठित/संभावित आपूर्तिकर्ताओं से निम्न हेतु, प्रतियोगितात्मक दो बोली प्रणाली में (भाग - I तकनिकी - वाणिज्य बोली एवं भाग II मूल्य बोली) बोली आमंत्रित करती है।
Mazagon Dock Shipbuilders Limited (MDL) invites Competitive – Bid from reputed Supplier for the following in TWO BID system (Part - I Techno - Commercial Bid & Part - II Price Bid).

क्र सं. SL.No.	सामग्री / सेवा विवरण Material / Service Details	मात्रा / इकाई Quantity / unit	आपूर्ति तिथि Delivery Date
00100	सामग्री सं./ Material Number :- 15000000000074497 Windlass for MPV	2 Number	31.03.2025
	सामग्री वर्णन/Material Description :windlass/mooring winches for MPV		
00200	सामग्री सं./ Material Number :- 15000000000074498	2 Number	31.03.2025

निविदा सं./ Tender No:- 1700000539		निविदा तिथि/ Tender Date:- 15.03.2024		आरएफक्यू सं./RFQ No:- 2230000030	
क्र सं. SL.No.	सामग्री / सेवा विवरण Material / Service Details	मात्रा / इकाई Quantity / unit	आपूर्ति तिथि Delivery Date		
Mooring Winch for MPV सामग्री वर्णन/Material Description :Mooring Winch for MPV					
00300	सामग्री सं./ Material Number :- 150000000000074528 DOCUMENTS/DRGS CERT- WINDLASS/MOORING WI	1 SET	31.03.2025		
सामग्री वर्णन/Material Description :DOCUMENTS, DRAWINGS, CERTIFICATES FOR WINDLASS/MOORING WINCHES					
00400	सामग्री सं./ Material Number :- 150000000000074529 OBS FOR ONE YEAR	1 SET	31.03.2025		
00500	INSTALLATION OF THE WINDLASS/MOORING WIN	1 Activity unit	31.03.2025		
The Line item 00500 covers the following services					
000000001 0	सेवा सं./Service Number :- संक्षिप्त वर्णन/Short Description :- INSTALLATION OF THE WINDLASS/MOORING WIN	1 Activity unit			
सेवा विवरण/Service Details :- The supplier is required to submit the specifications and technical documentation for installation of the windlass/mooring winches.Shipyards will carry out installation as per this document. The supplier must depute technical experts to supervise and guide the shipyards to carry out the initial test and trails, HATs and SATs.					
00600	सामग्री सं./ Material Number :- 150000000000074497 Windlass for MPV	2 Number	30.05.2025		
सामग्री वर्णन/Material Description :windlass/mooring winches for MPV					
00700	सामग्री सं./ Material Number :- 150000000000074498 Mooring Winch for MPV	2 Number	30.05.2025		
सामग्री वर्णन/Material Description :Mooring Winch for MPV					
00800	सामग्री सं./ Material Number :- 150000000000074528 DOCUMENTS/DRGS CERT- WINDLASS/MOORING WI	1 SET	30.05.2025		
सामग्री वर्णन/Material Description :DOCUMENTS, DRAWINGS, CERTIFICATES FOR WINDLASS/MOORING WINCHES					
00900	सामग्री सं./ Material Number :- 150000000000074529 OBS FOR ONE YEAR	1 SET	30.05.2025		
01000	INSTALLATION OF THE WINDLASS/MOORING WIN	1 Activity unit	30.05.2025		
The Line item 01000 covers the following services					
000000001 0	सेवा सं./Service Number :- संक्षिप्त वर्णन/Short Description :- INSTALLATION OF THE WINDLASS/MOORING WIN	1 Activity unit			

क्र सं. SL.No.	सामग्री / सेवा विवरण Material / Service Details	मात्रा / इकाई Quantity / unit	आपूर्ति तिथि Delivery Date
	सेवा विवरण/Service Details :- The supplier is required to submit the specifications and technical documentation for installation of the windlass/mooring winches. Shipyards will carry out installation as per this document. The supplier must depute technical experts to supervise and guide the shipyards to carry out the initial test and trails,HATs and SATs.		
01100	सामग्री सं./ Material Number :- 15000000000074497 Windlass for MPV सामग्री वर्णन/Material Description :windlass/mooring winches for MPV	2 Number	31.07.2025
01200	सामग्री सं./ Material Number :- 15000000000074498 Mooring Winch for MPV सामग्री वर्णन/Material Description :Mooring Winch for MPV	2 Number	31.07.2025
01300	सामग्री सं./ Material Number :- 15000000000074528 DOCUMENTS/DRGS CERT- WINDLASS/MOORING WI सामग्री वर्णन/Material Description :DOCUMENTS, DRAWINGS, CERTIFICATES FOR WINDLASS/MOORING WINCHES	1 SET	31.07.2025
01400	सामग्री सं./ Material Number :- 15000000000074529 OBS FOR ONE YEAR	1 SET	31.07.2025
01500	INSTALLATION OF THE WINDLASS/MOORING WIN The Line item 01500 covers the following services	1 Activity unit	31.07.2025
000000001 0	सेवा सं./Service Number :- संक्षिप्त वर्णन/Short Description :- INSTALLATION OF THE WINDLASS/MOORING WIN सेवा विवरण/Service Details :- The supplier is required to submit the specifications and technical documentation for installation of the windlass/mooring winches. Shipyards will carry out installation as per this document. The supplier must depute technical experts to supervise and guide the shipyards to carry out the initial test and trails,HATs and SATs.	1 Activity unit	
01600	सामग्री सं./ Material Number :- 15000000000074497 Windlass for MPV सामग्री वर्णन/Material Description :windlass/mooring winches for MPV	2 Number	30.09.2025
01700	सामग्री सं./ Material Number :- 15000000000074498 Mooring Winch for MPV सामग्री वर्णन/Material Description :Mooring Winch for MPV	2 Number	30.09.2025
01800	सामग्री सं./ Material Number :- 15000000000074528 DOCUMENTS/DRGS CERT- WINDLASS/MOORING WI सामग्री वर्णन/Material Description :DOCUMENTS, DRAWINGS, CERTIFICATES FOR	1 SET	30.09.2025

क्र सं. SL.No.	सामग्री / सेवा विवरण Material / Service Details	मात्रा / इकाई Quantity / unit	आपूर्ति तिथि Delivery Date
WINDLASS/MOORING WINCHES			
01900	सामग्री सं./ Material Number :- 15000000000074529 OBS FOR ONE YEAR	1 SET	30.09.2025
02000	INSTALLATION OF THE WINDLASS/MOORING WIN	1 Activity unit	30.09.2025
The Line item 02000 covers the following services			
000000001 0	सेवा सं./Service Number :- संक्षिप्त वर्णन/Short Description :- INSTALLATION OF THE WINDLASS/MOORING WIN सेवा विवरण/Service Details :- The supplier is required to submit the specifications and technical documentation for installation of the windlass/mooring winches. Shipyards will carry out installation as per this document. The supplier must depute technical experts to supervise and guide the shipyards to carry out the initial test and trails,HATs and SATs.	1 Activity unit	
02100	सामग्री सं./ Material Number :- 15000000000074497 Windlass for MPV सामग्री वर्णन/Material Description :windlass/mooring winches for MPV	2 Number	28.11.2025
02200	सामग्री सं./ Material Number :- 15000000000074498 Mooring Winch for MPV सामग्री वर्णन/Material Description :Mooring Winch for MPV	2 Number	28.11.2025
02300	सामग्री सं./ Material Number :- 15000000000074528 DOCUMENTS/DRGS CERT- WINDLASS/MOORING WI सामग्री वर्णन/Material Description :DOCUMENTS, DRAWINGS, CERTIFICATES FOR WINDLASS/MOORING WINCHES	1 SET	28.11.2025
02400	सामग्री सं./ Material Number :- 15000000000074529 OBS FOR ONE YEAR	1 SET	28.11.2025
02500	INSTALLATION OF THE WINDLASS/MOORING WIN	1 Activity unit	28.11.2025
The Line item 02500 covers the following services			
000000001 0	सेवा सं./Service Number :- संक्षिप्त वर्णन/Short Description :- INSTALLATION OF THE WINDLASS/MOORING WIN सेवा विवरण/Service Details :- The supplier is required to submit the specifications and technical documentation for installation of the windlass/mooring winches. Shipyards will carry out installation as per this document. The supplier must depute technical experts to supervise and guide the shipyards to carry out the initial test and trails,HATs and SATs.	1 Activity unit	

क्र सं. SL.No.	सामग्री / सेवा विवरण Material / Service Details	मात्रा / इकाई Quantity / unit	आपूर्ति तिथि Delivery Date
02600	सामग्री सं./ Material Number :- 15000000000074497 Windlass for MPV सामग्री वर्णन/Material Description :windlass/mooring winches for MPV	2 Number	30.01.2026
02700	सामग्री सं./ Material Number :- 15000000000074498 Mooring Winch for MPV सामग्री वर्णन/Material Description :Mooring Winch for MPV	2 Number	30.01.2026
02800	सामग्री सं./ Material Number :- 15000000000074528 DOCUMENTS/DRGS CERT- WINDLASS/MOORING WI सामग्री वर्णन/Material Description :DOCUMENTS, DRAWINGS, CERTIFICATES FOR WINDLASS/MOORING WINCHES	1 SET	30.01.2026
02900	सामग्री सं./ Material Number :- 15000000000074529 OBS FOR ONE YEAR	1 SET	30.01.2026
03000	INSTALLATION OF THE WINDLASS/MOORING WIN The Line item 03000 covers the following services	1 Activity unit	30.01.2026
00000001 0	सेवा सं./Service Number :- संक्षिप्त वर्णन/Short Description :- INSTALLATION OF THE WINDLASS/MOORING WIN सेवा विवरण/Service Details :- The supplier is required to submit the specifications and technical documentation for installation of the windlass/mooring winches. Shipyards will carry out installation as per this document. The supplier must depute technical experts to supervise and guide the shipyards to carry out the initial test and trails,HATs and SATs.	1 Activity unit	
03100	सामग्री सं./ Material Number :- 15000000000074497 Windlass for MPV सामग्री वर्णन/Material Description :windlass/mooring winches for MPV(item is optional)	2 Number	30.07.2027
03200	सामग्री सं./ Material Number :- 15000000000074498 Mooring Winch for MPV सामग्री वर्णन/Material Description :Mooring Winch for MPV(item is optional)	2 Number	30.07.2027
03300	सामग्री सं./ Material Number :- 15000000000074528 DOCUMENTS/DRGS CERT- WINDLASS/MOORING WI सामग्री वर्णन/Material Description :DOCUMENTS, DRAWINGS, CERTIFICATES FOR WINDLASS/MOORING WINCHES(item is optional)	1 SET	30.07.2027
03400	सामग्री सं./ Material Number :- 15000000000074529 OBS FOR ONE YEAR सामग्री वर्णन/Material Description :OBS FOR ONE YEAR(item is optional)	1 SET	30.07.2027
03500	INSTALLATION OF THE WINDLASS/MOORING	1 Activity unit	30.07.2027

क्र सं. SL.No.	सामग्री / सेवा विवरण Material / Service Details	मात्रा / इकाई Quantity / unit	आपूर्ति तिथि Delivery Date
WIN			
The Line item 03500 covers the following services			
000000001 0	सेवा सं./Service Number :- संक्षिप्त वर्णन/Short Description :- INSTALLATION OF THE WINDLASS/MOORING WIN सेवा विवरण/Service Details :- The supplier is required to submit the specifications and technical documentation for installation of the windlass/mooring winches.Shipyards will carry out installation as per this document. The supplier must depute technical experts to supervise and guide the shipyards to carry out the initial test and trails, HATs and SATs.	1 Activity unit	
03600	सामग्री सं./ Material Number :- 150000000000074497 Windlass for MPV सामग्री वर्णन/Material Description :windlass/mooring winches for MPV(item is optional)	2 Number	30.07.2027
03700	सामग्री सं./ Material Number :- 150000000000074498 Mooring Winch for MPV सामग्री वर्णन/Material Description :Mooring Winch for MPV(item is optional)	2 Number	30.07.2027
03800	सामग्री सं./ Material Number :- 150000000000074528 DOCUMENTS/DRGS CERT- WINDLASS/MOORING WI सामग्री वर्णन/Material Description :DOCUMENTS, DRAWINGS, CERTIFICATES FOR WINDLASS/MOORING WINCHES(item is optional)	1 SET	30.07.2027
03900	सामग्री सं./ Material Number :- 150000000000074529 OBS FOR ONE YEAR सामग्री वर्णन/Material Description :OBS FOR ONE YEAR(item is optional)	1 SET	30.07.2027
04000	INSTALLATION OF THE WINDLASS/MOORING WIN The Line item 04000 covers the following services	1 Activity unit	30.07.2027
000000001 0	सेवा सं./Service Number :- संक्षिप्त वर्णन/Short Description :- INSTALLATION OF THE WINDLASS/MOORING WIN सेवा विवरण/Service Details :- The supplier is required to submit the specifications and technical documentation for installation of the windlass/mooring winches.Shipyards will carry out installation as per this document. The supplier must depute technical experts to supervise and guide the shipyards to carry out the initial test and trails, HATs and SATs.	1 Activity unit	
04100	सामग्री सं./ Material Number :- 150000000000074497 Windlass for MPV सामग्री वर्णन/Material Description :windlass/mooring winches for MPV(item is optional)	2 Number	30.07.2027
04200	सामग्री सं./ Material Number :- 150000000000074498 Mooring Winch for MPV	2 Number	30.07.2027

क्र सं. SL.No.	सामग्री / सेवा विवरण Material / Service Details	मात्रा / इकाई Quantity / unit	आपूर्ति तिथि Delivery Date
सामग्री वर्णन/Material Description :Mooring Winch for MPV(item is optional)			
04300	सामग्री सं./ Material Number :- 150000000000074528 DOCUMENTS/DRGS CERT- WINDLASS/MOORING WI	1 SET	30.07.2027
सामग्री वर्णन/Material Description :DOCUMENTS, DRAWINGS, CERTIFICATES FOR WINDLASS/MOORING WINCHES(item is optional)			
04400	सामग्री सं./ Material Number :- 150000000000074529 OBS FOR ONE YEAR	1 SET	30.07.2027
सामग्री वर्णन/Material Description :OBS FOR ONE YEAR(item is optional)			
04500	INSTALLATION OF THE WINDLASS/MOORING WIN	1 Activity unit	30.07.2027
The Line item 04500 covers the following services			
000000001 0	सेवा सं./Service Number :- संक्षिप्त वर्णन/Short Description :- INSTALLATION OF THE WINDLASS/MOORING WIN	1 Activity unit	
सेवा विवरण/Service Details :- The supplier is required to submit the specifications and technical documentation for installation of the windlass/mooring winches.Shipyards will carry out installation as per this document. The supplier must depute technical experts to supervise and guide the shipyards to carry out the initial test and trails, HATs and SATs.			
04600	सामग्री सं./ Material Number :- 150000000000074497 Windlass for MPV	2 Number	30.07.2027
सामग्री वर्णन/Material Description :windlass/mooring winches for MPV(item is optional)			
04700	सामग्री सं./ Material Number :- 150000000000074498 Mooring Winch for MPV	2 Number	30.07.2027
सामग्री वर्णन/Material Description :Mooring Winch for MPV(item is optional)			
04800	सामग्री सं./ Material Number :- 150000000000074528 DOCUMENTS/DRGS CERT- WINDLASS/MOORING WI	1 SET	30.07.2027
सामग्री वर्णन/Material Description :DOCUMENTS, DRAWINGS, CERTIFICATES FOR WINDLASS/MOORING WINCHES(item is optional)			
04900	सामग्री सं./ Material Number :- 150000000000074529 OBS FOR ONE YEAR	1 SET	30.07.2027
सामग्री वर्णन/Material Description :OBS FOR ONE YEAR(item is optional)			
05000	INSTALLATION OF THE WINDLASS/MOORING WIN	1 Activity unit	30.07.2027
The Line item 05000 covers the following services			
000000001 0	सेवा सं./Service Number :-	1 Activity unit	

क्र सं. SL.No.	सामग्री / सेवा विवरण Material / Service Details	मात्रा / इकाई Quantity / unit	आपूर्ति तिथि Delivery Date
<p>संक्षिप्त वर्णन/Short Description :- INSTALLATION OF THE WINDLASS/MOORING WIN</p> <p>सेवा विवरण/Service Details :- The supplier is required to submit the specifications and technical documentation for installation of the windlass/mooring winches. Shipyards will carry out installation as per this document. The supplier must depute technical experts to supervise and guide the shipyards to carry out the initial test and trails, HATs and SATs.</p>			

नियम और शर्तें : भाग ए में लिखी हुई और इतर संलग्नपत्रे इस निविदा एक अभिन्न अंग हैं | हमें आशा है की, हमें प्रतियोगित्मिक और उचित प्रस्ताव इस निविदा के लिए प्राप्त होगा |

Terms & Conditions as indicated in Part A of this tender and other enclosures / annexures form an integral part of this tender document. We look forward to receive your most competitive and reasonable offer against this Tender.

माझगाँव डॉक शिपबिल्डर्स लिमिटेड के लिए /For Mazagon Dock Shipbuilders Ltd

Tender No. 170000539(Nominated Limited Global Tender Enquiry)



Tender Enquiry

Enclosure to Tender Enquiry: Terms and Conditions (Section I & II)
Item: Tender For Supply Of Windlass and Mooring Winches For Project
7500 DWT.

Project: Multi-Purpose Dry Cargo Vessel(MPV)

Section I - Notice Inviting Tender (NIT)

- (i) Notice Inviting Tender (NIT): Mazagon Dock Shipbuilders Limited (MDL), Mumbai is India's leading Shipbuilding Company with ISO 9001:2015 accreditation. Mazagon Dock Shipbuilders Limited, invites offers in two bid system i.e. Part-I (Techno Commercial Bid) and Part-II (Price Bid) from Indian/Foreign bidders through online bidding via MDL e-procurement portal (<https://eprocuremdl.nic.in>) for Item /Services.
- (ii) **The Tender Document:**
- (i) **Bidders must read the complete 'Tender Document'**. Kindly visit MDL website Link : <https://mazagondock.in/English/pages/Tenders> under tab Ship Building(SB)/MPV Project for formats as detailed in enclosure.
- (ii) Bids must be uploaded till the deadline for submission of bids. Request for extension, if at all to be made, shall be forwarded at least 3 working days in advance to the tender closing date / time (excluding tender closing date) with proper reasoning. **However, the extension would be granted by MDL on merit of the case at MDL discretion and would be binding on all bidders.**
- (iii) **Eligibility Criteria for Participation in this Tender:** Subject to provisions in the Tender Document, participation in this Tender Process is limited to nominated bidders who fulfil the 'Eligibility' and Pre-Qualification criteria. Bidder shall be required to declare fulfilment of Eligibility Criteria.
- (iv) Incase manufacturer has submitted the bid, then bids of its authorized dealer will not be considered.
- (v) **Submission of Bids:** No manual Bids shall be made available or accepted for submission (except for originals of scanned copies as mentioned in tender). Bidder must comply with the conditions of the eProcurement portal, including registration, compatible Digital Signature Certificate (DSC) etc. In the case of downloaded documents, Bidder must not make any changes to the contents of the documents while uploading, except for filling in the required information.
- (vi) **Disclaimers and Rights of MDL:** The issue of the Tender Document does not imply that MDL is bound to select bid(s), and it reserves the right without assigning any reason to
- reject any or all of the Bids, or
 - cancel the tender process; or
 - abandon the procurement of the Goods/Services in partial or full; or
 - issue another tender for identical or similar Goods/Services.

Note: Please refer to appended complete Tender Document for further details.

Tender Inviting Authority

Tender No. 170000539(Nominated Limited Global Tender Enquiry)

Section II - Tender Enquiry Form (TEF)

1. **Description & Scope of Supply / Work:** As per Tender & TSP NO. DR/F/MPV/2028

Note: Optional Requirement:

a. From Sr. No. 3100 to 5000 of BOQ (Price Bid) are optional requirement for placement of order by MDL at later date latest by Dec 2026.

b. In case MDL intends to buy 04 more ship sets (i.e. as per sr. no. 3100 to 5000 of BoQ) (2 nos. + 2 nos.) of this scope, bidders shall quote their price for additional shipsets (04 nos.) with price validity up to Dec 2026 in the price sheet attached with the tender.

c. Bidder should note that quote for additional 4 shipsets will be considered for ranking purpose.

d. Bidders shall not claim for this requirement in case this clause is not being exercised.

e. Placement of order for additional 4 shipsets (2 set + 2Sets) will be at MDL discretions.

2. **Validity Period of Offer:**

(a) Bid / Offer shall have the validity period of **180 days for first six shipsets** from the tender closing date and **for additional shipsets (04 nos.) price validity up to Dec 26.**

(b) MDL may request the bidders to extend the validity period for a specified additional period. A bidder may agree to or reject the request. A bidder who has agreed to MDL's request for extension of bid validity, in no case, he shall be permitted to modify his bid. In case techno-commercially accepted bidder/s does not agree to extend the offer validity, the offers of all techno-commercially accepted bidder/s including the bidder who has not agreed to extend their offer validity shall be opened and proceed further with valid bids. However, offer of the bidder(s) who have not agreed to extend their offer validity shall not be considered for L1 evaluation purpose.

3. **Delivery Period:**

Delivery timelines shall be as per tender date OR as follows with respect to PO date whichever is later.

Yard No.	Equipment delivery date
21001	PO date + 06 months
21002	PO date + 06 months
21003	PO date + 06 months
21004	PO date + 09 months
21005	PO date + 09 months
21006	PO date + 09 months
21007	PO date + 09 months
21008	PO date + 09 months
21009	PO date + 09 months
21010	PO date + 09 months

For services, The given schedule is tentative, the exact schedule will be communicated 15 days in advance before respective activity.

4. **Submission of Offer in Two Bid System:** Offer must be submitted in two parts as follows:

a) **Part I (Techno Commercial Bid):** The bidder shall ensure submission of techno-commercial offer as per tender terms.

Note: In any case, prices are not to be mentioned in Part-I bid.

Tender No. 170000539(Nominated Limited Global Tender Enquiry)

- b) **Part-II (Price Bid):** Prices for each of the listed items has to be uploaded strictly in the prescribed format provided in the e-procurement portal. Bids received other than this given format will be rejected.

Note:

- If, in the price structure quoted for the required goods, there is discrepancy between the unit price and total price (which is obtained by multiplying the unit price by the quantity), the unit price shall prevail and the total price corrected accordingly;
- If there is a discrepancy between words and figures, the amount in words shall prevail.
- Bidder must quote for all line items being inseparable line items.

5. Bid Rejection Criteria:

- (a) **Categorical rejection criteria:** Any Bids received other than through e-portal (in case of e-tender) shall be summarily rejected.
- (b) **Liabe rejection criteria:** Non-compliance/non-acceptance to any of the terms and conditions of the tender shall render the bid liable for rejection.

6. Performance Security Bank Guarantee(PSBG):

- (i) Separate Performance Security(PS) for an amount equal to 5% of each order value (excluding taxes, duties) payable in currency of purchase order shall be submitted within 25 days after notification of the award of contract and it should remain valid for a period of 60 (sixty) days beyond the date of completion of all contractual obligations of the supplier, including warranty obligations.
- (ii) Performance security may be furnished in the form of NEFT /Online(MDL website) Demand Draft / Pay order / Bank Guarantee / Insurance Security Bond / e-Bank Guarantee in favour of Mazagon Dock Shipbuilders Limited, Mumbai from the list of Banks approved by SBI / Canara Bank published on MDL website.
- (iii) Non submission of PS with in stipulated time period may lead to cancellation of order by MDL at risk and cost of seller. In case cancellation of order is not opted by the buyer and seller has already commenced supply / services, MDL shall withhold 5% of order value from his bills in lieu of PS. In such case, interest is to be recovered for the period starting from 26th day of transmission / notification of order/contract by any mode and amount involved at the relevant rate of interest. For foreign supplier, the interest will be EUROBOR/LIBOR plus 2%. For Indian suppliers, the interest will be SBI BPLR plus 2%.
- (iv) In case of foreign bidders, the performance security must conform to Uniform Rules for Demand Guarantees (URDG 758) - an international convention regulating international securities.
- (v) The performance security will be forfeited and credited to MDL's account in the event of a breach of contract by the contractor. It will be refunded to the contractor without interest, after he duly performs and completes the contract in all respects including the warranty under the contract.
- (vi) Where the duration of contract is very long and banks are unwilling to issue BGs for long duration, rolling bank guarantee towards performance security can be submitted where it will be valid for at least one year with claim period of three months within which the same can be extended for further period by amendment.
- (vii) Performance security on reducing balance can be accepted when the contract period extends beyond one year. This will be effective on completion of one year and thereafter on six monthly / yearly basis.
- (viii) In the event of defects due to poor workmanship leading to non-performance of the Equipment/Item and bidder failure to attend the defects within a reasonable period of time, the PSBG will be encashed by MDL. MDL's decision in this regard shall be final and binding on the supplier / contractor.
- (ix) In the event of postponing of delivery of deliverables/services or extension of guarantee desired & sought by MDL, the Performance Security (for 5% of order value) has to be extended and its amendment charges shall be borne by supplier.

7. Warranty/Guarantee: As per clause 23 of section I of TSP.

Note: Bidders have to quote for warranty /guarantee extension charges for one year beyond warranty clause mention in TSP for each yard in the price sheet attached with the tender. Bidder should note that these charges will not be considered for ranking purpose. Bidders shall not claim for warranty extension in case this clause is not being exercised.

8. Currency of Bidding:

Tender No. 170000539(Nominated Limited Global Tender Enquiry)

- (a) Indian Bidders shall quote in Indian Rupees only.
- (b) Foreign Bidders are allowed to quote price (and get paid) in RBI's notified basket of foreign currencies - US Dollar or Euro or GBP etc.

9. Delivery term/ Pricing:

- (a) **For Indian Bidders:** Prices of all items/services shall be quoted for delivery of the items/services to the following destination including charges towards inland transportation, inspection charges, insurance, custom duty & cess, and other local costs incidental to the delivery of the Goods/Services.

Items/services	Delivery Location at MDL / MDL Stores, Mumbai
----------------	---

- (b) **For Foreign Bidders:** Bidder shall quote the prices for the delivery on **Incoterm CIF, Mumbai/ JNPT port basis** for delivery at MDL. Order will be placed on **CIF basis** only.
- (c) The prices quoted shall remain firm and fixed during the currency of the order / contract unless agreed otherwise by MDL.

10. Taxes & Duties:

- (i) Bidders must clearly mention the applicable Taxes in the rate sheet enclosed in the tender. The item-wise rates (i.e. Basic + Duties & Cess + Packing, Forwarding, inspection charges, Freight & Insurance) quoted in the Rate sheet should exclude Taxes. Bidder should indicate GST rates as applicable separately under each of the head in the same rate sheet, which will be paid extra based on tax invoice to the extent applicable.
- (ii) Foreign bidder shall submit Tax Residency Certificate (TRC) in Part-I offer. In case of remittances to Foreign Companies for services, as per the Income tax act and DTAA provisions, TDS shall be carried out from the amount payable towards services. As per the extant applicability and existing rates, following cases pertaining to TDS are presented for clarity:
 - a) **Case 1 (TRC is made available by foreign bidders):** Tax Deduction at Source (TDS) @ 15% of total service payment is applicable or as per applicable TDS rate stipulated by Government of India. If this is not agreed to by the bidder in the bid or during TNC / CNC, then this shall be appropriately loaded as per applicable rates on the price for the purpose of ranking. However, bidders to note that TDS rates / DTAA rates differ from country to country. It varies from 10% to 25%.
 - b) **Case 2 (TRC is not made available by foreign bidders):** Tax Deduction at Source (TDS) at the rates as mentioned in the table below is applicable. If this is not agreed to by the bidder in the bid or during TNC / CNC, then this shall be appropriately loaded as per applicable rates stipulated by Government of India on the price for the purpose of ranking. These rates are tentatively as under:

Service Payment slabs (converted in INR)	Rate of TDS applicable on total service payment
Up to Value of INR 1 Cr.	25.75%
Above INR 1 Cr upto INR 10 Cr.	26.26%
Above INR 10 Cr.	27.0375%

- (iii) Foreign Bidders shall quote their price on **Incoterm CIF, Mumbai Basis**. Taxes & duties as applicable to be borne by buyer & seller in their own country i.e MDL will bear the taxes & duties applicable within India and for outside India same will be borne by seller/bidder.
- (iv) **Goods and Services Tax (GST) – Applicable for Indian Bidder:**
 - a) The prevailing rate of GST is to be indicated in your blank rate sheet in Part-I.
 - b) MDL's GST Number is **27AAACM8029J1ZA**.
 - c) Bidder/supplier shall comply as per GST act of India and responsible for the financial and non-financial consequences in case of non-compliance of GST provisions/requirements/timelines on their part.
- (v) End User Certificate if applicable. Format to be provided by vendor immediately after placement of order.

11. Payment Terms:

Tender No. 170000539(Nominated Limited Global Tender Enquiry)

- (i) **Items: For Indian Bidders:** On receipt of Invoice, 100 % of Payment shall be made within 15 days of receipt and acceptance of material and as reduced by any deductibles and / or the amount leviable towards liquidated damages, if any plus 100% taxes, duties etc. as applicable.

For Foreign Bidders: 100 % Payment made through LC for CIF Mumbai/JNPT port delivery against receipt of documents mentioned in payment mode.

If PSBG is not submitted, then the equivalent amount shall be retained.

- (ii) **Part Payment:** Part Supply, Part Payment shall be applicable.
- (iii) **Extended Warranty (if applicable):** 100% payment for warranty wherever included in the same order will be admissible for payment will be made within 15 days from date of start of extended warranty period.
- (iv) **Services:** 100% payment for all kinds of services wherever included in the same order will be admissible for payment **within 15 days** against certification by the designated acceptance authority after satisfactory completion of the respective activities/services and on receipt of invoice.

12. Payment Mode & Documents:

- (a) All the payments to indigenous bidders due shall be made through Real Time Gross Settlement (RTGS) / National Electronic Fund Transfer (NEFT) by MDL.
- (b) All the payments to foreign bidders shall be through Letter of Credit/Direct Remittance through Bank.
- (c) MDL may opt to make due payment for items having shelf life, services or any miscellaneous payment required as per contract through Direct Remittance from Bank post-delivery & acceptance or completion of services.

Note: Invoices should be submitted at "Receipt Section" adjacent to the ARS Punching Section, South Yard MDL.

(d) Documents for LC Payments for Goods(Foreign Bidders):

- (i) Set of Original + 2 Copies of signed Invoice showing item-wise prices as per the order.
- (ii) Set of Original + 2 Copies of signed packing List clearly showing list of items packed.
- (iii) Set of Original + 2 Copies Clean on Board Bill of Lading OR Air Way Bill Made in the name of MDL's Bank and Marked as freight paid.
- (iv) Set of Original + 2 Copies Certificate of approval OR Release Note from Inspection agency.
- (v) Certificate of country of origin in Original + 2 Copies by chamber of commerce.
- (vi) Original + 2 Copies of Warranty/Guarantee Certificate as per contract/order.
- (vii) Original + 2 Copies of all Manufacturer's Test Certificates (MTCs) / Reports, Drawings, Manuals, Procedures etc. as relevant to the ordered item.
- (viii) Certificate Confirming that supplier has couriered / dispatched _____ sets of Non Negotiable Documents comprising of all Test reports / MTCs, Technical Documents, Drawings, Manuals, Procedures etc. and of Signed Invoices, Packing Lists, Bill of Lading/AWB marked as Freight Paid, Insurance Policy/Document, Freight Paid Certificate, MDL nominated Inspection Agency's Certificate of approval, Country of Origin Certificate, Guarantee/Warranty Certificate, directly to MDL.
- (ix) Original + 2 Copies of the Certificate issued by the classified society confirming seaworthiness of the vessel and that the shipment is made on vessels of not more than 15 years vintage. (Applicable in case of CIF contracts / orders)
- (x) Certificate issued by MDL confirming that the delivery is made in time and no liquidated damages / penalty is applicable OR in case of delays, admissible amount of liquidated damages/ penalty will be specified by MDL in this certificate for reduction of equal amount from supplier's invoice and/or deduction of interest applicable towards non submission/delayed submission of PSBG and/or withholding the PSBG amount till guarantee/warranty period as applicable. (MDL will issue this certificate generally by E-Mail/FAX immediately on arrival of consignment at port of destination, receipt of signed copy of invoice, packing list, approval certificate of the nominated inspection agency, copies of B/L or AWB marked as Freight Paid, Insurance Policy/Document, Freight Paid Certificate or any other acceptable documents confirming dispatch on CIF basis).

Tender No. 170000539(Nominated Limited Global Tender Enquiry)

- (xi) Certificate confirming that the shipping instructions (inclusive of packing)/Sea/Air worthiness packing have been followed while packing / shipment and forwarding of details for Freight and insurance to MDL.
- (xii) All the documents should clearly indicate the Purchaser's Order number, Import License Number, Airway Bill / Bill of Lading Number, Insurance Policy number/ Insurance Document reference number.

13. Consignee:

- (a) Material scheduled for delivery are to be delivered at MDL Anik store located in Mumbai.
Note:-In order to avoid inconvenience during the delivery of material, it is advisable for supplier to depute their representative in their own interest to coordinate the activities between the transporter, and MDL stores.
- (b) Following document should be submitted along with material:
 - PO copy & subsequent amendments issued to it, if any.
 - Delivery Challans clearly indicating MDL Purchase Order No, Inspection Note Details and Packing List co-relating the items in the inspection report.
 - Copy of Warranty Certificate, Preservation Certificate etc as applicable.
 - Technical documentation, if applicable.
- (c) Unloading of the equipment/ items will be arranged by MDL. Supplier is required to give 4 day's advance intimation to MDL clearly indicating approx. dimensions and weight of consignments for arranging fork lift/crane for unloading.

Inspection & Testing: It shall be as per clause 11 of section I of TSP.

Inspection Agency: DNV. Charges towards the inspection shall be borne by supplier.

- (a) **Receipt Inspection:** MDL shall carry out necessary inspection of the items on receipt in the MDL on the basis of appropriate MDL Inspection system requirements & the Inspection documents submitted by suppliers. In case joint receipt inspection (JRI) is required to be carry out, same may be carried out along supplier's rep. Any objection raised by MDL inspection team against quality of material or workmanship shall be satisfactorily corrected by the supplier at his expenses including replacement as may be required within shortest possible time within 30 days. Items damaged during transit shall also be rectified or replaced by the supplier within shortest possible time.
- (b) **Rejection of the material:** Any portion of the equipment found defective/rejected, the supplier shall collect the same at his cost from the MDL Yard, all incidental charges being born by supplier, (inclusive of custom duty, if payable), within 30 days from the date of intimation to the supplier of such rejection. The MDL reserves the rights to dispose-off the rejected item at the end of a total period of 90 days in any manner, to the best advantage to the MDL & recover storage charges & any consequential damages, from sale proceeds of such disposal.

14. Loading Criteria:

Deviations sought by the bidder shall be loaded on the bidder/s quoted prices during price evaluation by MDL for ranking of bids to judge L1, as under.

- (a) Varied payment terms quoted by indigenous bidders as compared to the terms stated in the Tender document shall be normalized by adopting the Benchmark Prime Lending Rate of State Bank of India plus 2% thereon on the amount (s) at variation and / or for the period (in no. of days) at variation. For foreign bidders, LIBOR / EURIBOR rates plus 2 % or 6% whichever is higher would be applicable.
- (b) In case of Foreign bidders, L/C opening charges on CIF value, Interest for period of 20 days @ Benchmark Prime Lending Rate (BPLR) of SBI+2% on payment amount to be loaded if applicable for ranking purpose. In case of only foreign bidders quote this clause is not applicable.
- (c) If Service Component exists in an offer from a foreign vendor, then Tax Residency certificate (TRC) should be submitted with Part I offer. If no TRC is submitted, then the enhanced Income Tax rate and GST thereon will be considered while determining L-1.
- (d) For the additional delivery period sought by the bidder over the stipulated date of delivery as per Tender, 0.50% per completed week will be loaded to the quoted price.

15. Ranking of Bids: Tender line items are inseparable and non-divisible in nature.

- (a) Ranking of bids shall be done on total value wise by considering following factors:

Tender No. 170000539(Nominated Limited Global Tender Enquiry)

- i. The comparison of the responsive tenders shall be on total outgo on Least Cost Net of Credit Basis (LCNC), for the procurement to be paid to the supplier or service provider, including all elements of costs, duties, levies, freight, insurance etc. excluding GST (where ITC is available). Therefore, it should normally be on the basis of CIF/ FOR destination basis, duly delivered, commissioned, as the case may be.
 - ii. The foreign bidders shall quote on Cost, Insurance & Freight (CIF) basis. They should also to indicate the custom tariff number and custom duty applicable in India. To arrive at the Free On Rail (FOR) destination cost over and above CIF cost the following charges to added / loaded:
 - a. Port Handling Charges: @ one per cent of consignment value excluding services.
 - b. Custom duty, cess and surcharges: @ Eleven per cent of consignment value excluding services
 - c. Clearing agency charges & Inland freight: @ one per cent of consignment value excluding services.
 - d. For bids with Letter of Credit (LC) payment, the likely LC charges (as ascertained from MDL's bankers) should also be added.
 - e. Interest for period of 30 days @ base rate of SBI BPLR plus 2% (As notified by HoD(F) of MDL on quarterly basis) on payment amount is to be considered while evaluating foreign bidders for ranking purpose.
 - iii. In case both Indian and foreign bidders have quoted in the tender, the comparison of the offers would be done on the basis of FOR destination including all applicable taxes and duties (Where Input Tax Credit (ITC) cannot be availed by MDL) on the principle of the total outgo from MDL's pockets.
 - iv. In case there are no domestic bidders, a comparison of offers can be made on the basis of CIF/landed costs since the rest of costs would be same for all bidders.
 - v. The applicable loading towards deviations shall be loaded for ranking purpose.
- (b) For financial evaluation(Ranking), all bids shall be converted to Indian Rupees based on the "Bill for Collection (BC) selling "exchange rate on the last deadline for bid submission (Techno-commercial offer). If the last deadline for bid submission happens to be holiday or non-transaction day, the exchange rate on immediate previous working day will be adopted. The rate could be obtained from RBI/SBI rates as available on Internet.
- (c) Discount given, if any, by the bidders, after the last date for submission of the bids but before opening of the price bids, will not be considered for determining the ranking of bids but will be considered after the said bidder is adjudged as L1.
- (d) On-line ranking visible to the bidders after opening Part-II price bid is without loading parameters. However, the L1 bidder will be evaluated offline by applying all applicable loading parameters as per tender and clarifications during techno-commercial scrutiny / TNC meeting.
- (e) Loading/Ranking will be done on original submitted bid at the time of closing of tender. However, in case MDL invites supplementary price bid from technically qualified bidders, then same will also be considered while ranking of bids.

16. Integrity Pact (IP): The Integrity pact essentially envisages the agreement between prospective vendors / bidders & buyers committing the person/officials of both the parties not to exercise any corrupt influence on any aspects of the contract. Only those vendors/bidders who enter into such an integrity pact with the buyer would be competent to participate in the bid. The format of integrity Pact is available on MDL's website, details are at enclosure. IP shall be submitted on plain paper.

The 'Integrity pact' dully filled as per enclosed format to be submitted along with the offer. Bidders to ensure that each page of Integrity pact shall be duly signed by the bidder. **Non-submission of Integrity Pact by the bidders duly signed on each page along with Part-I bid is under liable for rejection.** Bidders shall send original IP immediately to MDL post submission of bid.

Independent External Monitors (IEM): The following Independent External Monitors (IEMs) will have the power to access the entire project document and examine any complaints received by him. In case of any change in IEMs it will be informed accordingly.
For any administrative enquires and clarification on tender, bidders shall contact Commercial Dealing Executive. In case of issues related to Integrity Pact (IP) please contact Independent External Monitor (IEM) whose details are as below:

Tender No. 170000539(Nominated Limited Global Tender Enquiry)

Mr. P V Rao

Email id: pasupuletirao@yahoo.co.in

- 17. Public Procurement Policy (Preference to Make In India) Order 2017:** This is applicable for this tender and details are available on MDL Website. Kindly visit MDL website Link : <https://mazagondock.in/English/pages/Tenders> under tab Ship Building(SB)/MPV Project. Class I, Class II and Non-Local bidders are eligible to bid against this tender.
- 18. Option Clause:** MDL the right to increase/decrease the ordered quantity by up to 50 % at any time, till final delivery date (or the extended delivery date of the contract), by giving reasonable notice even though the quantity ordered initially has been supplied in full before the last date of the delivery period (or the extended delivery period)
- 19. Book Examination Clause:** In case it is found to the satisfaction of the BUYER that the seller has engaged an Agent or paid commission or influenced any person to obtain the contract as described in clauses relating to Agents/Agency commission and penalty for use of undue influence, the seller, on a specific request of the buyer shall provide necessary information/Break-up data/ inspection of the relevant financial documents/information.
- 20. Public Grievance Cell:** A public grievance cell headed by Shri R. R. Kumar, ED (EY) has been set up in the company. Members of public having complaints or grievances are advised to contact above Authorities on Wednesday between 10.00 hours and 12.30 hours in his office at 3rd Floor, West Block, Mazagon Dock Shipbuilders Ltd or send their complaints / grievances to him in writing for redressal. Telephone No. is 23762106(MDL).
- 21. Breach of Obligation:** In case of breach of any obligation mentioned under, the bidder shall be disqualified / debarred from the bidding process for a period of one year from the date of notification;
- Bidder has withdrawn / modified / amended / impaired / derogated from the tender during the period of bid validity.
 - Bidder fails or refuses to execute the contract upon notification of acceptance of bid by MDL during the period of bid validity.
- 22. Land Border:** This is applicable for this tender and details are available on MDL Website. Kindly visit MDL website Link : <https://mazagondock.in/English/pages/Tenders> under tab Ship Building(SB)/MPV Project.
- 23. Right to Reject any or all Bids:** MDL reserves its right to accept or reject any or all Bids, abandon/ cancel the Tender process, and issue another tender for the same or similar Goods/Services at any time before the award of the contract. It would have no liability to the affected Bidder or Bidders or any obligation to inform the affected Bidder or Bidders of the grounds for such action(s).
- 24. Additional Instructions:**
- Bidder shall abide to all tender terms & conditions including General Conditions of Contract (GCC).
 - In case of improper on-line filling or non-submission of Acceptance formats for Tender Enquiry Form (TEF), GCC, it shall be presumed that all our tender terms & conditions are acceptable to the bidder. For GCC, kindly visit MDL website Link : <https://mazagondock.in/English/pages/Tenders> under tab Ship Building(SB)/MPV Project.
- 25. E-Portal and E-Tender Guidance:**
- Submission of bids against e-Tenders:** The bidder is required to quote online on the *e-Procurement* website www.eprocuremdl.nic.in by the deadline, by submitting the Techno-commercial Bid & Price Bid in Electronic format only. The prices/quotes & a few declarations shall have to be entered/uploaded by the bidder online in the Tender's entry forms & other bid documents' scanned/soft copies shall have to be uploaded as part of the bid. All bids should be digitally signed using DSC (as explained below).
 - To participate in e-Tender (s), every bidder must register themselves on the ASP's website (*registration is free of cost*) & must possess a legally valid Class-IIIB or above Digital Signature Certificate (DSC) as per IT Act-2000, using which they can sign their electronic bids. The DSC can be procured from any Certifying Authority (CA) authorized by Controller of Certifying Authorities (CCA) of Govt. of India.

Tender No. 170000539(Nominated Limited Global Tender Enquiry)

- c) National Informatics Centre (NIC) have been appointed by MDL as the Application Service Provider (ASP).
- d) Online User Manual is available on the website for the guidance of users & for participating in the e-Procurement/ e-Tendering, the bidder must ensure having the requisite (IT) infrastructure at their office premises.
- e) For any further details of e tendering & digital signatures, please contact 0120- 4200462, 0120-4001002, 8826246593, eproc-support@gov.in.
- f) Problems in hardware/software, internet connectivity, system configurations, Browser setting etc., for whatsoever reason shall not be considered for extension of tender closing date and time.
- g) MDL will not be responsible for an error in downloading of tender documents from web by the bidders. The version appearing on MDL website will be considered final and authentic.

26. **Contact Details for Queries: All bidders are requested to get their queries, if any, clarified in advance (i.e. 7 days in advance to tender closing date) to avoid last minute delay.** In case of any clarifications regarding tender, bidders are requested to contact the following executives.

Department	Name of Executives	Contact No	Email
Technical	Mr. Santosh Sitaraman DGM (SB-Design)	022 2376 3025	ssitaram@mazdock.com
	Mr. Amit D Dhuru CM(D-F)	022 2376 3375	addhuru@mazdock.com
Commercial	Mr. Satish Chandra CM/PE(C-P17A)	022 2376 2747	schandra@mazdock.com
	Mr. Anup Kawade M (C-P17A)	022 2376 2736	abkawade@mazdock.com

27. We look forward to receive your most competitive and reasonable offer against this tender.

Yours faithfully,

For MAZAGON DOCK SHIPBUILDERS LIMITED

Enclosure:

Enclosure-1	General Conditions of Contract (GCC) for Goods and Services
Enclosure-2	Integrity Pact(IP)Format
Enclosure-3	Performance Security (PS) Bank Guarantee Format
Enclosure-4	RTGS format
Enclosure-5	Details for remittance towards Performance Security (PS) Bank Guarantee Format
Enclosure-6	Contact Details of the bidder
Enclosure-7	Format for Compliance Certificate w.r.t. Land Border Clause
Enclosure-13-A	Format for declaration of Local Content & Purchase Preference as per PPP Order 2017. (Applicable for procurement below 10 Cr)
Enclosure-13-B	Format for declaration of Local Content & Purchase Preference as per PPP Order 2017. (Applicable for procurement above 10 Cr)

Tender No. 170000539(Nominated Limited Global Tender Enquiry)

Enclosure-14-A	Format for declaration of Actual Local Content (Applicable for procurement below 10 Cr)
Enclosure-14-B	Format for declaration of Actual Local Content (Applicable for procurement above 10 Cr)

Note: All above enclosures are available on MDL Website. Kindly visit MDL website Link : <https://mazagondock.in/English/pages/Tenders> under tab Ship Building(SB)/MPV Project.



MAZAGON DOCK SHIPBUILDERS LIMITED

(A Govt. Of India Undertaking)

**SHIPBUILDING DESIGN OUTFIT
DOCKYARD ROAD, MUMBAI - 400 010**



TECHNICAL SPECIFICATION FOR PROCUREMENT

OF

ANCHOR WINDLASS AND MOORING WINCHES

(QUANTITY: AS PER PR)

PROJECT	:	7500 DWT Multi-Purpose Dry Cargo Vessel
YARD NO	:	MDL YD No.21001/21002/21003/21004/ 21005/21006/21007/21008/21009/21010
CLIENT	:	NAVI MERCHANTS
DOCUMENT NO	:	SB / D-F / MPV / 2028

2	TSP Section I para 23,24,26,29 updated	12/03/2024	
1	Scope of supply of General requirements updated	01/03/2024	
0	First Issue for tendering	01/02/2024	
REV	DESCRIPTION	DATE	SIGN
			
	AKK	PSB	CGK Rao
	Prepared By	Checked By	Approved By

	MAZAGON DOCK SHIPBUILDERS LTD., (A Govt. of India Undertaking) Dockyard Road, Mumbai - 400 010.	DESIGN OUTFIT	TSP. NO.	SB/D-F/ MPV/2028
		TECHNICAL REQUIREMENTS FOR ANCHOR WINDLASS AND MOORING WINCHES	REV. NO.	2
			DATE	12/03/2024
			PAGE NO.	Page 2 of 23

CONTENTS

S. NO.	DESCRIPTION	PAGE NO.
I.	GENERAL REQUIREMENTS	3-17
1.	Subject	
2.	Ship Endurance	
3.	Class, Rules, Regulations, & Flag	
4.	Ship's Basic Particulars	
5.	Ship's Support Systems Supplies	
6.	Vibration	
7.	Noise Level	
8.	Manning Policy	
9.	Documentation	
10.	Quality Assurance And Testing	
11.	Test Trial and Inspection	
12.	Spares	
13.	Installation & Commissioning Consumables	
14.	Space Constraints	
15.	Interchangeability	
16.	Tally and Diagram Plates	
17.	Instruction Plates	
18.	Painting	
19.	Lifting Arrangement	
20.	Preservation / conditioning	
21.	Packing & shipping	
22.	Security of Information	
23.	Warranty	
24.	Planned ship Delivery Details	
25.	Weight Recording / Weight Certificate	
26.	Technical Assistance	
27.	Compliance Matrix and Deviation	
28.	Technical Offer as Per Shipyard Tender	
29.	Scope of supply	
II.	TECHNICAL REQUIREMENTS	18-19
III.	ANNEXURES	
1.	Compliance and Deviation List	21
2.	Weight Control Data Sheet	22
3.	Weight Certificate	23

	MAZAGON DOCK SHIPBUILDERS LTD., (A Govt. of India Undertaking)	DESIGN OUTFIT		TSP. NO.	SB/D-F/ MPV/2028
		TECHNICAL REQUIREMENTS FOR ANCHOR WINDLASS AND MOORING WINCHES	REV. NO.	2	
	DATE		12/03/2024		
	PAGE NO.		Page 3 of 23		
Dockyard Road, Mumbai - 400 010.					

Section I

GENERAL CONDITIONS AND REQUIREMENTS

1 **Subject:** The general conditions and requirements specified in this Section are intended to meet the functional requirements of the Equipment/ System elaborated in Section II and its associated auxiliaries/support systems; for meeting the overall requirements of the Vessel.

2 **Endurance:**
The endurance of the Vessel, at service speed of 11 knots, shall be about 5500 nautical miles.

3 **Class, Rules, Regulations & Flag:**

The Vessel will be registered under Danish flag and built under survey and in accordance with the rules of Classification Society of DNV.

Classification Notations : ✕1A

Ship Type Notation : Multi-purpose Dry Cargo Ship

Additional Class Notations:

Structural strength and integrity : GRAB (2-20): Hold designed for loading/discharging by grabs.

Strengthened (IB) : Inner bottom strengthened for heavy cargo

Propulsion, Power Generation and auxiliary systems

E0 : Unattended Machinery Space

Battery (Safety) : EES installation in one EES space has a rated capacity of 1000kWh or above not having the Battery (Power) notation

Navigation notations : NAUT (AW)

Cargo operations notations:

LCS : Loading computer system

Equipment and design features notations:

DG (B) : Carriage of dangerous goods in bulk acc. SOLAS Reg. II-2/19

DG (P) : Carriage of dangerous goods in packaged form acc. SOLAS Reg. II-2/19

DBC : Carriage of solid dangerous goods in bulk acc. IMSBC Code

Container : Equipped for carriage of Containers

Cold climate notations : Ice 1B

Environmental and pollution notations:

BWM (T) : Ballast Water Treatment

Clean : Controlling and limiting operational emissions and

	MAZAGON DOCK SHIPBUILDERS LTD., (A Govt. of India Undertaking)	DESIGN OUTFIT	TSP. NO.	SB/D-F/ MPV/2028
		TECHNICAL REQUIREMENTS FOR ANCHOR WINDLASS AND MOORING WINCHES	REV. NO.	2
	DATE		12/03/2024	
	PAGE NO.		Page 4 of 23	
Dockyard Road, Mumbai - 400 010.				

Recyclable : discharges ER (SCR) Installation of SCR System in exhaust main engine
: Inventory of hazardous materials

Survey arrangement notations:

BIS : In water survey
TMON (Oil lubricated) : Tail shaft monitoring (oil lubricated system)

Note: Final Class notations to be confirmed by Classification society.

3.1 RULES AND REGULATIONS:

The Vessel, including its hull, machinery and equipment shall be constructed in accordance with rules and regulations listed below and which are in force on the date of signing the contract.

1. Classification Society Rules for Multi-purpose vessel
2. Marine Laws and Regulations of Government of the Ship's Flag
3. SOLAS - International Convention for the Safety of Life at Sea 1974, or it's protocol of 1988 and up to amendments 2023 January.
4. ILLC - International Load Line convention, 1966/1988 and amendments up to 2014
5. International Regulations for Tonnage Measurement of Ship, 1969
6. COLREG - Convention on International Regulations for Prevention of Collision at Sea, 1972 and amendments up to 2013.
7. MARPOL - International convention for the Prevention of Pollution from ships, 1973 and protocol of 1978, amendments up to 2022 January.
8. FSS Code - International Code for Fire Safety Systems
9. FTP Code - International Code for Application of Fire Test Procedures
10. LSA Code - International Life-saving Appliance Code
11. ISPS Code - International Code for the Security of Ships and of Port Facilities.
12. IS Code - International code on Intact Stability, 2008
13. Grain Code - International Code of Safe Carriage of Grain in Bulk
14. Maritime Labor Convention of 2006 (MLC 2006) except swimming pool & separation of deck & engine office
15. Noise Code - Code on noise levels on board ships, Resolution MSC.337(91)
16. ISO 6954-2000(E) "Mechanical vibration - Guidelines for the measurement, and evaluation of vibration with regard to habitability on passenger and merchant ships"
17. IACS Rec 47 — Shipbuilding and Repair Quality Standard — rev.8 Oct.2017 and latest amendments
18. EEDI according Ch 4 of MARRPOL Annex VI, including verification according IMO resolution MEPC.254(67). as amended

	MAZAGON DOCK SHIPBUILDERS LTD., (A Govt. of India Undertaking) Dockyard Road, Mumbai - 400 010.	DESIGN OUTFIT		TSP. NO.	SB/D-F/ MPV/2028
		TECHNICAL REQUIREMENTS FOR ANCHOR WINDLASS AND MOORING WINCHES		REV. NO.	2
				DATE	12/03/2024
				PAGE NO.	Page 5 of 23

19. ISO 8468 international standard of bridge layout and associated equipment.
20. PSPC Performance Standard for Protective Coatings for dedicated seawater ballast tanks in all types of ships and double-side skin spaces of bulk carriers, MSC.21 5(82)
21. AFS, "International Convention on the Control of Harmful Anti-Fouling Systems on Ships, 2001";
22. BWM "International Convention for the Control and Management of Ships Ballast Water and Sediments, 2004" and IMO Res. A.868(20) and USCG regulations, "Guidelines for the Control and Management of Ships' Ballast Water to Minimize the Transfer of Harmful Organisms and Pathogens"
23. IMO Resolution A.962(23) - IMO Guidelines on Ship Recycling as amended by IMO Resolution A.980(24), or Ship Recycling Convention 2009, including complete inventory of hazardous materials (IHM) as per MEPC.269(68)
24. IMO MSC.277(85): ships which occasionally carry dry cargoes in bulk
25. IMSBC Code – International Maritime Solid Bulk Cargoes Code – Resolution MSC.268(85) (Italy bulk certificate)
26. International Telecommunications & Radio Conference Regulations 2012 (WCIT 12) and 2019 (WRC 19) with annexes and revisions.
27. IEC requirements for electrical installation for ships TC 18/2022 with amendments.
28. Resolution MSC.137(76) - Standards for Ship Manoeuvrability - (adopted on 4 December 2002)
29. IMO MSC/Circ. 1053 – "Explanatory Notes to the Standards for Ship Manoeuvrability"
30. Resolution A.714(17) CSS Code - Code of Safe Practice for Cargo Stowage and Securing (as far as practicable).
31. IMO Resolution MSC.1/Circular.1353/Rev.2 (7 December 2020) "Revised guidelines for the preparation of the cargo securing manual"
32. IMO Resolution MEPC.245(66) "2014 Guidelines on the method of calculation of the attained energy efficiency design index (EEDI) for new ships"
33. Resolution MEPC.254(67) – 2014 Guidelines on Survey and Certification of the Energy Efficiency Design Index (EEDI)
34. IMO Resolution MEPC.282(70) "2016 Guidelines for the Development of a Ship Energy Efficiency Management Plan (SEEMP)" and Amendments. (to be prepared by the Builder)
35. ISO 7547 – Air conditioning and ventilation of accommodation

	MAZAGON DOCK SHIPBUILDERS LTD., (A Govt. of India Undertaking) Dockyard Road, Mumbai - 400 010.	DESIGN OUTFIT	TSP. NO.	SB/D-F/ MPV/2028
		TECHNICAL REQUIREMENTS FOR ANCHOR WINDLASS AND MOORING WINCHES	REV. NO.	2
			DATE	12/03/2024
			PAGE NO.	Page 6 of 23

- spaces on board ships
36. ISO 8861 – Engine-room ventilation in diesel-engine ships
 37. Kiel Canal Rules
 38. Black Sea Rules as far as practicable
 39. Panama Canal Navigation Rules including Tonnage Measurement as far as practicable
 40. U.S.C.G. Rules and Regulations for foreign flag Vessels operating in navigable waters of the United States
 41. Suez Canal Navigation Rules including Tonnage Measurement
 42. IMDG Code – International Maritime Dangerous Goods Code

4 Ship's Basic Particulars:

Table 1

Dimensions:

Length overall	: 116.20	m
Length between perpendiculars	: 113.60	m
Breadth, moulded	: 17.50	m
Depth, moulded	: 9.80	m
Draught, moulded	: 6.50	m
Freeboard	: Type B	
Endurance	At service speed of 11 knots	5500 NM
Ship's displacement	Deep displacement	Around 7000 Tonnes

- 5 Ship's Support Systems Supplies:** - Following ship's support supplies shall be available for the equipment system. For electrical supplies, in case of different requirements (voltage/frequency, etc.), the equipment supplier shall provide suitable provision (transformer/converter/UPS, etc.).

Table 2

S.No	SYSTEM	SUPPLIES	REMARKS
(a)	Compressed air system	For Engine Starting Air at 3.0 MPa at 50 cu m/hr and For Working Air at 0.7 MPa & 80 cu m /hr.	Specific provisions shall be provided by the equipment supplier.
(b)	Fresh water system	Fresh water filling for equipment system shall be provided by ship's fresh water hydrophore system.	Specific requirements to be indicated by equipment supplier.
(c)	Electrical	400 V AC @ 50 Hz, 3 phase	Specific provisions shall be

	MAZAGON DOCK SHIPBUILDERS LTD., (A Govt. of India Undertaking) Dockyard Road, Mumbai - 400 010.	DESIGN OUTFIT	TSP. NO.	SB/D-F/ MPV/2028
		TECHNICAL REQUIREMENTS FOR ANCHOR WINDLASS AND MOORING WINCHES	REV. NO.	2
	DATE		12/03/2024	
	PAGE NO.		Page 7 of 23	

		230 V AC @ 50 Hz, 3 or 1 phase.	provided by the equipment supplier.
--	--	---------------------------------	-------------------------------------

6 Vibration:

Special attention is to be paid in design and manufacture of the equipment to prevent undue vibration. Vibration limits, evaluation and measurement shall follow the provisions of ISO 20283-5:2016, Mechanical Vibration – Guidelines for the measurement, reporting and evaluation of vibration with regard to habitability on passenger and merchant ships.

Vibration velocity limits are not applicable near equipment seatings.

The vibration measurement is to be made at sea trial condition and when the Vessel is running ahead steadily at the continuous service output of the main engine.

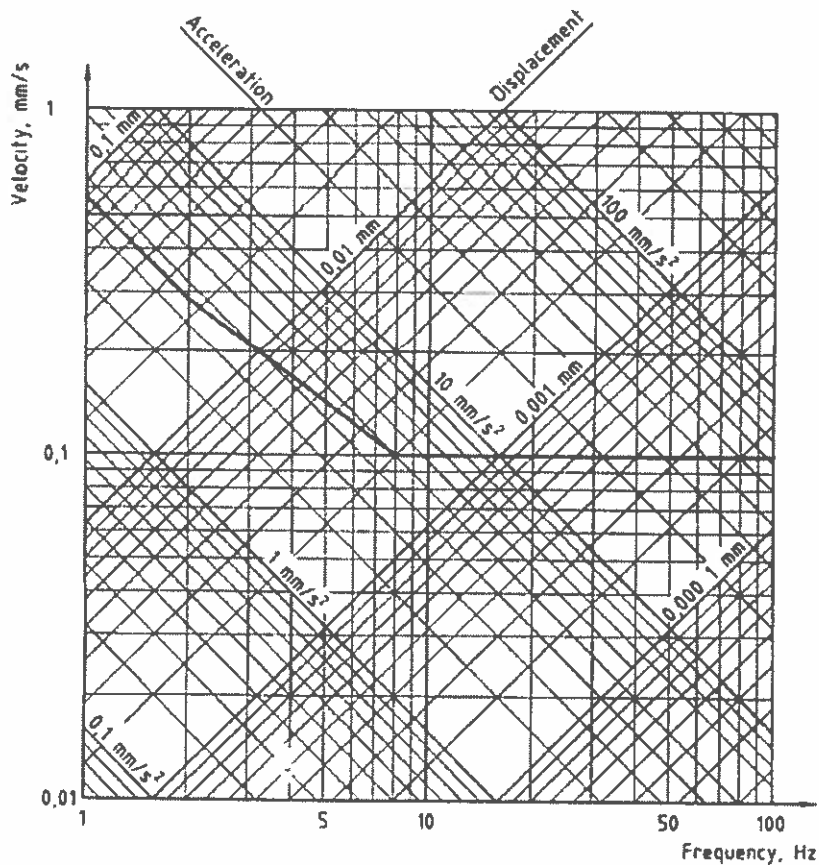

Human sensitivity curve

	MAZAGON DOCK SHIPBUILDERS LTD., (A Govt. of India Undertaking)	DESIGN OUTFIT	TSP. NO.	SB/D-F/ MPV/2028
		TECHNICAL REQUIREMENTS FOR ANCHOR WINDLASS AND MOORING WINCHES	REV. NO.	2
	DATE		12/03/2024	
	PAGE NO.		Page 8 of 23	
Dockyard Road, Mumbai - 400 010.				

If Vibration level exceeds the limit of the above defined criteria, vendor to make necessary improvement to a practical extent. Vendor shall submit the vibration analysis (prediction) report for MDL's reference.

7 **Noise Level:**

Vendor shall ensure that the noise level for equipment in the accommodation space and engine room is to be within the limits specified in IMO.MSC 337(91), Code on Noise Level on board ships. In addition, vendor shall endeavour to achieve a noise level of max. 65dB for the equipment in the ECR.

Noise level measurement is to be carried out in the following conditions:

- i. During the sea trial when running ahead steadily continuous service output of the main engine with shaft generator at normal operating condition and all fans running.
- ii. During the sea trial when running ahead steadily continuous service output of the main engine and 1 generator running at normal operating condition and all fans running.
- iii. Harbour mode with 1 generator running
- iv. Harbour mode with emergency generator running

Measuring methods and points, measurement devices and reporting shall be in accordance with the Noise Code.

In case the measured noise level exceeds the above values, necessary improvements shall be made to a practical extent.

All engine room alarms shall be clearly audible above the noise of the running engine room machinery.

8 **Manning Policy:**

- i. The machinery spaces are envisaged for unmanned continuous operation. The spaces will be attended for starting/shutdown procedures and for routine checks.
- ii. Controls and surveillance on board the ship will be through Remote controls.
- iii. Each vital machinery shall be capable of control at the equipment level and need to be monitored from specified control station as recommended by the vendor as per class rules.

9 **Documentation:** -

Various documents will be submitted by the equipment supplier as per the scope of supply and responsibility. Quality documentation is to be submitted in comprehensive and time bound manner for meeting ship's detailed design and production targets as well

	MAZAGON DOCK SHIPBUILDERS LTD., (A Govt. of India Undertaking)	DESIGN OUTFIT		TSP. NO.	SB/D-F/ MPV/2028
		Dockyard Road, Mumbai - 400 010.	TECHNICAL REQUIREMENTS FOR ANCHOR WINDLASS AND MOORING WINCHES		REV. NO.
	DATE				12/03/2024
	PAGE NO.				Page 9 of 23

as equipment production and delivery schedule. Documentation to be submitted by the equipment supplier are broadly indicated below:-

Table 3

SN o.	Documentation	Remarks	Timeline (In Weeks)
(a)	i) Binding design documentation and ii) (QAP) Quality Assurance Plan	For progressing with detailed design . Equipment quality assurance during production	PO + 02
(b)	(ii) FATs procedure.	Equipment quality assurance during FATs.	PO + 06
(c)	Equipment STW/HATs/SATs documentation	For preparing installation inspection/Test and Trials documentation	PO + 12
(d)	Technical Manuals for equipment operation, maintenance, logistics, etc.	For ship's crew, training and repair organizations.	PO + 14

All documentation (including documents, drawings, data, reports, manuals, etc.) should be in English language. Dimensional details in the drawings should be as per scale. Technical data and parameters should be in metric units (SI Units). Orthographic drawings & 3D model of equipment (associated components), in soft copies are to be submitted. Following file/formats would be acceptable:-

- a. Documents, data & reports in MS-WORD / EXCEL/ PDF, as applicable
- b. ACCESS for data base files
- c. Orthographic drawings (2D) in .DXF / .DWG format.
- d. 3D model of equipment (associated components) in .STP/ .IGES format.

Note: Above drawings/data are to be submitted in soft copies in latest software version.

Overall documentation must be of high quality in terms of contents, clarity and completeness; for meeting the requirements of detailed design, integration, manufacturing, quality assurance, installation, trials and operation/maintenance of the equipment.

All documents shall be sent electronically in PDF format without encryption and password. Printing of PDF provided by vendor shall be possible.

Vendor shall supply electronic copies (2 sets) of all finished plans and manuals to the MDL including Class approved drawings duly stamped together with associated Class approval letter without delay. All finished plans and manuals shall be in printable PDF format without password or encryption. All instruction books shall be provided in printable electronic format.

Vendor shall supply electronic copies (2 sets) and two (2) hard copy of drawings, manuals and instruction books for main and auxiliary machinery and all other major components such

	MAZAGON DOCK SHIPBUILDERS LTD., (A Govt. of India Undertaking)	DESIGN OUTFIT	TSP. NO.	SB/D-F/MPV/2028
		TECHNICAL REQUIREMENTS FOR ANCHOR WINDLASS AND MOORING WINCHES	REV. NO.	2
	DATE		12/03/2024	
	PAGE NO.		Page 10 of 23	
Dockyard Road, Mumbai - 400 010.				

as motors, pumps, navigation & communication equipment, etc. to MDL. The instruction books from suppliers shall be provided only for the first Vessel if there are no change for the Vessel series.

One (1) hard copy of instruction books from suppliers to be provided in advance to Buyers site office.

The drawings and documents which need approval by the Classification society are to be submitted to the society directly by the Builder or Designer. In the event of any discrepancy between MDL and the Classification society or relevant authorities for approval drawings, the Classification society's or relevant authority's approval comments are to be in force and be adopted.

Approval by the Classification society and / or other regulatory authorities shall in no way be interpreted as approved by MDL, and MDL shall be entitled to make further requests provided they do not conflict with the requirements of specification of the PO.

Two (2) sets of instruction books and manuals of all equipment and systems to be furnished to MDL in electronic format (USB type storage device) in PDF or other agreed format; one each to the Vessels and to MDL. USB type storage device shall contain finished manuals and instruction booklets of all equipment as far as practical. Vendor is to supply two (2) hard copies of the finished drawings (as built) to MDL.

10 Quality Assurance And Testing :

As per class requirement.

11 Test, Trial and Inspection :

Tests and trials shall be carried out, in general, according to the Builder's usual standard practice and normal international shipbuilding practice in the presence of the surveyor of the Classification Society and the Buyer's and the Builder's representatives.

The Supplier shall submit the procedure and schedule of test and trial for the Buyer's approval. All results to be recorded and presented to the Buyer.

Following notice to be given for tests and inspections in shipyard and outside shipyard:

- Two (2) working day for shipyard test and inspections in general
- Four (4) working days for outside shipyard tests and inspections in country of shipyard
- Twenty five (25) days for outside shipyard tests and inspections in country other than the one of shipyard.
- Four (4) weeks for Factory Acceptance Tests

a. Shop Test and Inspection

Shop tests and / or inspection of machinery and equipment shall be carried out in accordance with the Builder's and / or Manufacturer's standard practice, except specially mentioned in Section II of this Specification.

Detailed description of shop tests except for minor equipment shall be referred to respective clauses of the Specification.

	MAZAGON DOCK SHIPBUILDERS LTD., (A Govt. of India Undertaking)	DESIGN OUTFIT		TSP. NO.	SB/D-F/ MPV/2028
		TECHNICAL REQUIREMENTS FOR ANCHOR WINDLASS AND MOORING WINCHES	REV. NO.	2	
	DATE		12/03/2024		
	PAGE NO.		Page 11 of 23		
Dockyard Road, Mumbai - 400 010.					

- b. FATs-(Factory Acceptance Trials) (Acceptance Test Procedure) ATP(QAP document)

Documentation on equipment FATs procedure is to be submitted by equipment supplier in time bound manner, well in advance for approval by the designated inspection organization.

- c. Harbour Acceptance Trials/Sea Acceptance Trials: -

During equipment setting to work and HATs/SATs, equipment suppliers shall assist and offer the respective equipment trials for successful completion of trials phase. Equipment testing, tuning and any defect rectification during on-board trials shall be undertaken by the equipment supplier in efficient and effective manner.

The HATs/SATs document is to be submitted by the supplier. HATs/SATs shall be carried out to the satisfaction of Inspection agencies.

- 12 Spares: -** Spares, are to be recommended by equipment supplier, taking into account operational and maintenance requirements of the equipment. Equipment supplier shall submit comprehensive list of all types of spares & tools along with the technical offer. The list of spares to be supplied should comply with class requirements and those listed in Section II of this document.

13 Installation & Commissioning Consumables: -

- a. **Installation Tool:** Special tools, jigs and fixtures & test equipment required for Installation, flushing, setting to work, testing & tuning, on-board trials (HATs/SATs) and post Sea Trials inspection of critical internal parts and reassembly of the equipment and its auxiliary systems shall be supplied.
- b. **Commissioning Consumable:** The Commissioning consumables (first charge like coolants, greases, special oil, filters, gaskets, refrigerant etc.) shall be included in the scope of supply. Commissioning consumables shall be delivered before STW of the main equipment, tentative schedule of which shall be indicated in the Tender Enquiry.

- 14 Space Constraints:** - While designing the equipment and its associated auxiliaries/components the supplier is required to take into consideration the space availability in the respective compartments of the ship, ease of operation/maintenance of the equipment on-board the ship, ergonomics aspects and safety. Maintenance envelopes for equipment and its auxiliaries/components shall be provided by the equipment supplier and assessed in consultation with the Shipyard/ owner for finalizing the layout of respective ship compartments. Optimisation in design is to be ensured while meeting the functional, maintainability and ergonomic requirements.

Limiting dimensions & weight of the equipment are to be indicated by the OEM.

	MAZAGON DOCK SHIPBUILDERS LTD., (A Govt. of India Undertaking)	DESIGN OUTFIT	TSP. NO.	SB/D-F/ MPV/2028
		TECHNICAL REQUIREMENTS FOR ANCHOR WINDLASS AND MOORING WINCHES	REV. NO.	2
	DATE		12/03/2024	
	PAGE NO.		Page 12 of 23	
Dockyard Road, Mumbai - 400 010.				

Table – 4

<u>Equipment</u>	\leq	Section 1.01 Length	Section 1.02 Breadth	Height	Mass
Anchor Windlass with Mooring Winches	\leq	4535 mm	1930 mm		6400 Kg
Mooring Winches		2580 mm	1775mm		2500Kg

OEM to comply with the limiting dimensions indicated in Table 4. Non-compliance of the said limiting dimensions shall be liable for rejection.

- 15 Interchangeability:** - Equipment design is to ensure that components and parts having same dimensions and characteristics should be inter-changeable between different units of similar kind, without affecting the specified equipment performance.
- 16 Tally and Diagram Plates:** - All major components, including fittings such as valves, cocks, levers, gauges, switches, etc., should be provided with suitable identification tallies for appropriate identification. Tally plates shall be in English language and in SI units. All tallies and diagrammatic plates shall be of anodised aluminium alloy. Tallies for safety, caution & warning considerations should be in bold black letters on a fluorescent orange background. Diagrammatic plates indicating details of connections are to be provided / affixed near the terminal box of the motor.

Additional details required are as follows:

- a. Motor details such as HP (kW), Starting Current, Full Load Current, rpm, Insulation, Weight, Maker's Name, Sr. No. of Machine, Year of Manufacturing, Weight of Equipment, IP Rating of the equipment etc. shall be given in the motor tally plate.
 - b. Danger labels in Red colour with white lettering are to be provided on all electrical equipment operating on 150Volts or higher
 - c. Motor winding terminals ending at Connection Box shall have engraved tally number.
 - d. The diagram plate, which is fixed on the rear side of the front door, shall have complete wiring diagram of the starter with sub-component identification number. The same identification number shall be engraved on the components fitted on the starter.
 - e. Internal Cable-Cores terminating at the connection terminal strip shall have the same corresponding terminal ferrule no. Fixed / fitted on it.
 - f. Tally of JB/Panel and other equipment internal diagram plate to be prepared by OEM.
 - g. Cable Tallies as per approved system drawing to be prepared by OEM.
 - h. Cable tallies should be supply for both the ends.
- 17 Instruction Plates:** - Instruction plates listing the starting/shut-down procedure and precautions in brief are to be prominently displayed on the equipment. The Instruction plates are to be anodized (anodised aluminium alloy). Equipment is to be supplied with a set of instruction plates duly mounted on equipment or supplied loose.
- 18 Painting:** - Standard painting procedure shall be applicable for suitability for marine environment. Colour scheme for painting the equipment shall be indicated subsequently/during TNC meeting.

	MAZAGON DOCK SHIPBUILDERS LTD., (A Govt. of India Undertaking) Dockyard Road, Mumbai - 400 010.	DESIGN OUTFIT		TSP. NO.	SB/D-F/ MPV/2028
		TECHNICAL REQUIREMENTS FOR ANCHOR WINDLASS AND MOORING WINCHES		REV. NO.	2
				DATE	12/03/2024
				PAGE NO.	Page 13 of 23

19 Lifting Arrangement: - Equipment components weighing more than 25 kilograms are to be provided with eyebolts, for ease of handling/lifting on board the ship or ashore. During transportation/transit of equipment, adequate provisions (such as supports, locking arrangement, jacking, etc.) are to be made for preventing any damage to the equipment & its associated components. Any component requiring special handling shall be clearly marked and appropriate handling instructions shall be provided by equipment supplier. One set of lifting gear shall be supplied to MDL.

20 Preservation / Conditioning:

Equipment supplier is to provide high quality packing for the complete scope of supply along with handling arrangements. The package/container should display clear instructions for stowage, handling, care and accessibility for inspection of equipment preservation condition.

Equipment shall be supplied with Initial preservation for a period of 24 months for tropical conditions and protected against high humidity. The equipment is to be preserved on delivery as per the standard marine engineering practice. Closing plates/plugs/caps are to be provided on all openings.

For re-preservation requirements, at shipyard or on board ship beyond initial preservation period, suitable provision is to be catered for by equipment supplier. Equipment supplier shall provide re-preservation & upkeep procedure, preservatives/consumables and technical assistance/supervision to the shipyard, as per requirements. (If special equipment/Pumps, hoses, fittings, etc. required shall be brought by the supplier along with them for carrying out the preservation on board the ship.

21 Packing & Shipping:

All equipment shall be adequately packed and protected with supports to ensure adequate protection during all methods of transportation. Each unit within a package/container shall be clearly marked in English for identification. The container shall clearly indicate the commodity description with caution marks, weight, size, etc.

A separate document giving complete details & instruction for storage, preservation, handling & transportation after delivery shall be supplied & a copy must be included with the shipping document. The supplier should indicate the delivery schedule port of embarkation, transport, packing, preservation, insurance etc.

Following items shall be packed in separate containers/boxes with proper colour coding (with description) & list of their contents in English for their easy identification and traceability:

- a) Deliverables related to Main Equipment (to be marked in green colour).
- b) Deliverables related to Auxiliary Equipment (to be marked in green colour).
- c) Deliverables related to Installation material and Tools related to Main & Auxiliary Equipment (to be marked in green colour).
- d) Commissioning consumables and Tools (to be marked in green colour).
- e) Spares and Tools (to be marked in red colour).

	MAZAGON DOCK SHIPBUILDERS LTD., (A Govt. of India Undertaking) Dockyard Road, Mumbai - 400 010.	DESIGN OUTFIT	TSP. NO.	SB/D-F/ MPV/2028
			REV. NO.	2
		TECHNICAL REQUIREMENTS FOR ANCHOR WINDLASS AND MOORING WINCHES	DATE	12/03/2024
			PAGE NO.	Page 14 of 23

f) Documentation (to be marked in blue colour).

The list of actual deliverables against each of the above serials shall be forwarded to shipyards in soft copy (MS Excel format) with required part nos. within one week of finalization of PNC in order to detail them in the purchase order.

Packing list should give further breakup of items, wherever particular item is quantified by set.

22 Security of Information: - The information contained in this document is not to be divulged to any other firm/third party without the prior permission of MDL. Adequate measures are to be taken to ensure safe custody of this document.

23 Warranty: The equipment along with associated auxiliaries/components shall be warranted by the equipment supplier for the stipulated performance for a period of twelve (12) months after planned delivery date (D) (Refer table 5.below) of the ship by MDL to the Owner.

During the said period, the equipment supplied shall be warranted against any malfunction, defects, material failure, and non-compliance to ordered specifications, sub-optimal performance, design deficiency, poor workmanship and quality. Any expense on account of equipment malfunction, repair or supply of spares against guarantee defects is to be borne by the equipment supplier. In case, warranty extension is required the same is to be catered for by the equipment supplier. If any defective part to be taken back to OEM's factory (i.e. importing and re-exporting from Country of origin), for service purpose the liability of the same shall be borne by the supplier.

Extension to Warranty: Supplier shall mandatorily indicate, in the offer, the annual rate for extended warranty period, along with the commercial terms and conditions if any.

The rates are to be indicated for the equipment in preserved state as well as for the equipment having been de-preserved and in operation.

24 Planned Ship Delivery Details(D): The planned dates for delivery of the Ships to the Owner by MDL is tabulated below:

Table 5:

Ship no.	Yard No.	Planned Delivery date
1	21001	Apr 2026
2	21002	June 2026
3	21003	Aug 2026
4	21004	Oct 2026
5	21005	Dec 2026
6	21006	Feb 2027
7	21007	Oct 2028
8	21008	Dec 2028
9	21009	Dec 2028
10	21010	Feb 2029

25 Weight Recording / Weight Certificate: - Weights of all components are to be recorded and a suitable certificate shall be submitted, by the equipment supplier.

	MAZAGON DOCK SHIPBUILDERS LTD., (A Govt. of India Undertaking) Dockyard Road, Mumbai - 400 010.	DESIGN OUTFIT	TSP. NO.	SB/D-F/ MPV/2028
			REV. NO.	2
		TECHNICAL REQUIREMENTS FOR ANCHOR WINDLASS AND MOORING WINCHES	DATE	12/03/2024
			PAGE NO.	Page 15 of 23

The designated inspection authorities shall countersign such certificates. Format for weight control data sheet, is placed at Annexure 2 of this document.

Net weight of each component is to be recorded in presence of designated inspection authority and the weight certificate is to be submitted by the equipment supplier, along with equipment supply. Format for weight certificate, is placed at Annexure 3 of this document.

26 Technical Assistance:-

The Supplier shall provide the necessary representative(s) to assist, **as and when required**, in carrying out inspection and supervise the work that is done on the equipment, during the following phases:

- a. Preparation for installation of equipment by shipyard.
- b. Monitoring of proper equipment preservation during storage.
- c. Setting to Work (including fitment of latest calibrated instrumentation).
- d. Assistance during Harbour trials (till clearance by Shipyard & Class).
- e. Assistance during Sea trials.
- f. Assistance in trouble shooting / attending equipment operational problem till warrantee period
- g. Post CST equipment Inspections.

The supplier shall provide Manday rates for each Ship for the above activities. The supplier shall indicate total cost for executing all technical assistance activities mentioned above, in the price bid. Activity-wise cost break up shall also be given in the price bid, to facilitate the payment on satisfactory completion of the activity.

Shipyard has to progress on ship construction activities, simultaneously on ships of the same Class/Project or on ships of different projects. View this; there shall be every likelihood of clash of requirement of technical assistance. In such eventuality, in order to avoid delays on one ship due to similar work requirement on other ship, supplier shall depute their dedicated separate/independent team of supervisors/specialists for required technical assistance, on the required ships. Rotation of supervisors/specialist amongst the various ships/projects shall be avoided.

The supplier shall provide checklist for installation, setting to work, HATs & SATs to the shipyards to ensure the completeness of the activities by shipyards in order to avoid waiting period of the supplier specialists.

27 Compliance Matrix and Deviation : - Para-wise compliance matrix, including Para which are not applicable, as per the technical specifications (contained in this document) shall be submitted by the equipment supplier along with the technical offer, in the format at Annexure 1 (The technical offer received without Compliance Matrix shall be liable for rejection)

28 Technical Offer as Per Shipyard Tender: - Technical part of the offer with respect to the equipment and its associated auxiliaries/components/controls, to be submitted by the equipment supplier in comprehensive, systematic and structured manner, as per the requirements mentioned in this document, including the following (but not limited to):-

- i. Equipment description along with specifications.
- ii. Equipment performance data
- iii. Characteristics data, curves, efficiency, etc., related to equipment performance

	MAZAGON DOCK SHIPBUILDERS LTD., (A Govt. of India Undertaking)	DESIGN OUTFIT	TSP. NO.	SB/D-F/ MPV/2028	
			REV. NO.	2	
	Dockyard Road, Mumbai - 400 010.	TECHNICAL REQUIREMENTS FOR ANCHOR WINDLASS AND MOORING WINCHES	DATE	12/03/2024	
			PAGE NO.	Page 16 of 23	

- iv. Outline general arrangement drawings of equipment with footprint, main dimensions, weights and mounting arrangement.
- v. Associated support systems specifications and drawings.
- vi. Interface requirements.
- vii. Relevant drawings with all views and maintenance envelopes.
- viii. Control and monitoring system along with complete list of sensors and instrumentation (in structured manner).
- ix. Mounting data/details and characteristics along with minimum stiffness required for seating/foundation.
- x. Associated electrical equipment specifications and drawings.
- xi. Recommended list of spares, special tools, test equipment, etc., in systematic manner.
- xii. Preliminary quality assurance and test plan.
- xiii. Compliance matrix (Para-wise compliance to tender specifications).
- xiv. Proposed plan for technical assistance for installation, preservation and commissioning, trials, etc.
- xv. List of items required for auxiliary systems (shipboard systems), which are essentially, be fitted for proper functioning of main equipment. Also indicate any of them, which are not supplied along with main equipment.
- xvi. List of Instrumentation & Diagram.
- xvii. Clear demarcation between the scope of supply of firm and that of the yard.
- xviii. Trial and commissioning time of complete system on board.
- xix. Delivery time from receipt of order.
- xx. List of special tools, instruments, jigs & fixtures & facilities required for lifting, transporting, aligning, installing and commissioning of main equipment and their auxiliaries.
- xxi. Details of all connections to plant, Mounting details with pattern no, seat details, flange details etc.

29 SCOPE OF SUPPLY :

- i. Main equipment as detailed in Section II of this document.
- ii. Auxiliaries related to the Main equipment and its Electrical and Control Systems viz. Starters, Control Panels, Indicators etc. on Ship's foundation/structure. They shall be delivered along with Main Equipment.
- iii. All flexible hoses/bellows, interface flanges, counter-flanges, couplings, pipe stubs and fasteners, required to connect Main and Auxiliary Equipment to the ship's piping. They shall be delivered along with Main Equipment.
- iv. All mating electrical connectors, plugs and sockets for supplied equipment, for assembly with ship's interconnecting cables. Cable glands should be as per BS 6121/EN 62444-2013 and are to be provided at the bottom of the panel. The body of the gland should be made of mild steel and nut of brass. The terminals used are to be approved type, adequately spaced & clearly marked for ease of connection & inspection. Suitable crimping type connectors of electrolytic copper and terminal clamps of Naval brass must be provided for termination of the permanent cables. They shall be delivered along with Main Equipment.
- v. Deliverables related to Installation material and Tools required carrying out installation, alignment of Main and Auxiliary Equipment (shall be delivered along with Main Equipment).
- vi. Commissioning Spares and Tools (including special tools / instruments / gadgets required to conduct HATs and SATs) shall be delivered before STW of the Main and Auxiliary Equipment.
- vii. Spares and Tools shall be made available before STW of the Main and Auxiliary Equipment.
- viii. First charge of Oils, coolants, and Greases for the equipment and items shall be supplied before STW of the Main and Auxiliary Equipment.

	MAZAGON DOCK SHIPBUILDERS LTD., (A Govt. of India Undertaking) Dockyard Road, Mumbai - 400 010.	DESIGN OUTFIT	TSP. NO.	SB/D-F/ MPV/2028
			REV. NO.	2
		TECHNICAL REQUIREMENTS FOR ANCHOR WINDLASS AND MOORING WINCHES	DATE	12/03/2024
			PAGE NO.	Page 17 of 23

- ix. Preservatives for all mounts shall be supplied along with the mountings.
- x. Preservatives required for preservation of the equipment & items (shall be delivered along with Main Equipment).
- xi. Flushing procedure, required to flush the system on board the ship (shall be delivered along with Main Equipment).
- xii. Special Tools, items etc. required to carry out preservation of Main and Auxiliary Equipment at Yard or on Board the ship (shall be brought by the supplier for carrying out preservation on board the ship).
- xiii. Documentation in hard as well as soft copies shall be delivered along with Main Equipment for each ship set as detailed in the Para. 9 above.
- xiv. Details of pump/motor/starter.
- xv. **Communication cables** like CAT, optical fibre cables are to supplied by the vendor if required in design of the equipment.
- xvi. **Cable tallies** required by the system should be supplied along with main equipment for shipyard use as per class guidelines.
- xvii. **UPS and batteries** along with enclosures should be supplied along with main equipment. , if required in the design of the equipment.
- xviii. Provision for external alarms and other important indications should be catered as per class rules.
- xix. Asbestos free construction certificates (Green Passport)
- xx. Motors above 3 KW, as applicable, shall be procured only from ABB, Hoyer & Siemens.
- xxi. Starters should be for reducing starting current of system. Starters should include protective devices for motors.

 <p>MAZAGON DOCK SHIPBUILDERS LTD., (A Govt. of India Undertaking) Dockyard Road, Mumbai - 400 010.</p>	DESIGN OUTFIT	TSP. NO.	SB/D-F/ MPV/2028
		REV. NO.	2
	TECHNICAL REQUIREMENTS FOR ANCHOR WINDLASS AND MOORING WINCHES	DATE	12/03/2024
		PAGE NO.	Page 18 of 23

TECHNICAL REQUIREMENTS:

1. ANCHOR WINDLASS/ MOORING WINCHES

- 2 nos. – Continuous duty pull 10.25 tonne/7.47 tonne x 9/15 m/min, short term pull 15.38 tonne suitable for chain dia 46 mm stud link chain K3 grade on forecastle deck of the vessel (1-gypsy wheel, 2-hawser drums and 1-warping head, each).
- Electric type

2. MOORING WINCHES

- 2 nos. – 7.47 tonne x 15 m/min on the poop deck aft (1- hawser drums and 1-warping head, each).
 - Electric type
- i. The drums shall be of declutch-able split type with manual spindle band brake and capable of stowing 180m long, 48 mm diameter long fiber rope on stowage part of drum. Drums also shall be with suitable capacity for maximum 3 layers rope at working part.
 - ii. Each drum and gypsy wheel shall be provided with an individual mechanical declutch- able claw clutch and linked with hand brake. The brake drum and surface to be SUS 316. A ratchet roller chain stopper with lashing hook shall be provided. Lashing hook to be by means of chain. The chain stopper to be closed with stopper plate when anchor is housed.
 - iii. The warping end to be with no whelp and be directly connected with driving shaft without clutching device.
 - iv. Chain drum and hawser drum shall not be operated simultaneously. Each hawser drum of windlass shall not be operated simultaneously.
 - v. The speed and driving direction of each windlass & mooring winch shall be controlled by local control valve.
 - vi. The windlass and mooring winch shall be applied with resin chock/steel liner according to the Builder's practice.
 - vii. SUS316 shall be used for all exposed bolts, nuts, washers, etc. Above M20, hot-dip galvanized may as well. All exposed pipe/hose fittings shall be SUS316L and wrapped in Denso tape'. Noted that the specification wording is removed considering electric type. However shall suggest to retain the

	MAZAGON DOCK SHIPBUILDERS LTD., (A Govt. of India Undertaking) Dockyard Road, Mumbai - 400 010.	DESIGN OUTFIT	TSP. NO.	SB/D-F/ MPV/2028
			REV. NO.	2
		TECHNICAL REQUIREMENTS FOR ANCHOR WINDLASS AND MOORING WINCHES	DATE	12/03/2024
			PAGE NO.	Page 19 of 23

same considering foreseen pipe for exposed electrical cables, if any

- viii. Operation by remote controls shall be provided for deck machinery. Proper protection of the crew to be ensured in case of mooring rope failure.
- ix. Non-skid painting or equivalent anti slip protection shall be provided around motor side, winch side and shipside control stands.
- x. Electrical power supply of 3 x 400 V and 1 x 220 V at 50 Hz.
- xi. The construction, material, accessories, spares and tools shall be in accordance with the manufacturer's standard.
- xii. One (1) canvas cover shall be provided for control stand of windlasses and mooring winches, drums of mooring winches.

	MAZAGON DOCK SHIPBUILDERS LTD., (A Govt. of India Undertaking) Dockyard Road, Mumbai - 400 010.	DESIGN OUTFIT	TSP. NO.	SB/D-F/ MPV/2028
			REV. NO.	2
		TECHNICAL REQUIREMENTS FOR ANCHOR WINDLASS AND MOORING WINCHES	DATE	12/03/2024
			PAGE NO.	Page 20 of 23

ANNEXURES



MAZAGON DOCK SHIPBUILDERS LTD.,
(A Govt. of India Undertaking)
Dockyard Road, Mumbai - 400 010.

DESIGN OUTFIT
TECHNICAL REQUIREMENTS FOR
ANCHOR WINDLASS AND
MOORING WINCHES

TSP. NO.	SB/D-F/ MPV/2028
REV. NO.	2
DATE	12/03/2024
PAGE NO.	Page 22 of 23

ANNEXURE: 2

WEIGHT CONTROL DATA SHEET

EQUIPMENT DESCRIPTION	EQUIPMENT NO.
COMPARTMENT	LOCATION

TOLERANCE CODE
 PRELIMINARY EST.
 DESIGN EST.
 BOM. (CALC)
 WEIGHED
 TOLERANCE ± %

1. WEIGHT (Kg.)

(a)	DRY	Kg ±	%
(b)	FLUID	Kg ±	%
(c)	OPERATING	Kg ±	%
(d)	TEST	Kg ±	%
(e)	TOTAL	Kg ±	%

2. EQUIPMENT DIMENSIONAL DATA (mm).

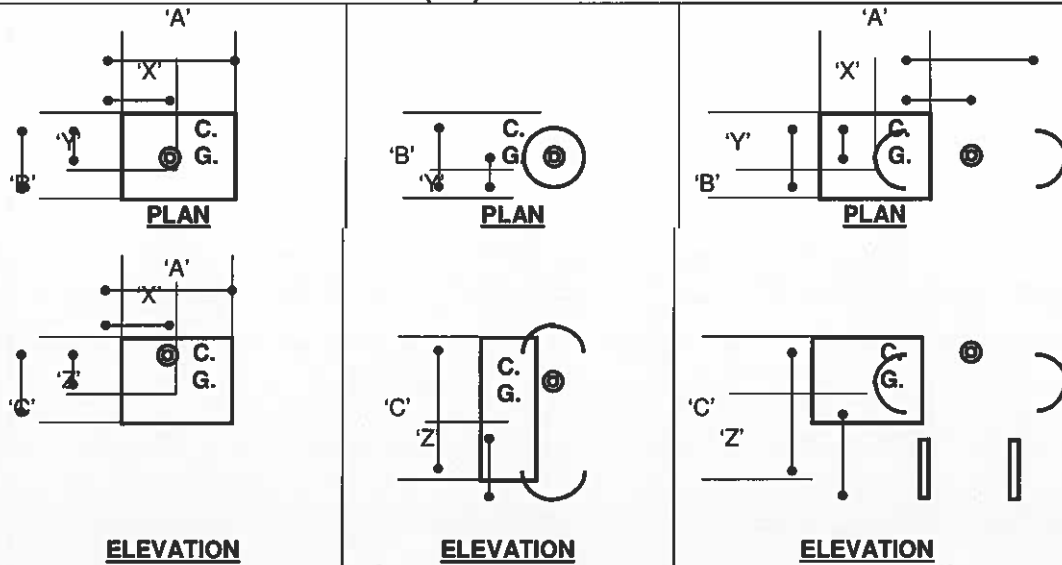

OVERALL SIZE		CENTRE OF GRAVITY	
'A'		'X'	
'B'		'Y'	
'C'		'Z'	

NOTE :

- ALL OFFERS MUST INCLUDE THIS DATA SHEET DULY FILLED IN BY THE VENDOR (SIGNED, DATED & SEAL AFFIXED).
- ALL FINISHED ITEMS SHALL BE WEIGHED & A CERTIFICATE SHALL BE PROVIDED AS PER ATTACHED SHEET.
- SEPARATE SHEETS TO BE COMPLETED FOR EACH INSTALLED EQUIPMENT.
- ORIGIN OF 'X', 'Y' AND 'Z' TO BE INDICIATED.

VENDOR'S SEAL

VENDOR'S SIGNATURE & DATE

	MAZAGON DOCK SHIPBUILDERS LTD., (A Govt. of India Undertaking) Dockyard Road, Mumbai - 400 010.	DESIGN OUTFIT	TSP. NO.	SB/D-F/ MPV/2028
		TECHNICAL REQUIREMENTS FOR ANCHOR WINDLASS AND MOORING WINCHES	REV. NO.	2
			DATE	12/03/2024
			PAGE NO.	Page 23 of 23

ANNEXURE: 3

WEIGHT CERTIFICATE

EQUIPMENT DESCRIPTION :	EQUIPMENT NO. :
--------------------------------	------------------------

The form has to be completed by Supplier & to be supplied along with the equipment.

SUPPLIER'S NAME		Ref. Drg. No.	
ADDRESS		Part No.	
TELEPHONE NO.		EQPT. NO.	
ORDER NO.			

METHOD OF WEIGHING :
Supplier to prescribe Method & Equipment Used :

	DATE OF LAST CALIBRATION	SPECIFIED ACCURACY REQUIREMENT
NOTE :-		

RESULT OF WEIGHING TOTAL EQUIPMENT DRY WEIGHT
(Excluding packing, temporary protection etc.)

ALLOCATED WEIGHT
(Weight estimate agreed by purchaser and supplier based on order specs).

REASONS FOR VARIATION BETWEEN ALLOCATED WEIGHT AND CERTIFIED WEIGHT :

WEIGHING ADDRESS :	WITNESSED BY	
	FOR SUPPLIER	FOR PURCHASER
	Representative	Representative
Date :	Signature / Date & Seal	Signature/Date & Seal